

BURE

Variabel geometrisch plafondrooster

Gebruikershandleiding

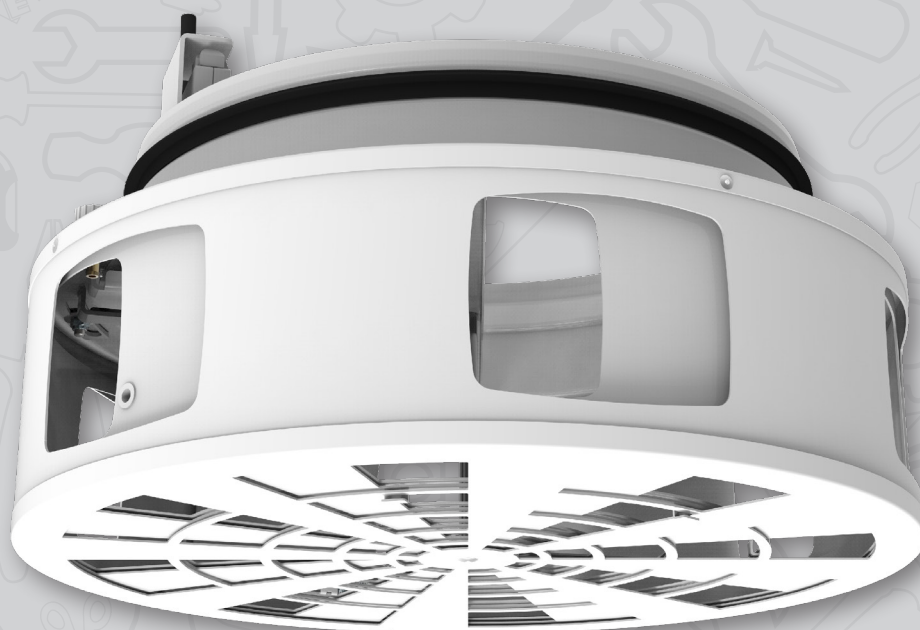



BURE-HC



BURE-M2

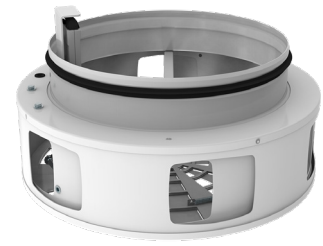

BURE-MC



1.

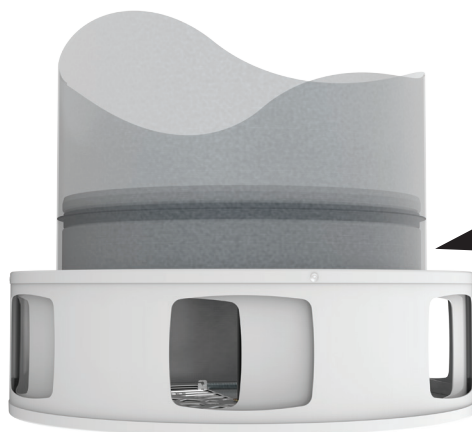

3 × Ø 3,5 mm

2.

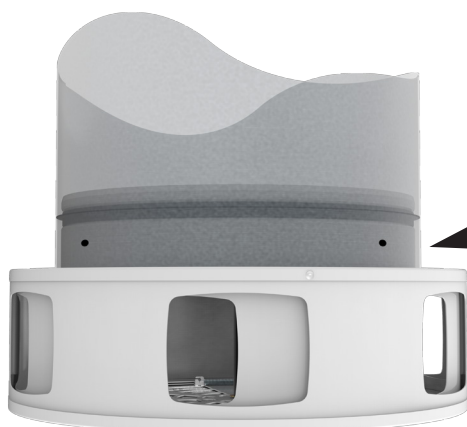

3 × Ø 4 mm

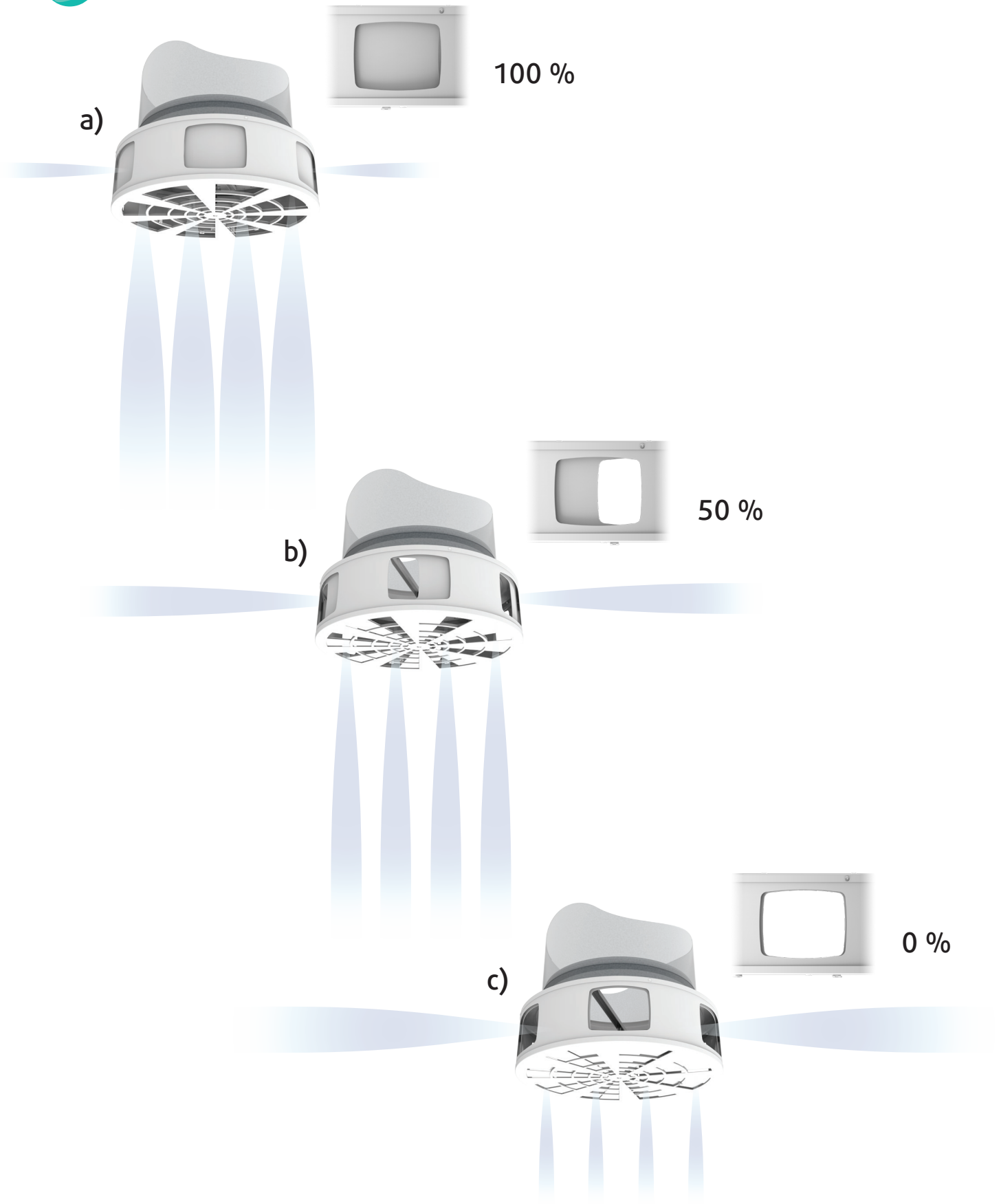



BURE...

-HC

-M2

-MC

-HC

P5... P3 ... P1

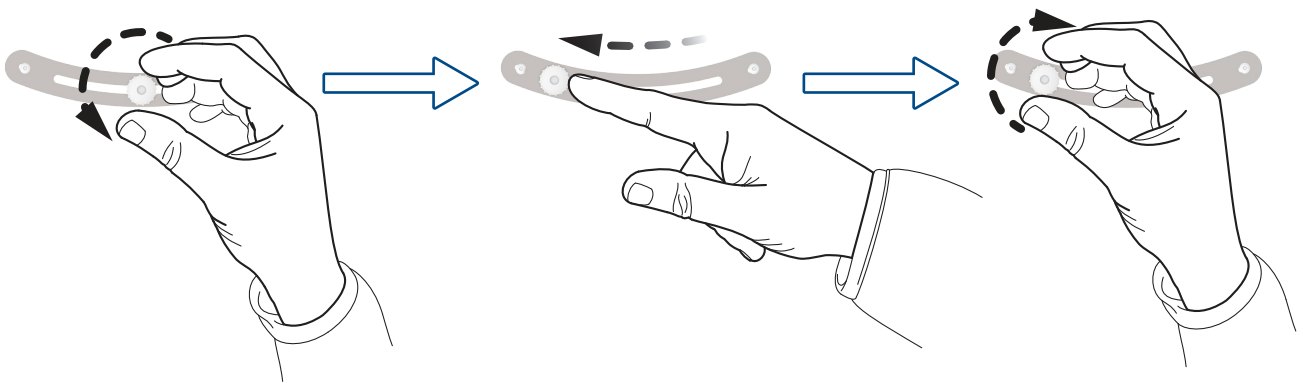

-M2

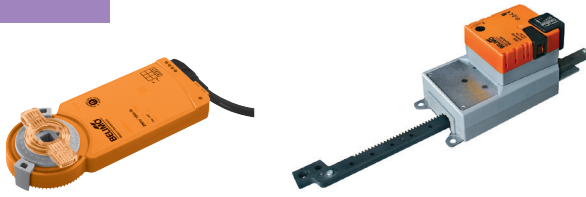

CM230-F10-L / LH230A100

BURE-M2-250
BURE-M2-315

BURE-M2-400
BURE-M2-500
BURE-M2-630

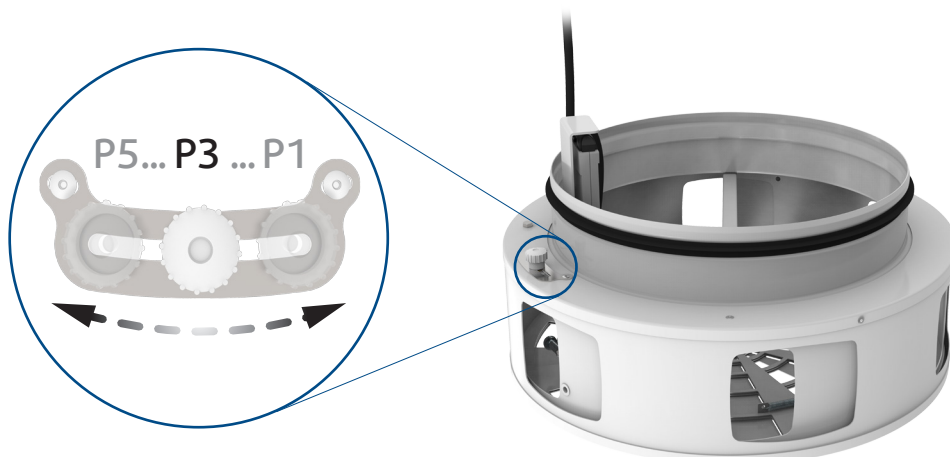
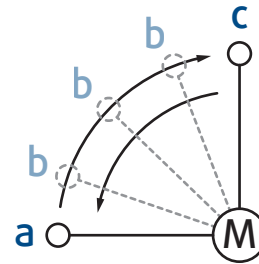
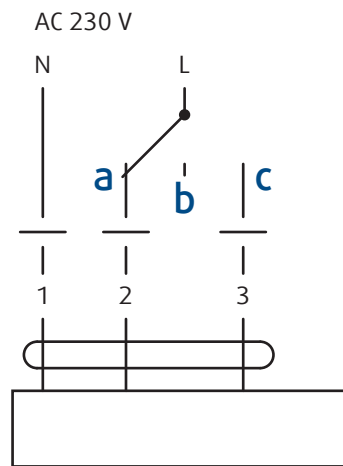
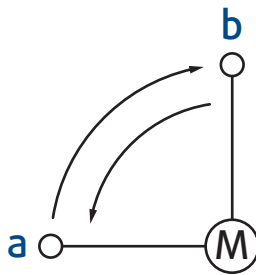
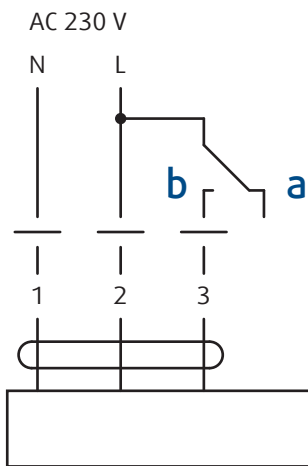

-M2

P5 ... P3

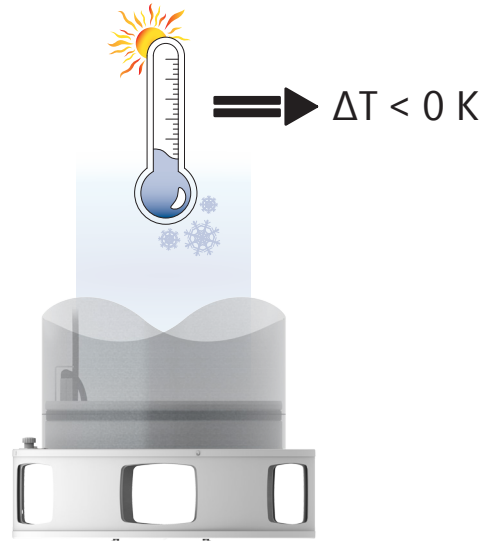
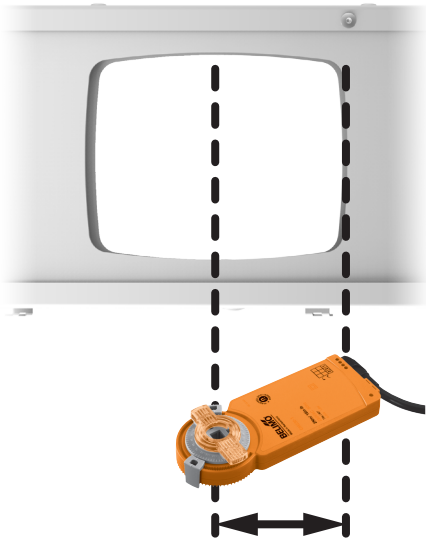

P4 ... P2

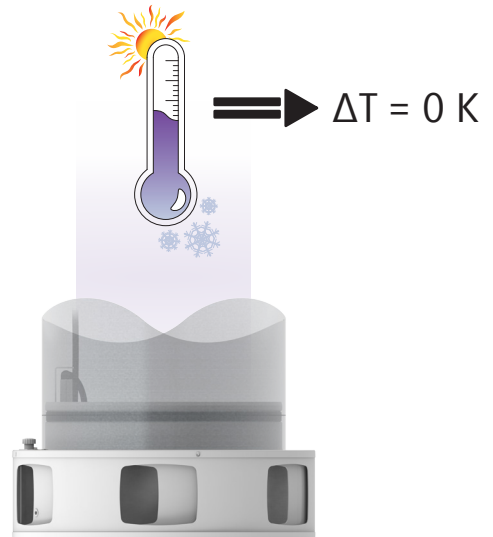
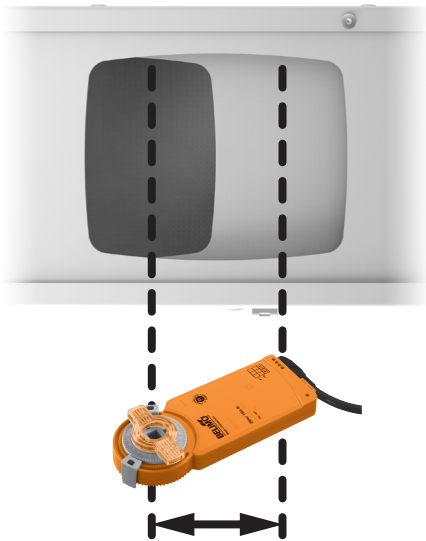

P3 ... P1

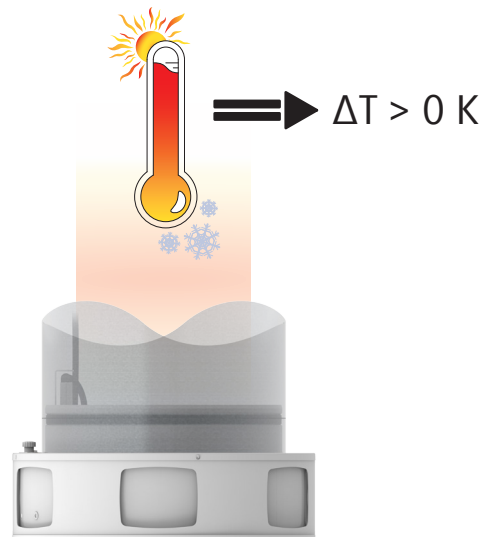
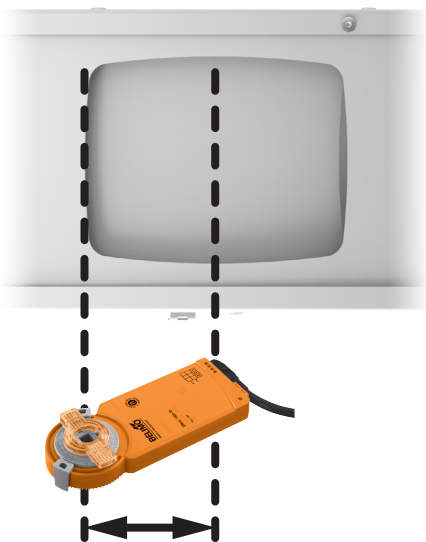

-MC



CM24-SR-F10

BURE-MC-250
BURE-MC-315

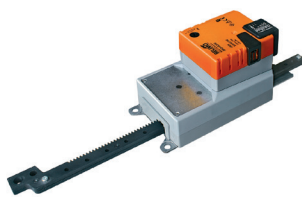

LH24A-MF100

BURE-MC-400

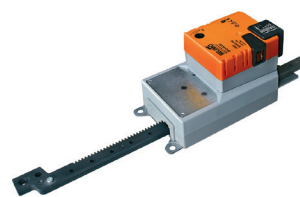

LH24A-MF200

BURE-MC-500
BURE-MC-630

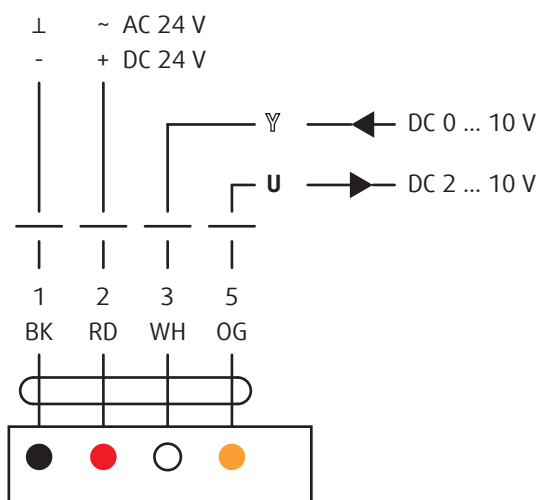

Y = 10 V



Y = 5 V



Y = 0 V



°C -40°C ... +80°C

% ≤ 95%



°C -10°C ... +50°C

% ≤ 95%

