

CFC-A  
Clean Filtering Cassette  
Handbook

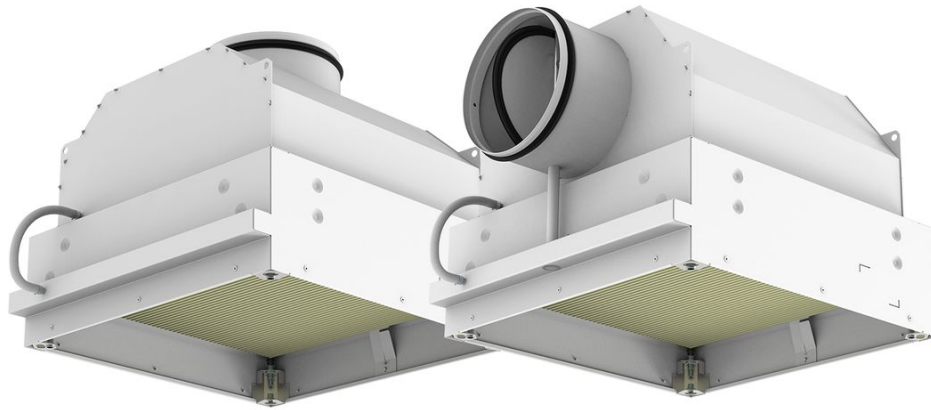

# Table of Contents

Description . . . . .	.3
Dimensions & Weights . . . . .	.5
Ordering Codes . . . . .	.6
Accessories . . . . .	.7
Quick Selection . . . . .	.13
Technical Parameters . . . . .	.15
Installation . . . . .	.30
Maintenance . . . . .	.35
Transport, Storage and Operation . . . . .	.36
Supplement . . . . .	.37



## Description

CFC-A is a cassette used as a terminal device for ventilation with high efficiency particulate filter. It is mainly intended for ventilation of spaces with requirements for high grade of air cleanness like surgery rooms and medical intensive care units, laboratories, industrial clean production sites etc.

CFC-A can be used for air supply as well as for air extract.

### Highlights

- Version with air tight shut-off damper available
- Safe handling of the damper from the room side
- Adaptability for multiple types of ceiling installation
- Different sizes of duct connection available for each filter size

### Product Types

- CFC-A-...-V: Clean filtering cassette with vertical connection
- CFC-A-...-V...-D: Clean filtering cassette with vertical connection, with a damper
- CFC-A-...-H: Clean filtering cassette with horizontal connection
- CFC-A-...-H...-D: Clean filtering cassette with horizontal connection, with a damper

### List of Accessories

- PP-CFC-A, CAP-CFC-A, ADQ-CFC-A, VVKR-CFC-A, VVKN-CFC-A: Front Diffuser Panels
- APS..., APT..., APG: Adapter Ledges
- CFC-HF-14: Filter

## Design

CFC-A is made from carbon steel sheet. The casing is spot welded and hermitized by polymer sealant. CFC-A is available with an air-tight shut-off damper situated in the circular duct connection, manually operable from the room side of the cassette in version with horizontal connection and on connection side with the vertical connection. The casing is air-tight on the duct connection side as well as on the room side. The air tightness of the casing and the closed damper is tested under static pressures of up to 600 Pa by the soap bubble method, eventually by the smoke method.

High efficiency filters of the class from E11 up to U18 can be used with CFC-A. A plain sealing surface is prepared in the cassette to attach the single or double row D-profile gasket of the filter.

The cassette is equipped by a pressure measurement nipple for the measurement of the actual filter resistance (clogging detection). The duct connection spigot has a gasket from EPDM.

### Product Parts

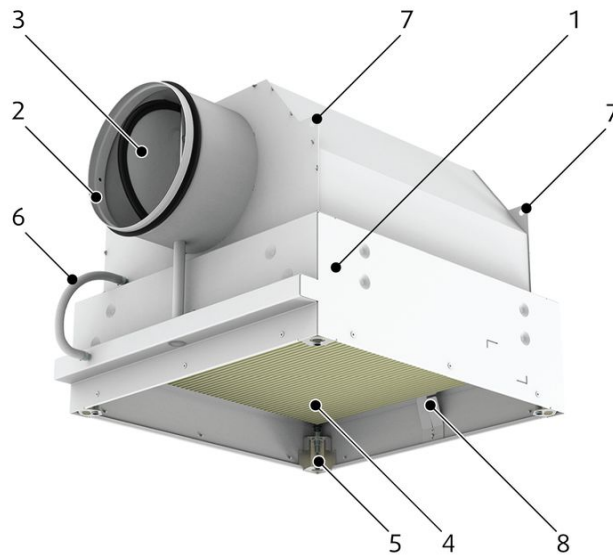

### Legend

- 1 Casing
- 2 Duct connection with gasket
- 3 Air-tight damper with gasket
- 4 Filter
- 5 Fixing bracket for filter and for front diffuser panel
- 6 Impulse tube for measurement of the filter resistance
- 7 Hanging ears

# Dimensions & Weights

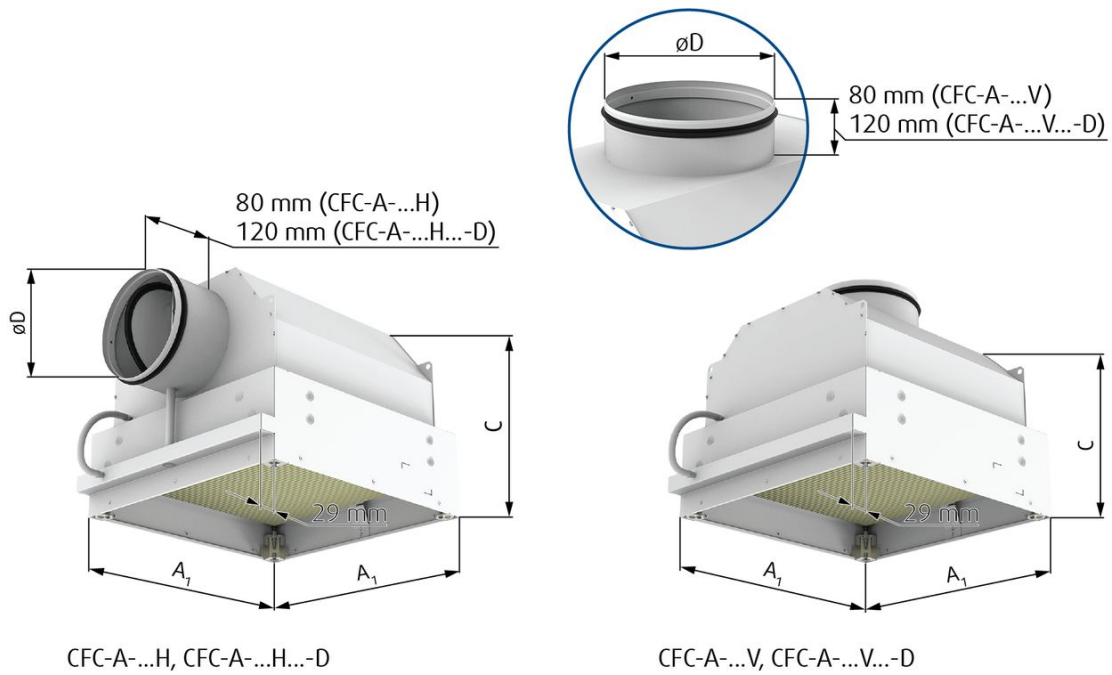

A × A × T i *1	A <sub>1</sub>	øD/DN	C
mm			
305 × 305 × 80	318	123/125	307
		158/160	342
457 × 457 × 80	470	158/160	342
		198/200	382
535 × 535 × 80	548	158/160	342
		198/200	382
557 × 557 × 80	570	198/200	382
		248/250	432
575 × 575 × 80	588	198/200	382
		248/250	432
610 × 610 × 80	623	248/250	432
		313/315	497

NOTE:

1) The nominal dimensions of CFC-A are related to exact dimensions (A × A × T) of corresponding filters.

# Ordering Codes

## Duct connection

**V** Vertical

**H** Horizontal

## Nominal dimensions (filter dimensions Length × Width × Thickness)

**305 × 305 × 80**

**457 × 457 × 80**

**535 × 535 × 80**

**557 × 557 × 80**

**575 × 575 × 80**

**610 × 610 × 80**

## Connection nominal size DN (mm) (For filter L × H)

**125** (for filter 305 × 305)

**160** (for filter 305 × 305)

**160** (for filter 457 × 457)

**200** (for filter 457 × 457)

**160** (for filter 535 × 535)

**200** (for filter 535 × 535)

**200** (for filter 557 × 557)

**250** (for filter 557 × 557)

**200** (for filter 575 × 575)

**250** (for filter 575 × 575)

**250** (for filter 610 × 610)

**315** (for filter 610 × 610)

## Damper

- No Damper

**D** Gas-tight shut-off damper in the duct connection

## Surface finish

**SW** Signal white (RAL9003, gloss 30%)

**RALXXXX** Other colour powder coating

## Example of Ordering Code

**CFC-A-H-610x610x80-315-D-SW**

Clean filtering cassette for filter size 610 mm × 610 mm × 80 mm, with horizontal connection DN 315 mm, equipped by gas-tight damper. The product has signal white RAL9003 surface finish.

# Accessories

## PP-CFC-A, CAP-CFC-A, ADQ-CFC-A, VVKR-CFC-A, VVKN-CFC-A

### Front Diffuser Panels



### Description

**PP-CFC-A** Perforated diffuser panel mainly intended for air extract

**CAP-CFC-A** Multi nozzle diffuser panel for variable supply air patterns

**ADQ-CFC-A** Diffuser panel with fixed blades for horizontal supply air discharge pattern

**VVKR-CFC-A** Diffuser panel with adjustable blades for variable swirl supply air discharge pattern

**VVKN-CFC-A** Diffuser panel with fixed blades for horizontal swirl supply air discharge pattern

### Dimensions

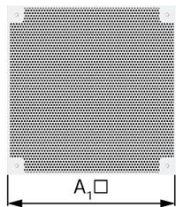

PP-CFC-A

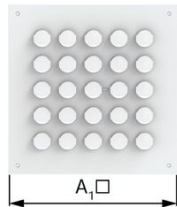

CAP-CFC-A

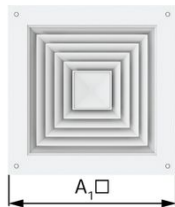

ADQ-CFC-A



VVKR-CFC-A

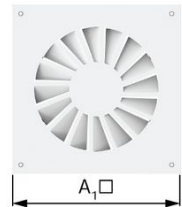

VVKN-CFC-A

A × A	A <sub>1</sub>
mm	
305 × 305	318
457 × 457	470
535 × 535	548
557 × 557	570
575 × 575	588
610 × 610	623

## Ordering Codes

### Front diffuser panel type

**PP-CFC-A** Perforated panel

**CAP-CFC-A** Multi-nozzle panel

**ADQ-CFC-A** Fixed deflectors panel

**VVKR-CFC-A** Swirl panel with adjustable blades

**VVKN-CFC-A** Swirl panel with fixed blades

### Nominal dimensions (filter dimensions length × width)

305 × 305

457 × 457

535 × 535

557 × 557

575 × 575

610 × 610

### Surface finish

**SW** Signal white (RAL9003, gloss 30%)

**RALXXXX** Other colour powder coating

NOTE:

1) If no Surface finish is defined, RAL9003 will be delivered.

### Example of Ordering Code

**CAP-CFC-A-610×610-SW**

Multi-nozzle front diffuser panel for clean filtering cassette size 610 mm × 610 mm, RAL9003 powder paint.



**APS..., APT..., APG...**

## Adapter Ledges

**Description**

The adapter ledges help to adapt the dimensions for installation of the CFC-A box into the gypsum plaster ceilings, metal plate ceilings or into the T-bar ceilings (see ceiling type, raster in the ordering code).

**Design**

The ledges are manufactured from galvanized steel sheet with the same surface finish as the one chosen for the clean filtering cassette (powder paint in RAL9003, eventually other RAL colour).

**Dimensions**

The inner opening size of the ledge corresponds to the filter dimensions in the filter cassette. The outer dimensions of the ledge correspond to the raster size of the ceiling (600 mm or 625 mm) for the metal plate and T-bar ceilings or extend 50 mm from the inner opening for the plaster board ceilings.

The adapter ledge can be used only for selected sizes and types of CFC-A in combination with selected raster and types of the suspended ceilings (see dimension table for CFC-A filter cassettes).

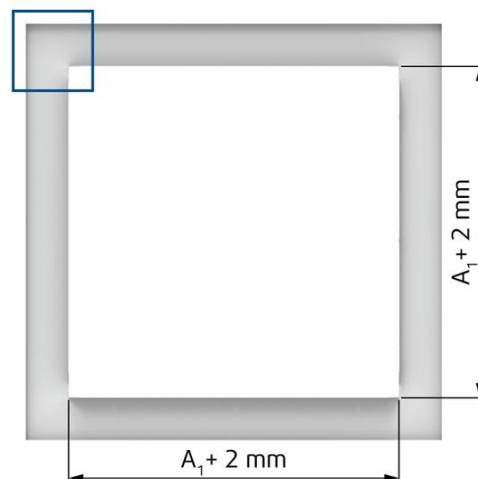

APS...



APT...

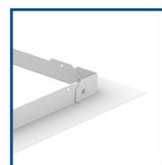

APG

## Ordering Codes

### Type of ceiling adapter frame

**APS625-CFC-A** For metal plate ceiling raster 625

**APS600-CFC-A** For metal plate ceiling raster 600

**APT625-CFC-A** For T-bar ceiling raster 625

**APT600-CFC-A** For T-bar ceiling raster 600

**APG-CFC-A** For plaster board ceiling

### Nominal dimensions (filter dimensions length × width) <sup>1</sup>

305 × 305

457 × 457

535 × 535

557 × 557

575 × 575

### Surface finish

**SW** Signal white (RAL9003, gloss 30%)

**RALXXXX** Other colour powder coating

### NOTES:

1. APT600 and APS600 available only up to size 557 mm × 557 mm.

APT625 and APS625 available only up to size 575 mm × 575 mm.

### Example of Ordering Code

**APT600-CFC-A-535×535-SW**

Ceiling adapter for clean filtering cassette size 535 mm × 535 mm, RAL9003 powder paint.

**CFC-HF-14**

Filter

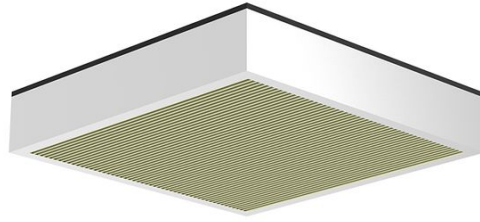
**Description**

HEPA filter class H14 with polyurethane gasket is intended for the clean filtering cassettes. It is a standard initial equipment for CFC-A...

**Design**

The filtering media with protective wire mesh from one side is installed in anodized aluminium frame. A D-shaped polyurethane gasket is adhered to the frame, prepared for flat sealing area of the filter cassette. The pressure drop on the filter cannot exceed the limit of 500 Pa.

**Dimensions**

Nominal dimensions of the filters ( $A \times A \times T$ ) correspond to the clean filtering cassettes nominal dimensions (see dimension table for CFC-A... filtering cassettes). The filter nominal thickness is 80 mm and real thickness of the filter frame is 78 mm plus the thickness of the gasket, which is up to 5 mm when installed in the filtering cassette.

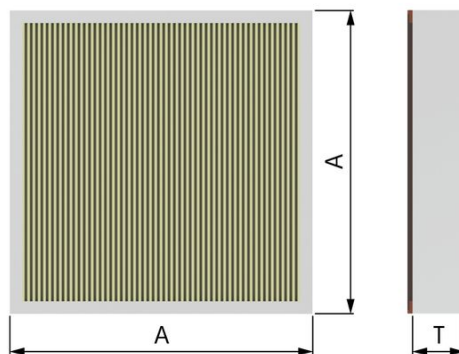

### Ordering Codes

#### Filter type

**CFC-HF-14**

#### Filter dimensions <sup>1)</sup>

**A×A×T** length × width × thickness (mm)

NOTE: **1)** Filter dimensions A × A correspond to the nominal dimensions of the cassette. See CFC-A dimension table

#### Example of Ordering Code

**CFC-HF-14-305x305x80**

HEPA filter with rubber gasket, filter class H14, with dimensions 305 mm × 305 mm, thickness 80 mm.

# Quick Selection

Initial resistance of the standard H14 filter CFC-HF-14... with thickness 78 mm at different air face velocities. The pressure drop on the filter cannot exceed the limit of 500 Pa.

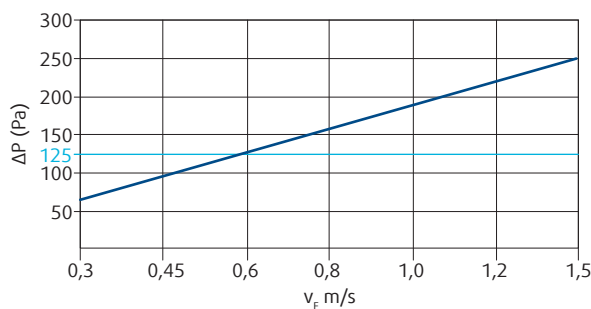

Quick selection with limitation of critical values, combinations of the clean filter cassettes CFC-A and diffuser panels

		305 × 305 × 80	457 × 457 × 80	535 × 535 × 80	557 × 557 × 80	575 × 575 × 80	610 × 610 × 80
PP-CFC-A	q (m <sup>3</sup> /h)	70	100	150	220	330	375
	$\Delta P$ (Pa)	36	34	36	49	71	75
	$L_{WA}$ (dB)	23	22	<20	21	21	23
	$L_{0,2V}$ (m)	2,0 *	2,0 *	2,0 *	2,0 *	2,0 *	2,0 *
CAP-CFC-A	q (m <sup>3</sup> /h)	150	200	290	375	375	465
	$\Delta P$ (Pa)	120	77	82	100	90	102
	$L_{WA}$ (dB)	35 *	35 *	35 *	35 *	35 *	35 *
	$L_{0,2H}$ (m)	3,0	2,5	2,7	2,3	2,3	2,5
ADQ-CFC-A	q (m <sup>3</sup> /h)	190	270	270	375	375	375
	$\Delta P$ (Pa)	69	81	67	78	73	69
	$L_{WA}$ (dB)	28	22	<20	22	22	22
	$L_{0,2H}$ (m)	4,0 *	4,0 *	4,0 *	4,0 *	4,0 *	4,0 *
VVKR-CFC-A	q (m <sup>3</sup> /h)	155	360	520	520	625	625
	$\Delta P$ (Pa)	126	141	153	148	161	147
	$L_{WA}$ (dB)	28	33	34	34	35 *	35 *
	$L_{0,2H}$ (m)	3,0 *	3,0 *	3,0 *	3,0 *	2,6	2,6
VVKN-CFC-A	q (m <sup>3</sup> /h)	150	265	434	434	434	545
	$\Delta P$ (Pa)	127	102	125	111	111	117
	$L_{WA}$ (dB)	35 *	35 *	35 *	35 *	35 *	31
	$L_{0,2H}$ (m)	2	2,4	3,2	3,2	3,2	4,0 *

NOTE: \* Limiting value significant for the chosen working point.

$L_{0,2H}$  Horizontal throw length with terminal velocity 0,2 m/s

$L_{0,2V}$  Vertical throw length with terminal velocity 0,2 m/s

Quick selection of working points with  $\Delta P = 150$  Pa, combinations of the clean filter cassettes CFC-A and diffuser panels

		305 × 305 × 80	457 × 457 × 80	535 × 535 × 80	557 × 557 × 80	575 × 575 × 80	610 × 610 × 80
PP-CFC-A	q (m <sup>3</sup> /h)	257	420	548	596	641	703
	L <sub>WA</sub> (dB)	33	38	35	36	37	37
	L <sub>0,2H</sub> (m)	7,4	7,7	7,1	5,3	3,8	3,7
CAP-CFC-A	q (m <sup>3</sup> /h)	184	356	505	543	587	652
	L <sub>WA</sub> (dB)	41	53	52	46	48	45
	L <sub>0,2H</sub> (m)	5,6	6,9	7,1	5,2	5,6	5,3
ADQ-CFC-A	q (m <sup>3</sup> /h)	400	500	600	700	750	800
	L <sub>WA</sub> (dB)	25	27	26	27	28	30
	L <sub>0,2H</sub> (m)	8,4	7,3	8,8	7,5	8	8,5
VVKR-CFC-A	q (m <sup>3</sup> /h)	183	382	512	525	594	638
	L <sub>WA</sub> (dB)	33	35	34	34	33	36
	L <sub>0,2H</sub> (m)	3,5	3,1	3	3,1	2,4	2,6
VVKN-CFC-A	q (m <sup>3</sup> /h)	174	373	504	537	557	678
	L <sub>WA</sub> (dB)	38	47	40	41	43	40
	L <sub>0,2H</sub> (m)	2,1	3,4	3,7	4	4,1	5

L<sub>0,2H</sub> Horizontal throw length with terminal velocity 0,2 m/s

L<sub>0,2V</sub> Vertical throw length with terminal velocity 0,2 m/s

# Technical Parameters

## Legend

- $L_{0,2}$  (m) Air throw length with terminal velocity 0,2 m/s
- $L_x$  (m) Air throw length calculated for specific terminal velocity
- $x$  (m/s) Terminal velocity in range of 0,1 m/s ... 1 m/s

## Calculation of Air Throw for Different Terminal Velocities

$$L_x = L_{0,2} \cdot 0,2/x$$

Pressure drop and radiated sound power level dependent on air flow volume

Throw length with terminal velocity 0,2 m/s dependent on air flow volume

**CFC-A-H-305x305x80-125-SW + ADQ-CFC-A-305x305-SW CFC-A-H-457x457x80-160-SW + ADQ-CFC-A-457x457-SW**

Pressure drop & A-weighted sound power level in dB(A)

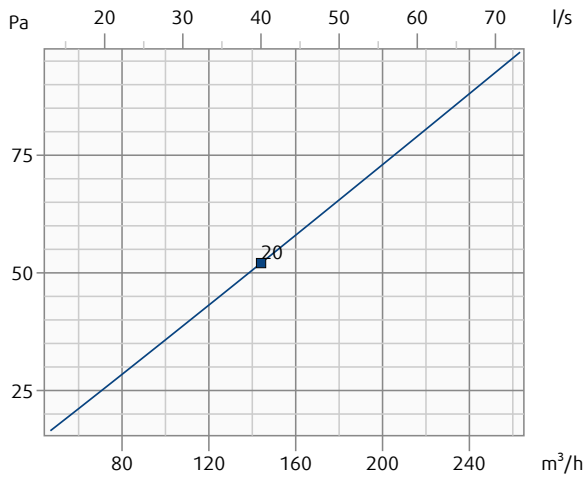

Pressure drop & A-weighted sound power level in dB(A)

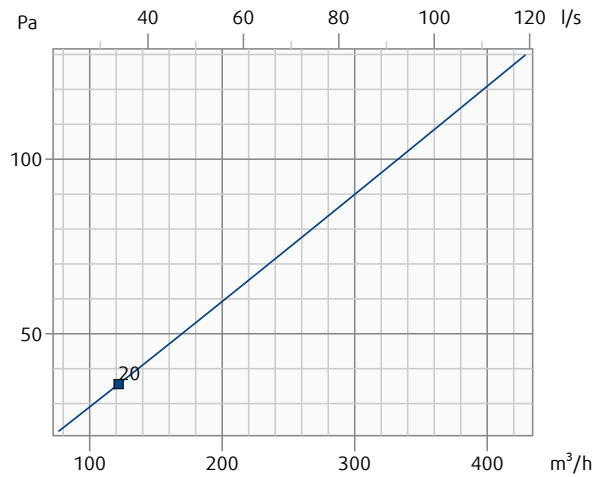

**CFC-A-H-305x305x80-125-SW + ADQ-CFC-A-305x305-SW CFC-A-H-457x457x80-160-SW + ADQ-CFC-A-457x457-SW**

Throw length (terminal velocity 0.2 m/s)

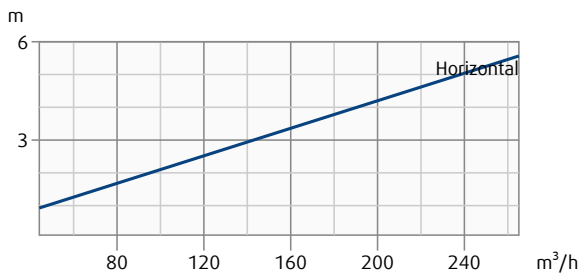

Throw length (terminal velocity 0.2 m/s)

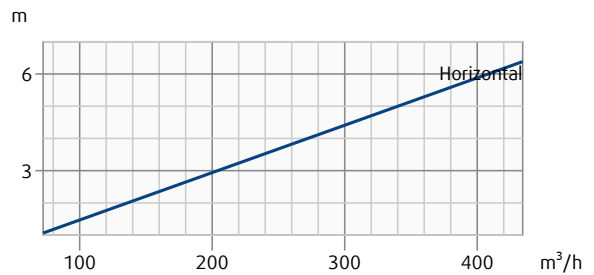

Pressure drop and radiated sound power level dependent on air flow volume

Throw length with terminal velocity 0,2 m/s dependent on air flow volume

**CFC-A-H-535x535x80-160-SW + ADQ-CFC-A-535x535-SW CFC-A-H-557x557x80-200-SW + ADQ-CFC-A-557x557-SW**

Pressure drop & A-weighted sound power level in dB(A)

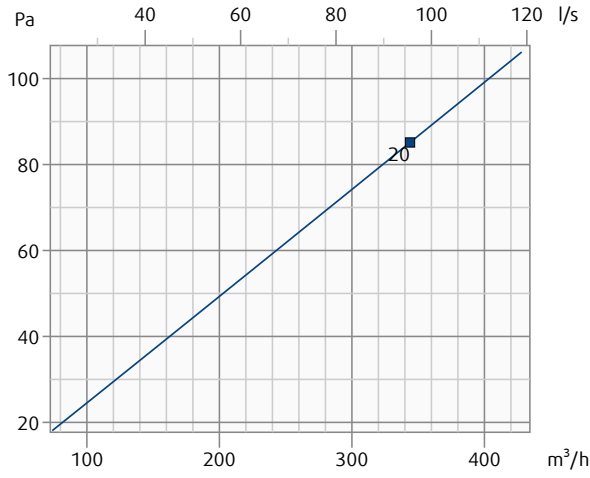

Pressure drop & A-weighted sound power level in dB(A)

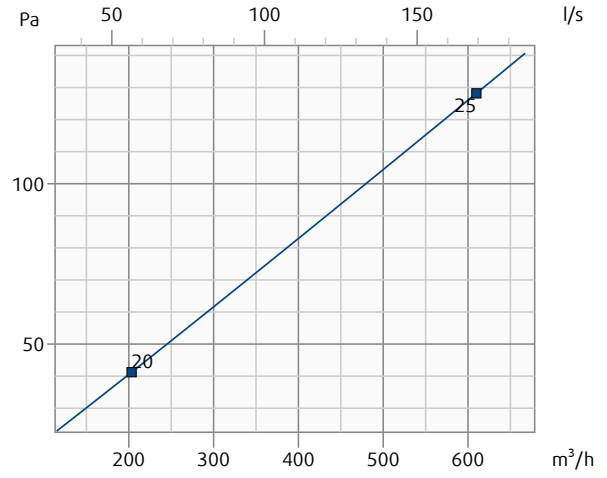

**CFC-A-H-535x535x80-160-SW + ADQ-CFC-A-535x535-SW CFC-A-H-557x557x80-200-SW + ADQ-CFC-A-557x557-SW**

Throw length (terminal velocity 0.2 m/s)

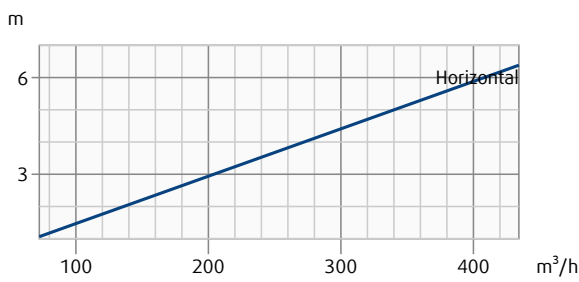

Throw length (terminal velocity 0.2 m/s)

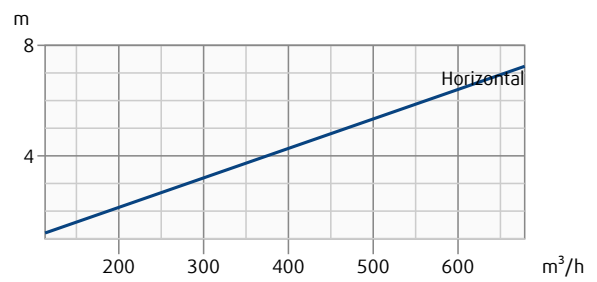



Pressure drop and radiated sound power level dependent on air flow volume

Throw length with terminal velocity 0,2 m/s dependent on air flow volume

**CFC-A-H-575x575x80-200-SW + ADQ-CFC-A-575x575-SW CFC-A-H-610x610x80-250-SW + ADQ-CFC-A-610x610-SW**

Pressure drop & A-weighted sound power level in dB(A)

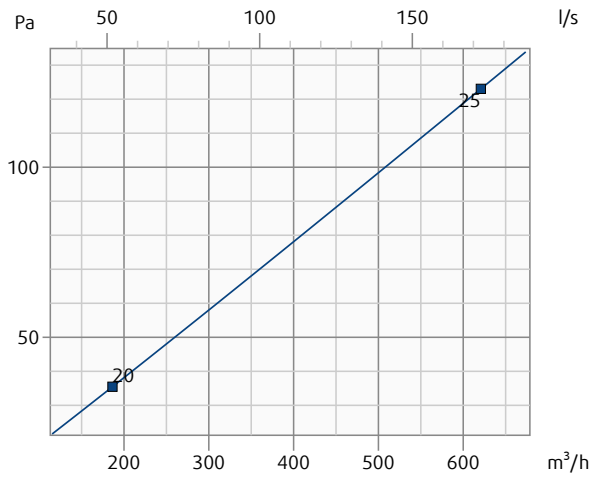

Pressure drop & A-weighted sound power level in dB(A)

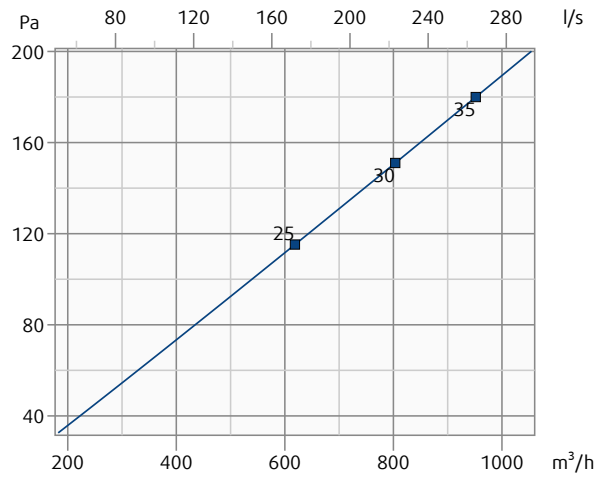

**CFC-A-H-575x575x80-200-SW + ADQ-CFC-A-575x575-SW CFC-A-H-610x610x80-250-SW + ADQ-CFC-A-610x610-SW**

Throw length (terminal velocity 0.2 m/s)

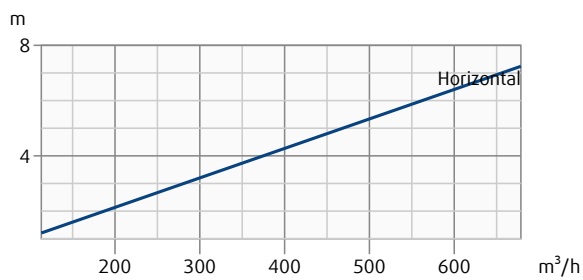

Throw length (terminal velocity 0.2 m/s)

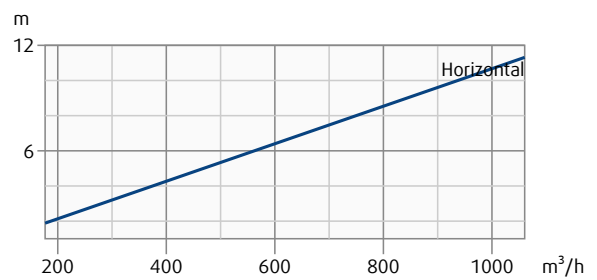

Pressure drop and radiated sound power level dependent on air flow volume

Throw length with terminal velocity 0,2 m/s dependent on air flow volume

**CFC-A-H-305x305x80-125-SW + PP-CFC-A-305x305-SW**

**CFC-A-H-457x457x80-160-SW + PP-CFC-A-457x457-SW**

Pressure drop & A-weighted sound power level in dB(A)

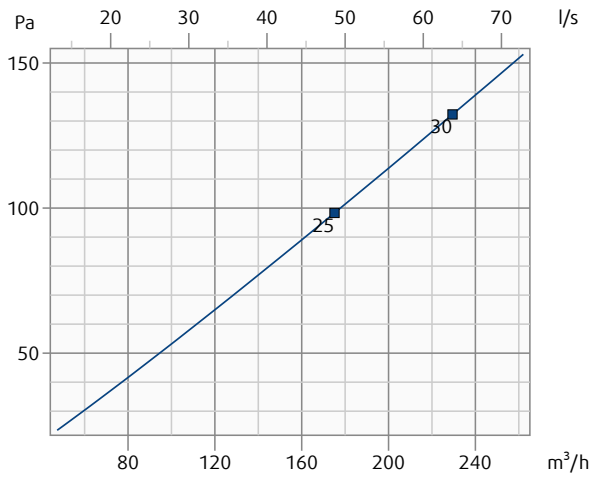

Pressure drop & A-weighted sound power level in dB(A)

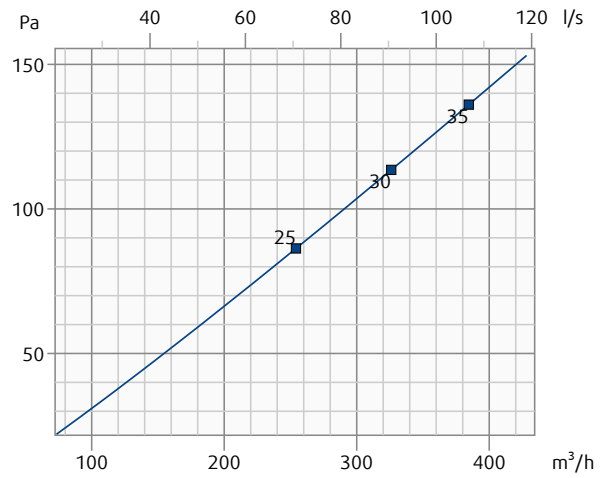

**CFC-A-H-305x305x80-125-SW + PP-CFC-A-305x305-SW**

**CFC-A-H-457x457x80-160-SW + PP-CFC-A-457x457-SW**

Throw length (terminal velocity 0.2 m/s)

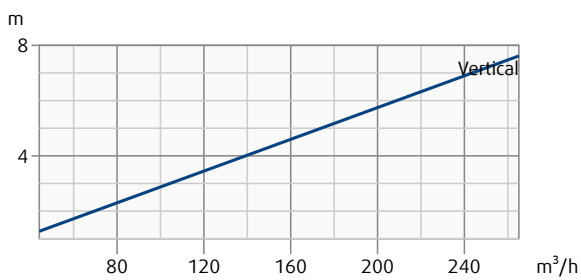

Throw length (terminal velocity 0.2 m/s)

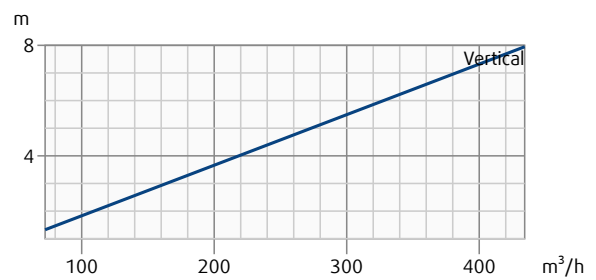

Pressure drop and radiated sound power level dependent on air flow volume

Throw length with terminal velocity 0,2 m/s dependent on air flow volume

**CFC-A-H-535x535x80-160-SW + PP-CFC-A-535x535-SW**

**CFC-A-H-557x557x80-200-SW + PP-CFC-A-557x557-SW**

Pressure drop & A-weighted sound power level in dB(A)

Pressure drop & A-weighted sound power level in dB(A)

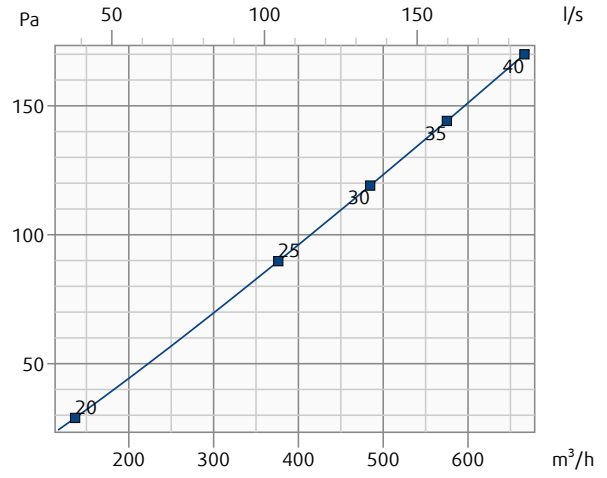
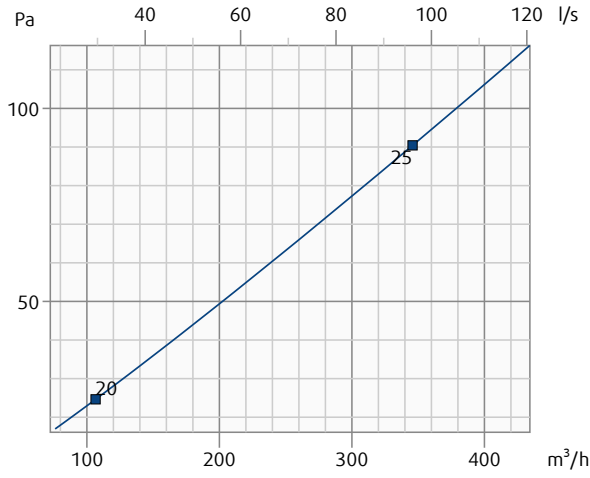

**CFC-A-H-535x535x80-160-SW + PP-CFC-A-535x535-SW**

**CFC-A-H-557x557x80-200-SW + PP-CFC-A-557x557-SW**

Throw length (terminal velocity 0.2 m/s)

Throw length (terminal velocity 0.2 m/s)

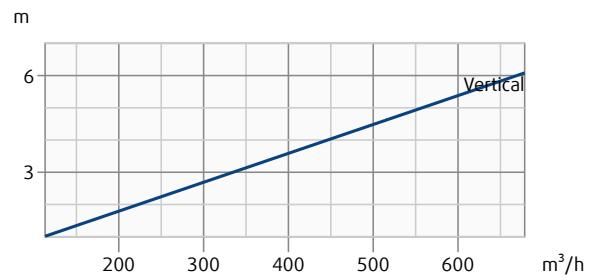
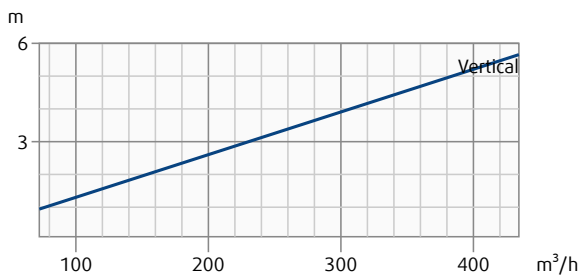

Pressure drop and radiated sound power level dependent on air flow volume

Throw length with terminal velocity 0,2 m/s dependent on air flow volume

**CFC-A-H-575x575x80-200-SW + PP-CFC-A-575x575-SW**

**CFC-A-H-610x610x80-250-SW + PP-CFC-A-610x610-SW**

Pressure drop & A-weighted sound power level in dB(A)

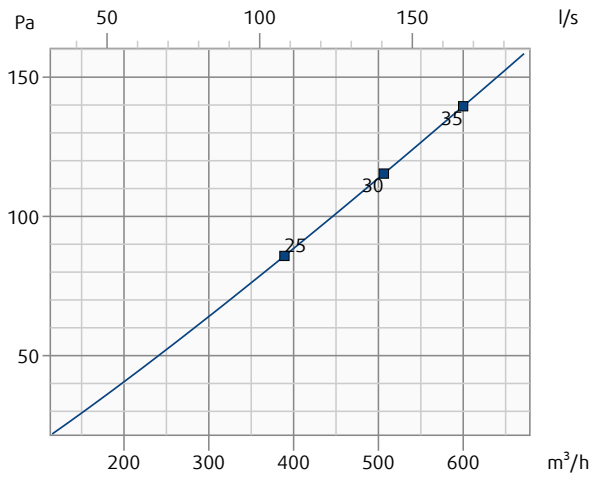

Pressure drop & A-weighted sound power level in dB(A)

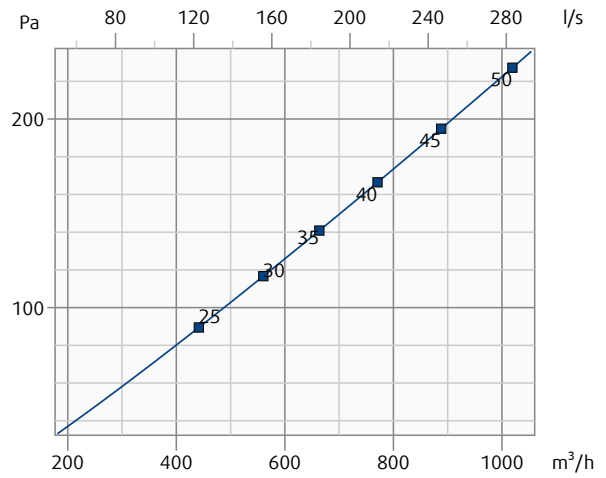

**CFC-A-H-575x575x80-200-SW + PP-CFC-A-575x575-SW**

**CFC-A-H-610x610x80-250-SW + PP-CFC-A-610x610-SW**

Throw length (terminal velocity 0.2 m/s)

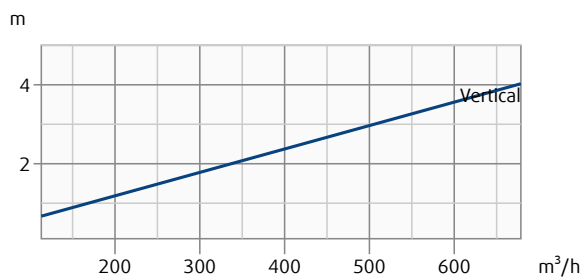

Throw length (terminal velocity 0.2 m/s)

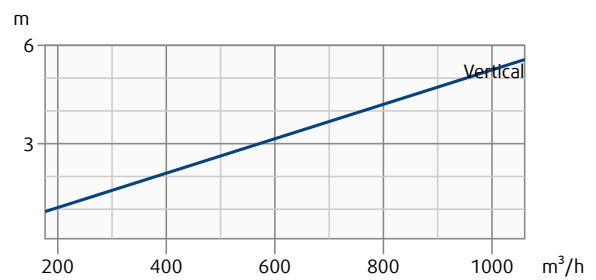

Pressure drop and radiated sound power level dependent on air flow volume

Throw length with terminal velocity 0,2 m/s dependent on air flow volume

**CFC-A-H-305x305x80-125-SW + CAP-CFC-A-305x305-SW**    **CFC-A-H-457x457x80-160-SW + CAP-CFC-A-457x457-SW**

Pressure drop & A-weighted sound power level in dB(A)

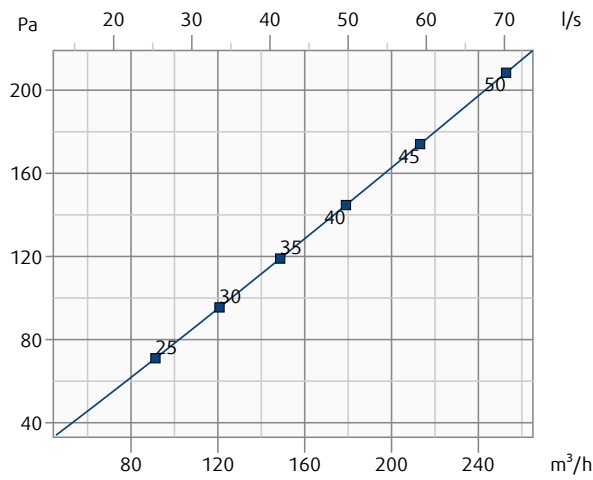

Pressure drop & A-weighted sound power level in dB(A)

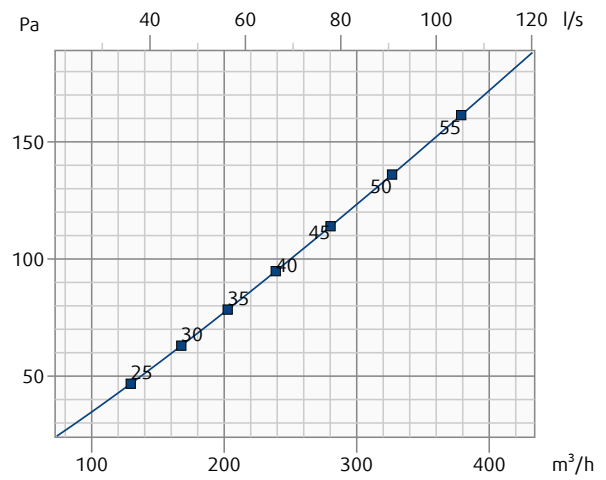

**CFC-A-H-305x305x80-125-SW + CAP-CFC-A-305x305-SW**    **CFC-A-H-457x457x80-160-SW + CAP-CFC-A-457x457-SW**

Throw length (terminal velocity 0.2 m/s)

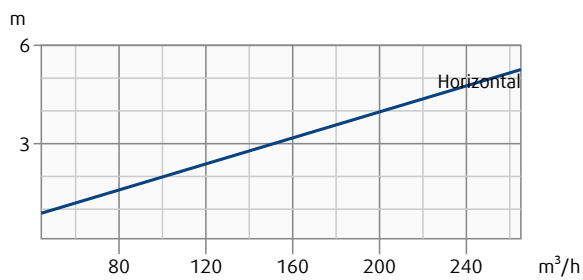

Throw length (terminal velocity 0.2 m/s)

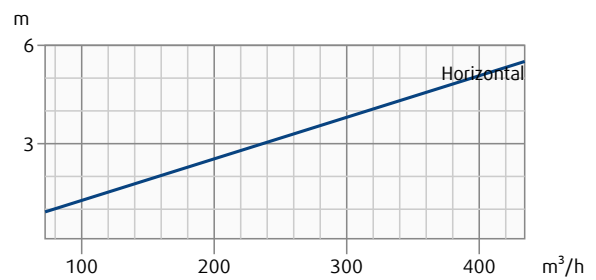

Pressure drop and radiated sound power level dependent on air flow volume

Throw length with terminal velocity 0,2 m/s dependent on air flow volume

**CFC-A-H-535x535x80-160-SW + CAP-CFC-A-535x535-SW**    **CFC-A-H-557x557x80-200-SW + CAP-CFC-A-557x557-SW**

Pressure drop & A-weighted sound power level in dB(A)

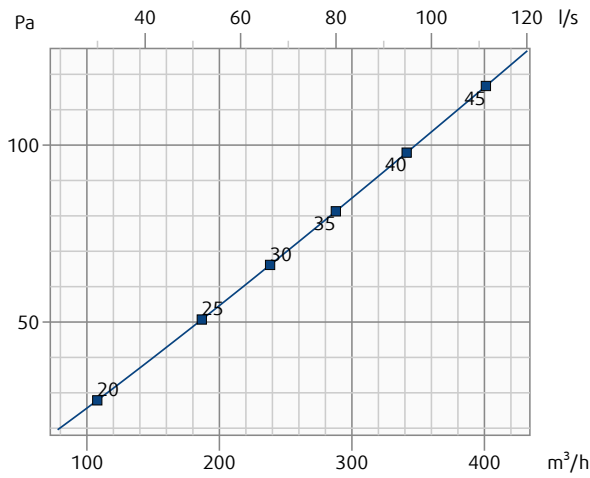

Pressure drop & A-weighted sound power level in dB(A)

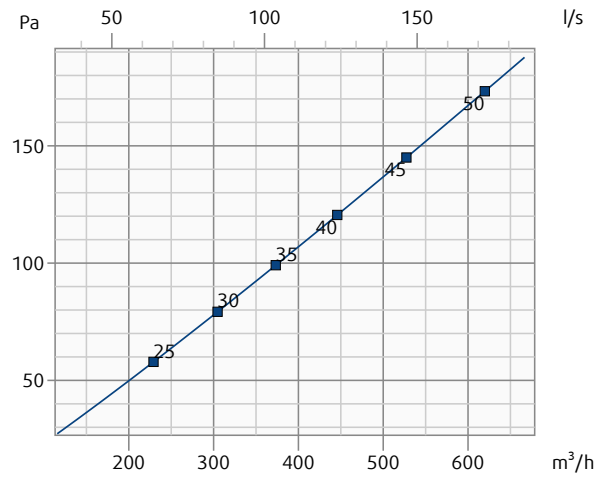

**CFC-A-H-535x535x80-160-SW + CAP-CFC-A-535x535-SW**    **CFC-A-H-557x557x80-200-SW + CAP-CFC-A-557x557-SW**

Throw length (terminal velocity 0.2 m/s)

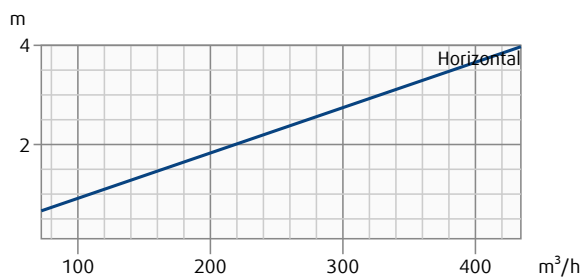

Throw length (terminal velocity 0.2 m/s)

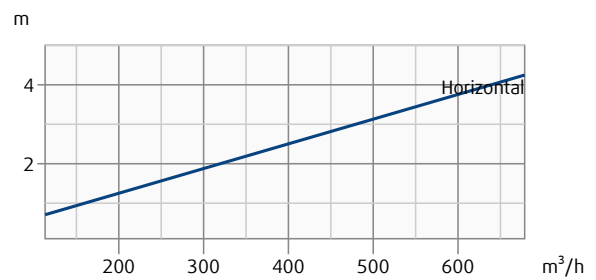

Pressure drop and radiated sound power level dependent on air flow volume

Throw length with terminal velocity 0,2 m/s dependent on air flow volume

**CFC-A-H-575x575x80-200-SW + CAP-CFC-A-575x575-SW**    **CFC-A-H-610x610x80-250-SW + CAP-CFC-A-610x610-SW**

Pressure drop & A-weighted sound power level in dB(A)

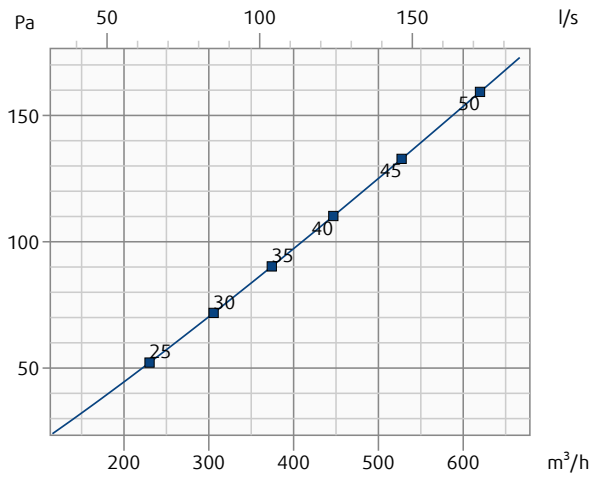

Pressure drop & A-weighted sound power level in dB(A)

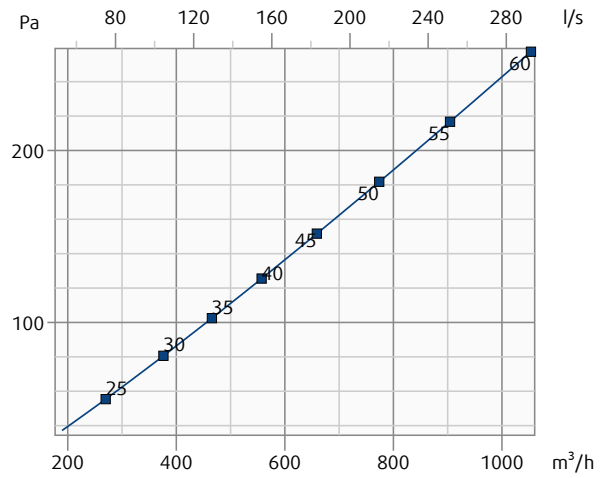

**CFC-A-H-575x575x80-200-SW + CAP-CFC-A-575x575-SW**    **CFC-A-H-610x610x80-250-SW + CAP-CFC-A-610x610-SW**

Throw length (terminal velocity 0.2 m/s)

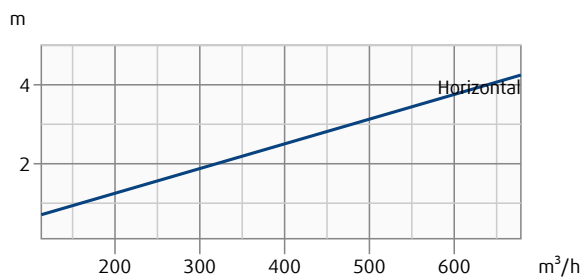

Throw length (terminal velocity 0.2 m/s)

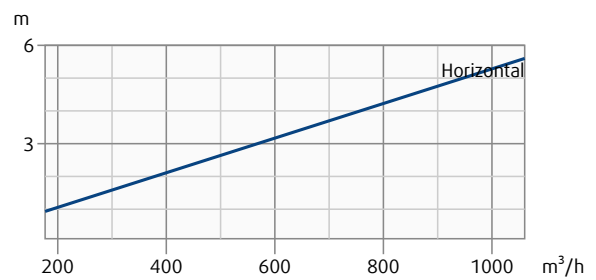

Pressure drop and radiated sound power level dependent on air flow volume

Throw length with terminal velocity 0,2 m/s dependent on air flow volume

**CFC-A-H-305x305x80-125-SW + VVKN-CFC-A-305x305-SW**

Pressure drop & A-weighted sound power level in dB(A)

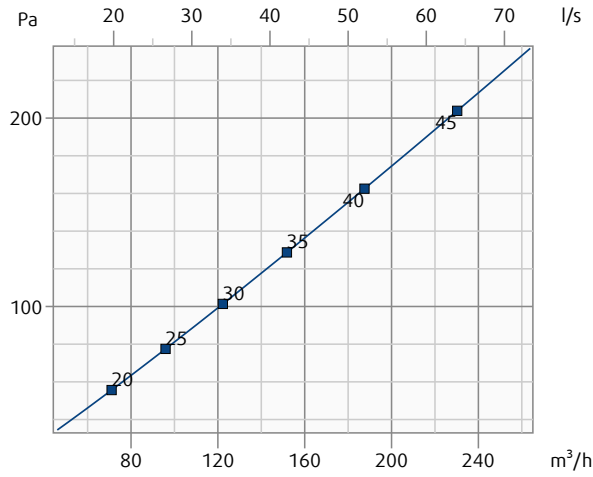

**CFC-A-H-457x457x80-160-SW + VVKN-CFC-A-457x457-SW**

Pressure drop & A-weighted sound power level in dB(A)

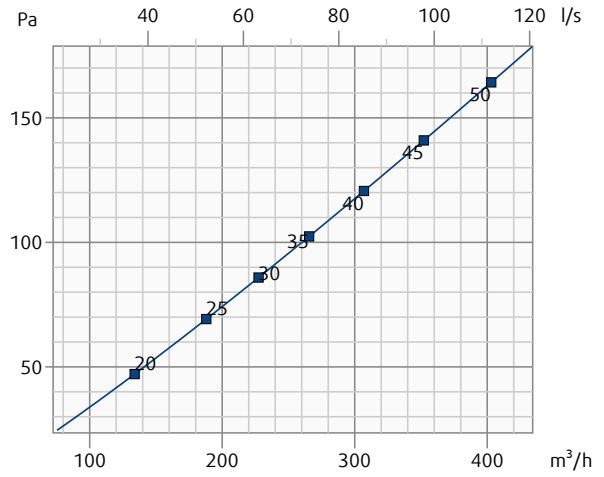

**CFC-A-H-305x305x80-125-SW + VVKN-CFC-A-305x305-SW**

Throw length (terminal velocity 0.2 m/s)

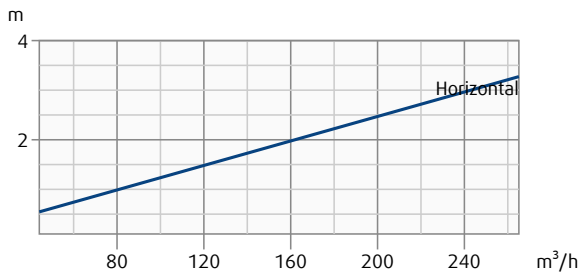

**CFC-A-H-457x457x80-160-SW + VVKN-CFC-A-457x457-SW**

Throw length (terminal velocity 0.2 m/s)

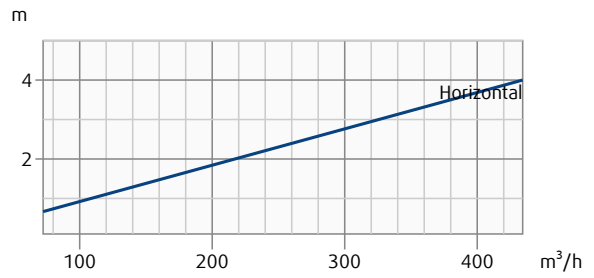



Pressure drop and radiated sound power level dependent on air flow volume

Throw length with terminal velocity 0,2 m/s dependent on air flow volume

**CFC-A-H-535x535x80-160-SW + VVKN-CFC-A-535x535-SW**

Pressure drop & A-weighted sound power level in dB(A)

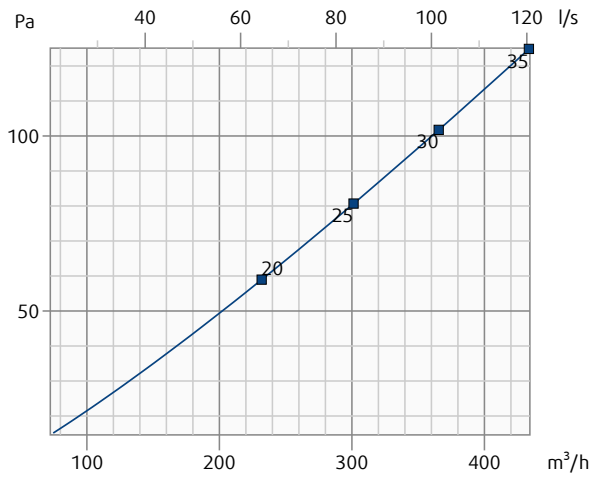

**CFC-A-H-557x557x80-200-SW + VVKN-CFC-A-557x557-SW**

Pressure drop & A-weighted sound power level in dB(A)

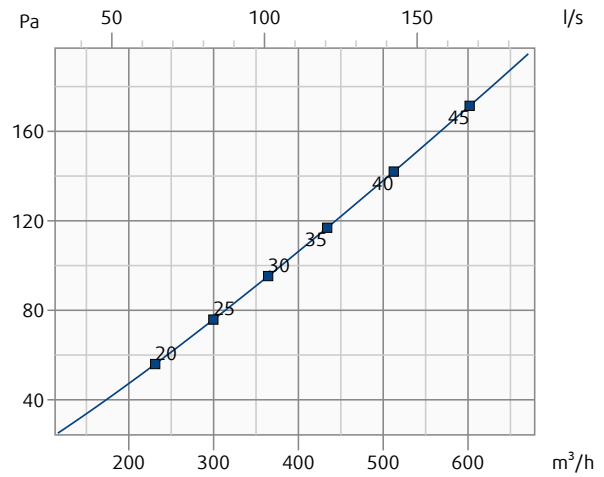

**CFC-A-H-535x535x80-160-SW + VVKN-CFC-A-535x535-SW**

Throw length (terminal velocity 0.2 m/s)

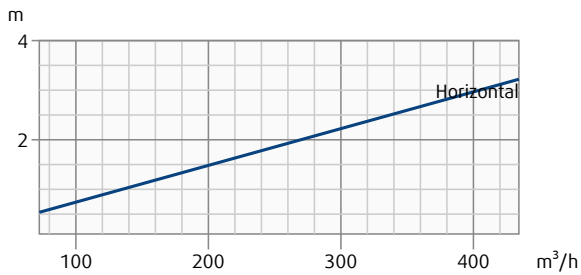

**CFC-A-H-557x557x80-200-SW + VVKN-CFC-A-557x557-SW**

Throw length (terminal velocity 0.2 m/s)

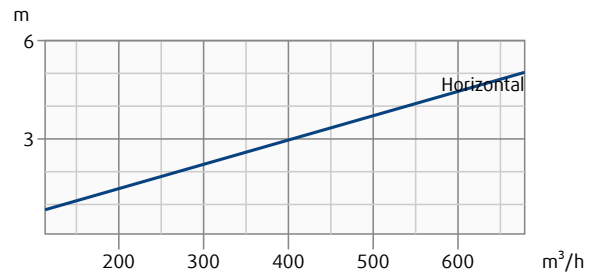

Pressure drop and radiated sound power level dependent on air flow volume

Throw length with terminal velocity 0,2 m/s dependent on air flow volume

**CFC-A-H-575x575x80-200-SW + VVKN-CFC-A-575x575-SW**

**CFC-A-H-610x610x80-250-SW + VVKN-CFC-A-610x610-SW**

Pressure drop & A-weighted sound power level in dB(A)

Pressure drop & A-weighted sound power level in dB(A)

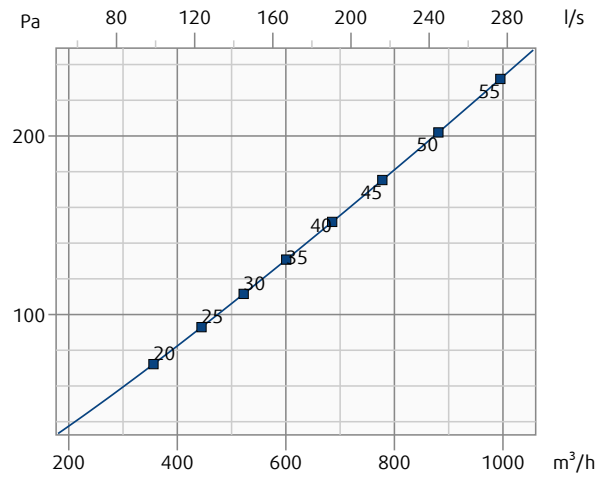
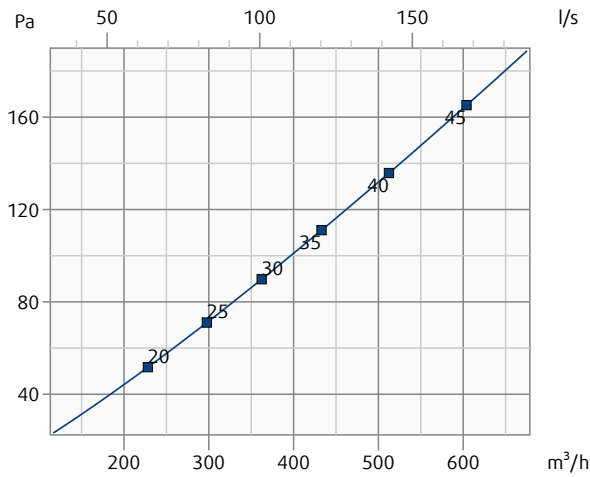

**CFC-A-H-575x575x80-200-SW + VVKN-CFC-A-575x575-SW**

**CFC-A-H-610x610x80-250-SW + VVKN-CFC-A-610x610-SW**

Throw length (terminal velocity 0.2 m/s)

Throw length (terminal velocity 0.2 m/s)

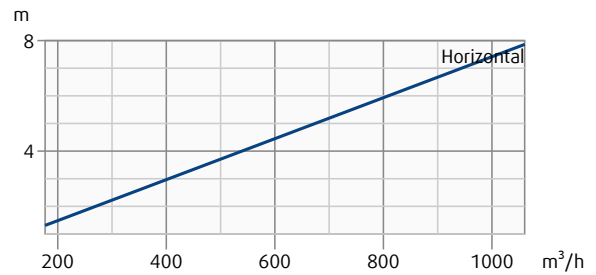
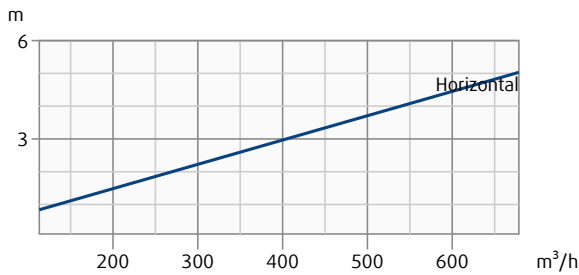

Pressure drop and radiated sound power level dependent on air flow volume

Throw length with terminal velocity 0,2 m/s dependent on air flow volume

**CFC-A-H-305x305x80-125-SW + VVKR-CFC-A-305x305-SW**

Pressure drop & A-weighted sound power level in dB(A)

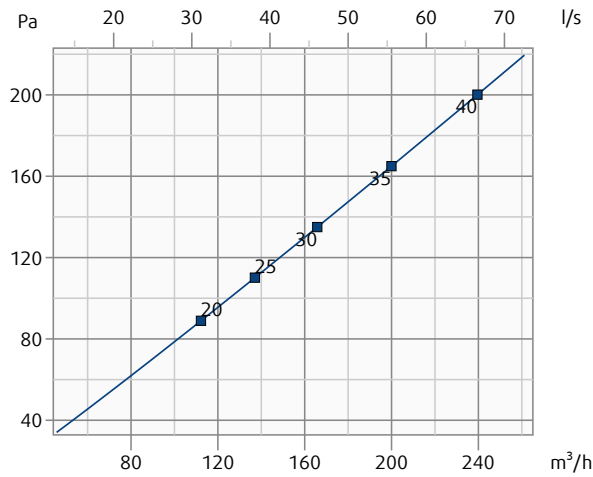

**CFC-A-H-457x457x80-160-SW + VVKR-CFC-A-457x457-SW**

Pressure drop & A-weighted sound power level in dB(A)

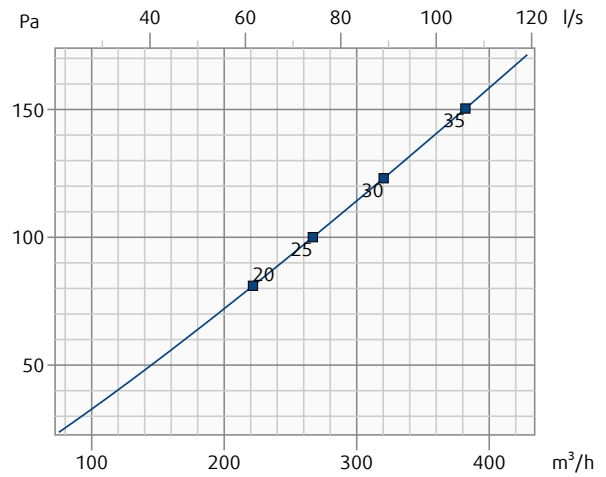

**CFC-A-H-305x305x80-125-SW + VVKR-CFC-A-305x305-SW**

Throw length (terminal velocity 0.2 m/s)

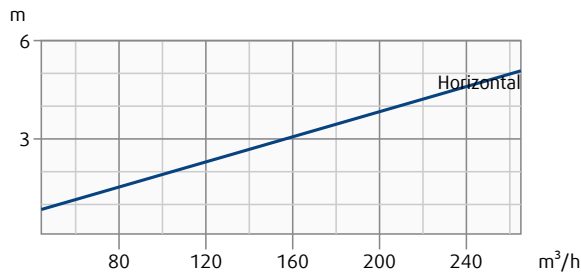

**CFC-A-H-457x457x80-160-SW + VVKR-CFC-A-457x457-SW**

Throw length (terminal velocity 0.2 m/s)

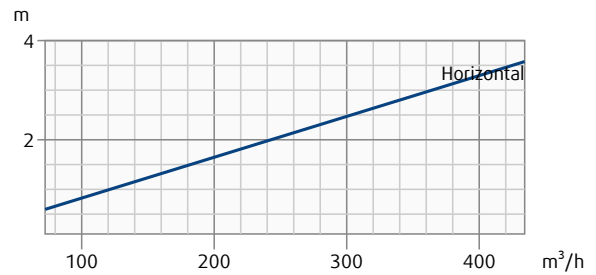

Pressure drop and radiated sound power level dependent on air flow volume

Throw length with terminal velocity 0,2 m/s dependent on air flow volume

**CFC-A-H-535x535x80-160-SW + VVKR-CFC-A-535x535-SW**

Pressure drop & A-weighted sound power level in dB(A)

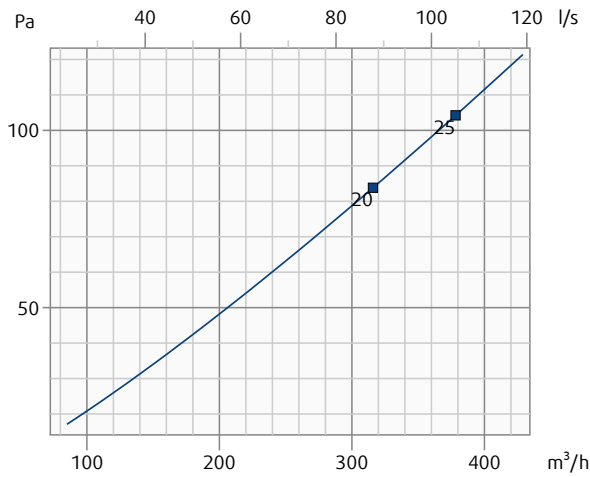

**CFC-A-H-557x557x80-200-SW + VVKR-CFC-A-557x557-SW**

Pressure drop & A-weighted sound power level in dB(A)

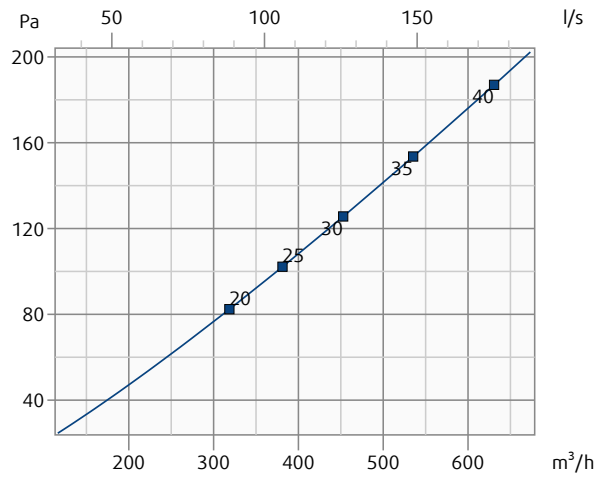

**CFC-A-H-535x535x80-160-SW + VVKR-CFC-A-535x535-SW**

Throw length (terminal velocity 0.2 m/s)

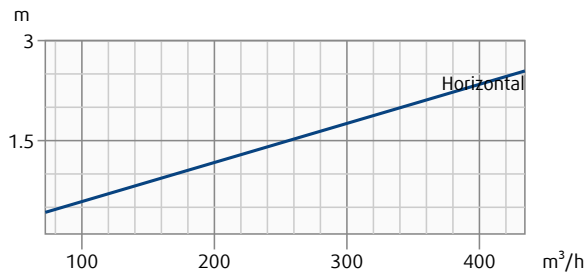

**CFC-A-H-557x557x80-200-SW + VVKR-CFC-A-557x557-SW**

Throw length (terminal velocity 0.2 m/s)

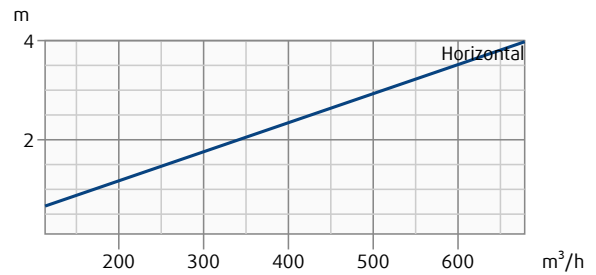

Pressure drop and radiated sound power level dependent on air flow volume

Throw length with terminal velocity 0,2 m/s dependent on air flow volume

**CFC-A-H-575x575x80-200-SW + VVKR-CFC-A-575x575-SW**

Pressure drop & A-weighted sound power level in dB(A)

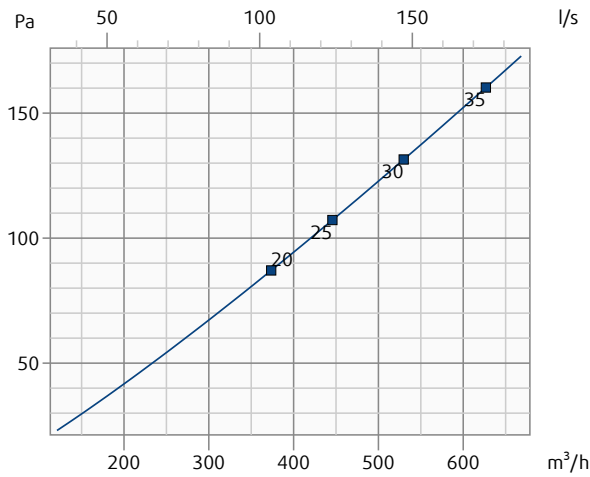

**CFC-A-H-610x610x80-250-SW + VVKR-CFC-A-610x610-SW**

Pressure drop & A-weighted sound power level in dB(A)

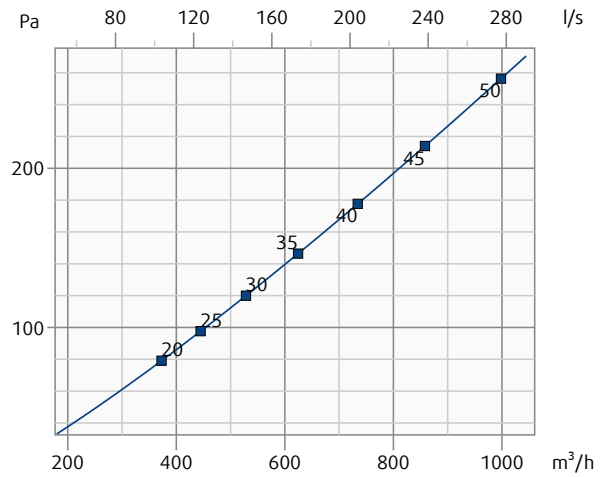

**CFC-A-H-575x575x80-200-SW + VVKR-CFC-A-575x575-SW**

Throw length (terminal velocity 0.2 m/s)

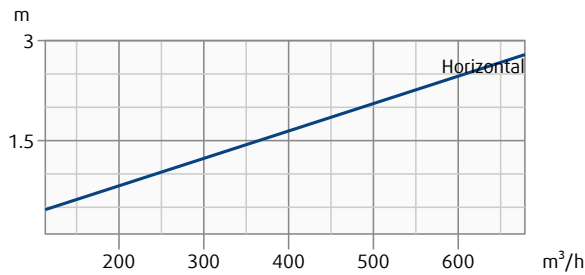

**CFC-A-H-610x610x80-250-SW + VVKR-CFC-A-610x610-SW**

Throw length (terminal velocity 0.2 m/s)

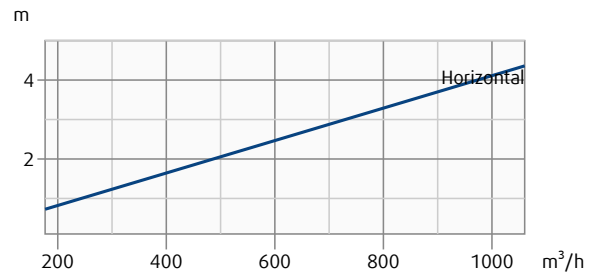

# Installation



4 ×

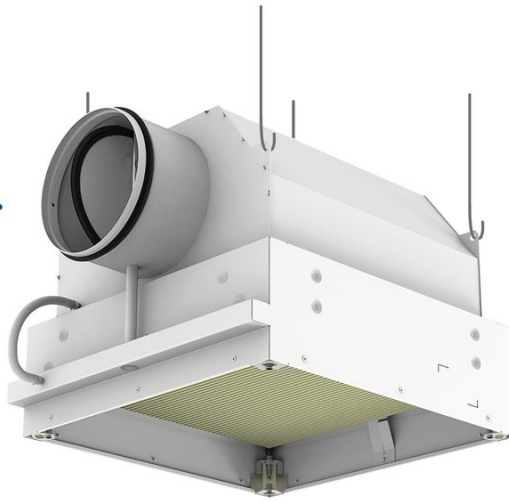

a)

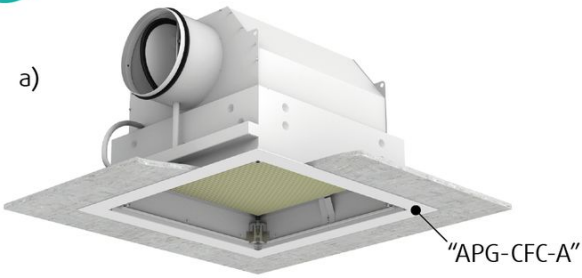

b)

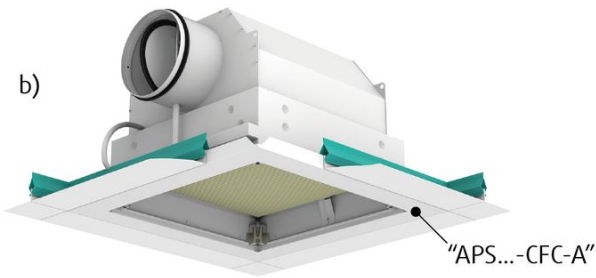

c)

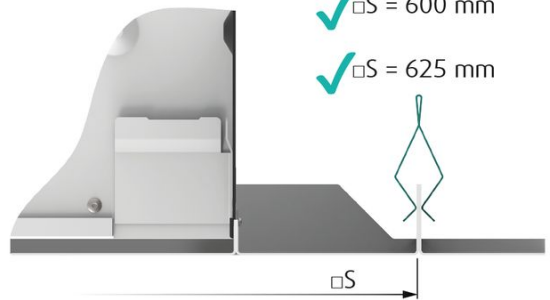
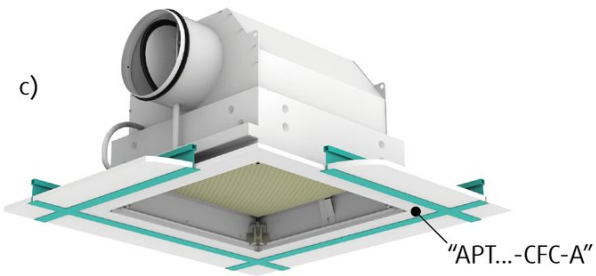

✓ □S = 600 mm

✓ □S = 625 mm

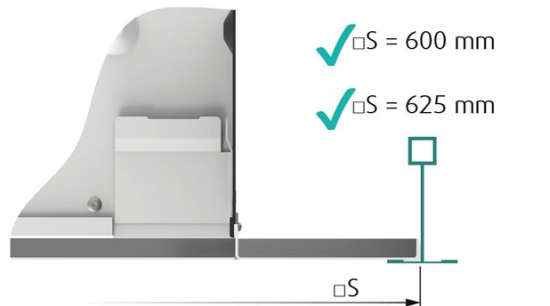

✓ □S = 600 mm

✓ □S = 625 mm



"CFC-A" + "APS...CFC-A" / "APT...CFC-A" / "APG-CFC-A"

1.

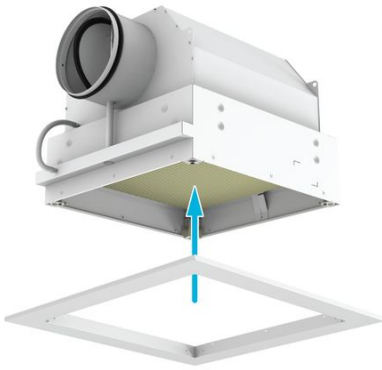

2.

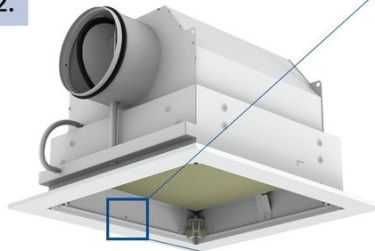



"CFC-A" + "CFC-HF"

1.

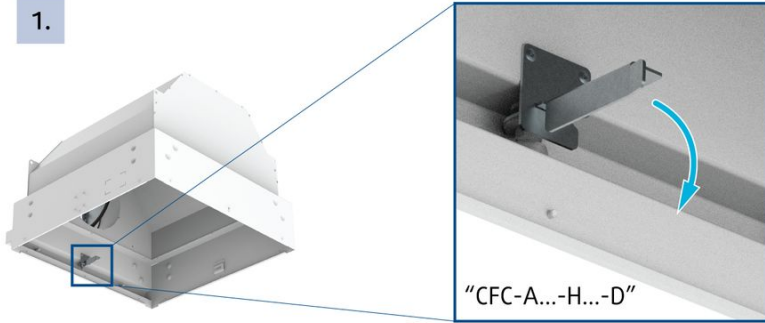

2.

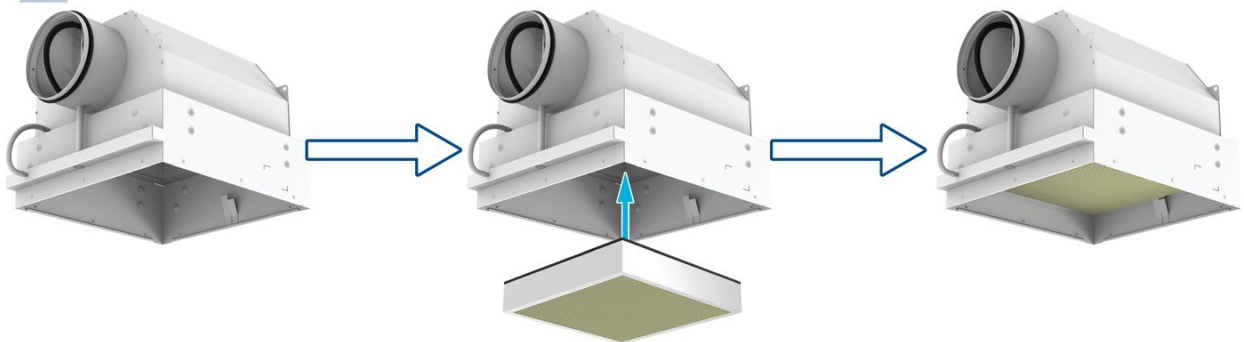

3.

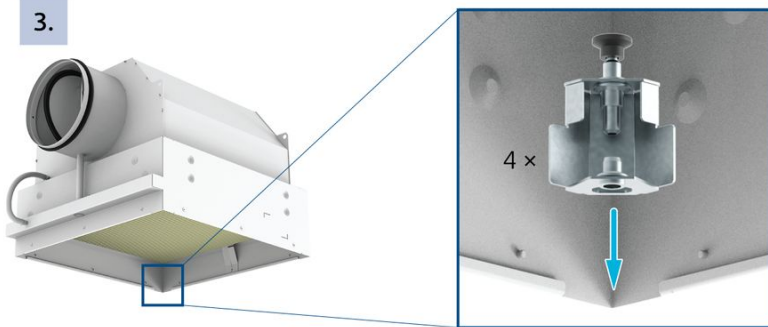

4.

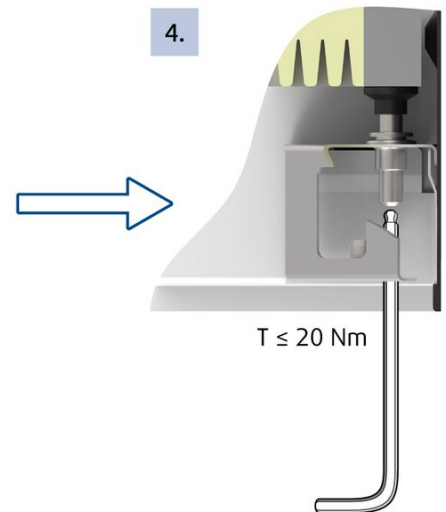

5.

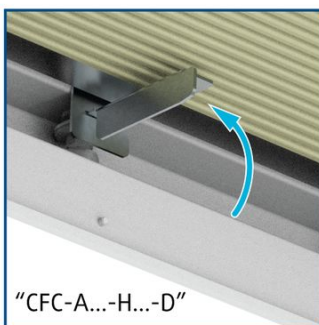



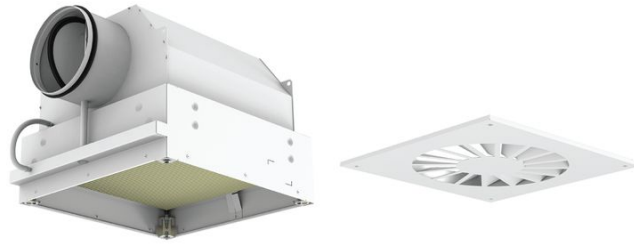

"CFC-A" + "VVKN-CFC-A" (/ "PP-CFC-A" / "CAP-CFC-A" / "ADQ-CFC-A" / "VVKR-CFC-A")

6.

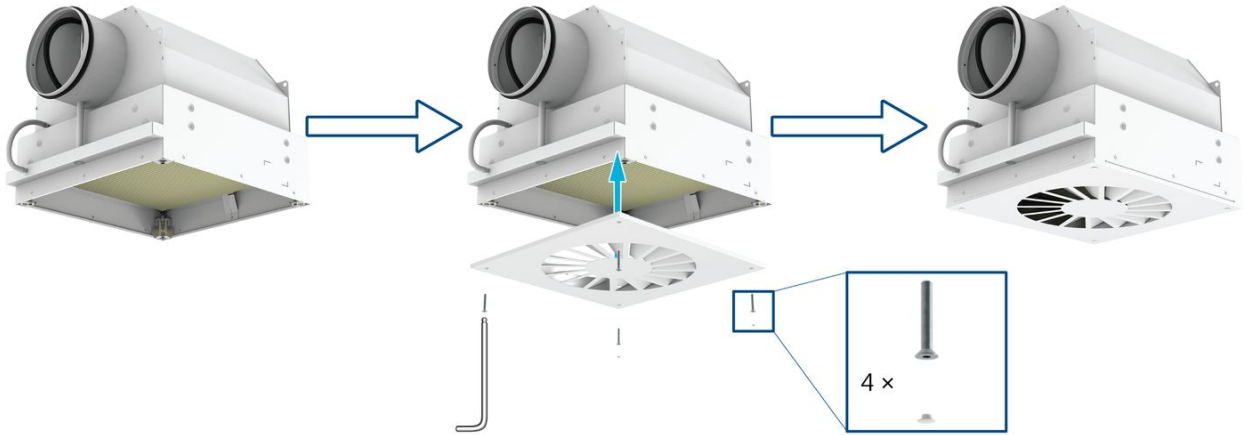

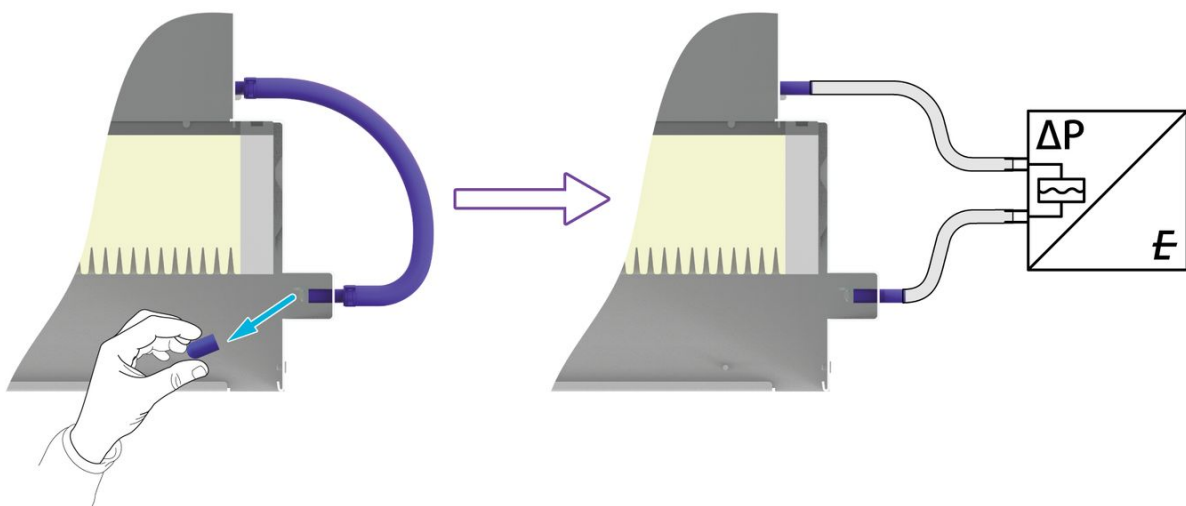
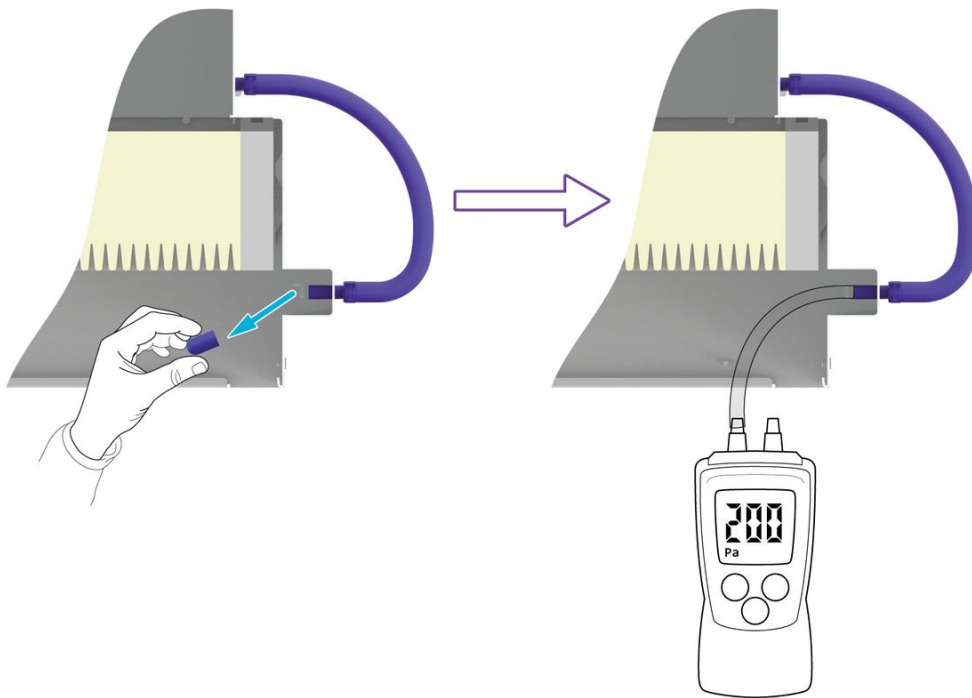
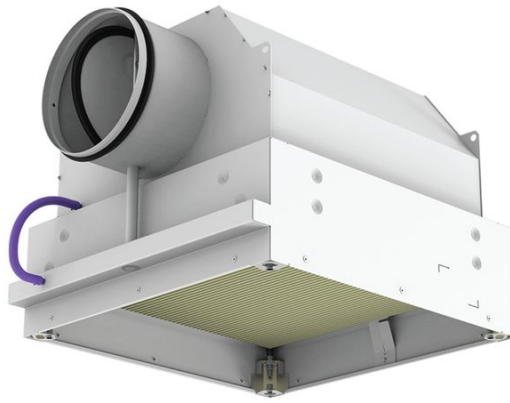
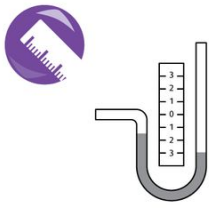



# Maintenance

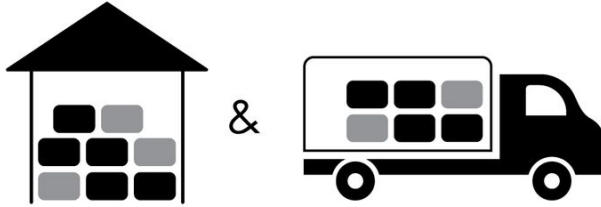

# Transport, Storage and Operation



 °C -20°C ... +50°C

 % ≤ 95%



 °C 0°C ... +50°C

 % ≤ 95%

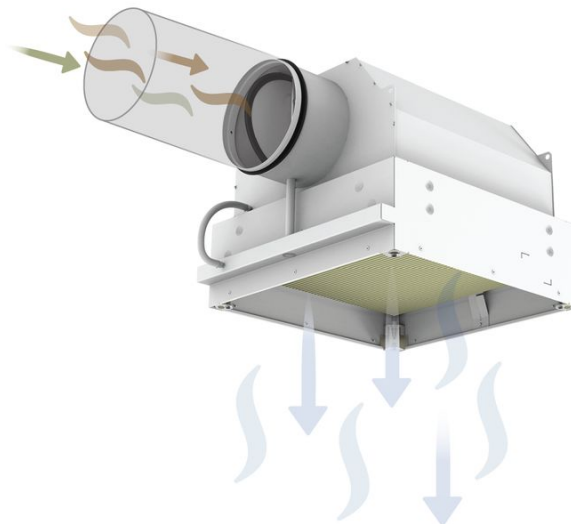

# Supplement

Any deviations from the technical specifications contained on our website and the terms should be discussed with the manufacturer. We reserve the right to make any changes to the product without prior notice, provided that these changes do not affect the quality of the product and the required parameters. Current information on all products is available on [design.systemair.com](https://design.systemair.com).

