

NOVA-EF

Filtrirna rešetka za odvod zraka

Uporabniški priročnik



Kazalo vsebine

Opis3
Dimenzije4
Koda za naročanje5
Tehnični parametri6
Namestitev19
Transport, skladiščenje in uporaba22
Dodatek23

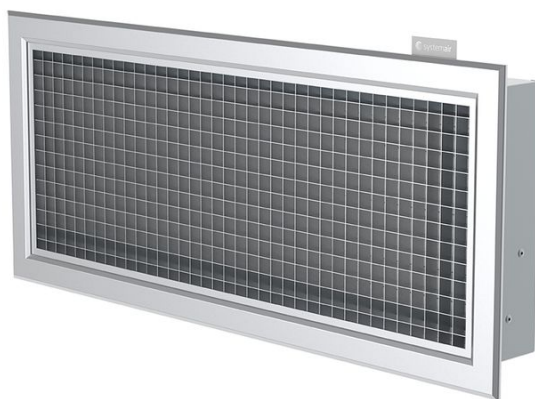

Opis

NOVA-EF je prezračevalna rešetka s filtrom za vgradnjo v stene ali stropne v pisarnah, stanovanjskih prostorih ali hotelih. Namenjena je odvajanju zraka predvsem v sistemih na obtočni zrak z ventilatorskimi konvektorji.

Poudarki

- Nizek tlačni padec in visoka zmogljivost pretoka zraka
- Trajnost delovanja in enostavnost vgradnje v stenah in stropih v vseh razpoložljivih velikostih
- Za hiter in enostaven dostop do vložka filtra ni potrebno orodje za čiščenje in vzdrževanje

Konstrukcija

NOVA-EF je sestavljena iz dveh glavnih delov. Stenski ali stropni montažni okvir iz pocinkanega jekla s snemljivim mrežnim zaslonom in vložkom filtra. Snemljiva sprednja rešetka z eloksiranim aluminijastim okvirjem in fiksna kovinska rešetka s prosto površino več kot 90%. Filter iz razreda „65% grobost“ je dostopen brez orodja. Za to je mogoče prednjo rešetko, ki je v okvir pritrjena z vzmetnimi sponkami, enostavno odpreti ali odstraniti.

Dimenzije

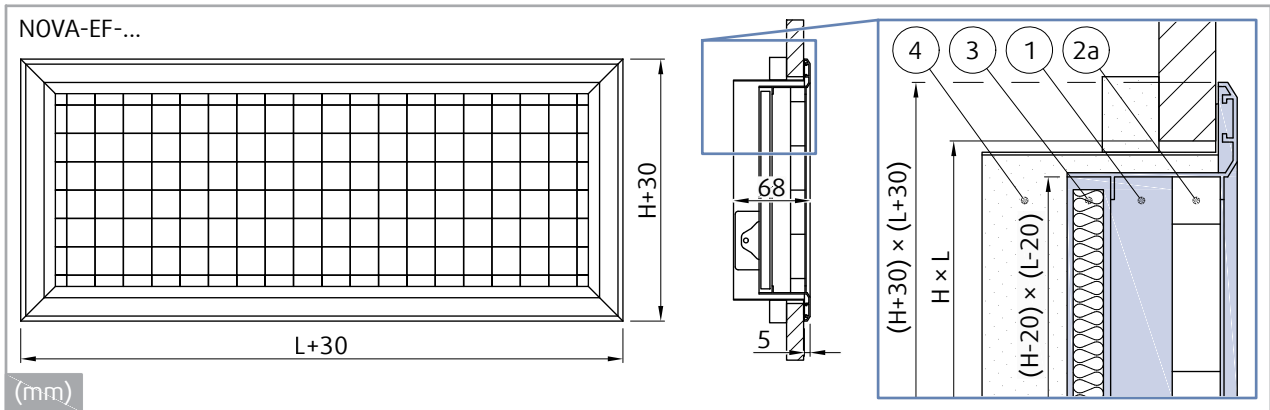

Legenda

- 1 Okvir rešetke
- 2a Rešetka
- 2b Odprtina
- 2c Lamelle
- 3 Filter
- 4 Pritrdilni okvir

		NOVA-EF-...															
m (kg)		L (mm)															
		200	225	300	325	400	425	500	525	600	625	800	825	1000	1025	1200	1225
H (mm)	100	0,3	-	0,4	-	0,5	-	0,6	-	0,7	-	0,9	-	1,1	-	1,3	-
	125	-	0,4	-	0,6	-	0,8	-	0,9	-	1,0	-	-	-	1,3	-	1,5
	150	0,4	-	0,7	-	0,8	-	1,0	-	1,1	-	1,1	-	1,7	-	1,8	-
	200	0,5	-	0,9	-	1,1	-	1,3	-	1,5	-	1,9	-	2,1	-	2,2	-
	225	-	0,6	-	0,9	-	1,3	-	1,5	-	1,6	-	1,8	-	2,3	-	2,5
	300	-	-	1,1	-	1,4	-	1,6	-	1,8	-	2,2	-	2,7	-	2,8	-
	325	-	-	-	1,3	-	1,5	-	1,7	-	2,0	-	2,4	-	2,9	-	3,1
	400	-	-	-	-	1,6	-	1,9	-	2,2	-	2,6	-	3,1	-	3,2	-
	425	-	-	-	-	-	1,7	-	2,0	-	2,3	-	2,8	-	3,3	-	3,7
	500	-	-	-	-	-	-	2,2	-	2,5	-	2,8	-	3,8	-	4,0	-
	525	-	-	-	-	-	-	-	2,3	-	2,6	-	3,1	-	4,1	-	4,2
	600	-	-	-	-	-	-	-	-	-	-	-	-	-	4,3	-	4,3

Koda za naročanje

Dolžina (mm) × Višina (mm)

Razpoložljive kombinacije dimenzij glejte v tabeli dimenzij.

Površinska obdelava

SW Signalno bela (RAL9003, sijaj 30%)

AN Barva eloksiranega aluminija

Primer kode za naročanje

NOVA-EF-500x200-SW

Rešetka NOVA-EF velikosti 500 mm × 200 mm v signalno beli barvi (RAL9003).

Tehnični parametri

Padec tlaka in raven sevane zvočne moči sta odvisna od količine pretoka zraka.

NOVA-EF-200x100-AN

Padec tlaka in A-ponderirana raven zvočne moči v dB(A)

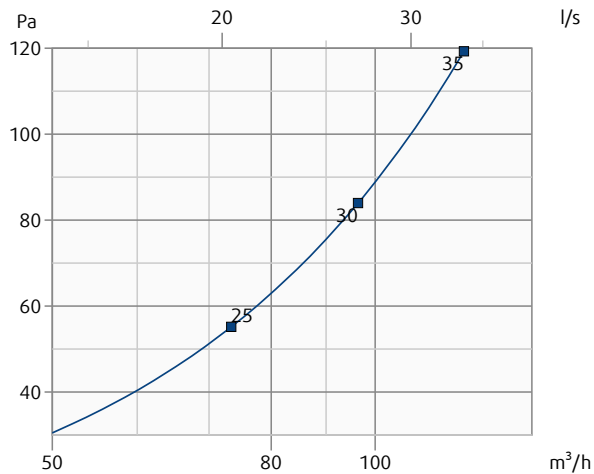

NOVA-EF-200x150-AN

Padec tlaka in A-ponderirana raven zvočne moči v dB(A)

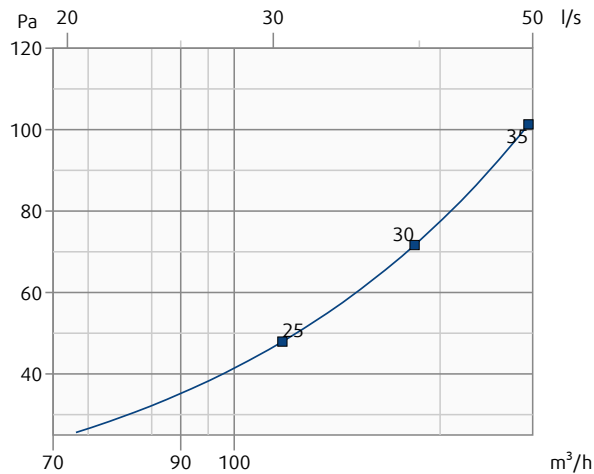

NOVA-EF-200x200-AN

Padec tlaka in A-ponderirana raven zvočne moči v dB(A)

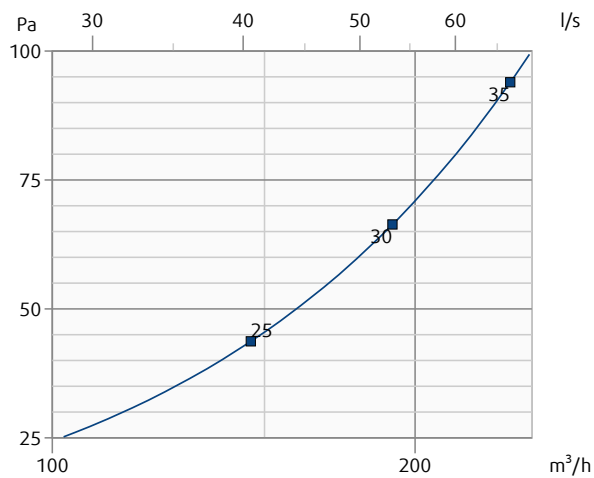

NOVA-EF-225x125-AN

Padec tlaka in A-ponderirana raven zvočne moči v dB(A)

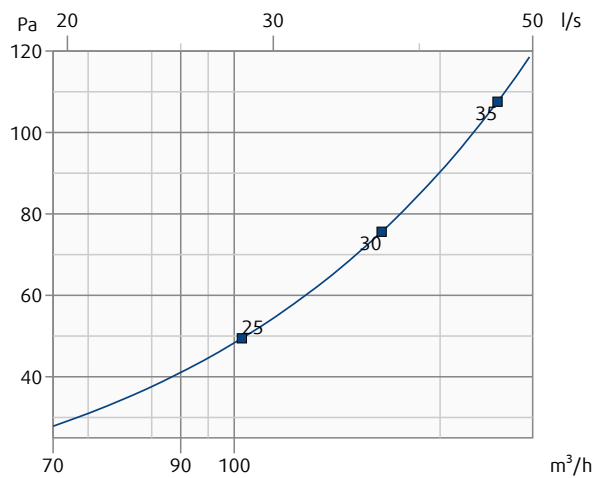

Padec tlaka in raven sevane zvočne moči sta odvisna od količine pretoka zraka.

NOVA-EF-225x225-AN

Padec tlaka in A-ponderirana raven zvočne moči v dB(A)

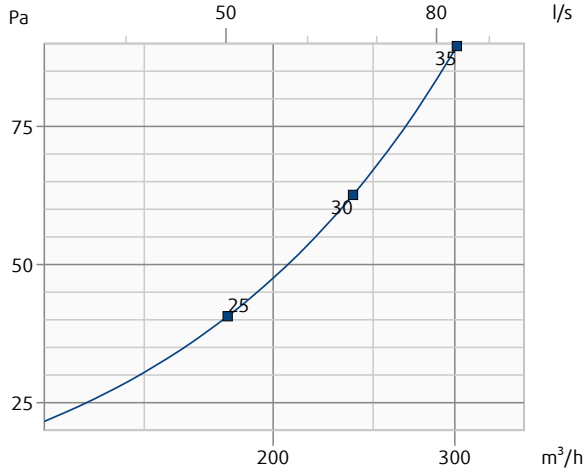

NOVA-EF-300x100-AN

Padec tlaka in A-ponderirana raven zvočne moči v dB(A)

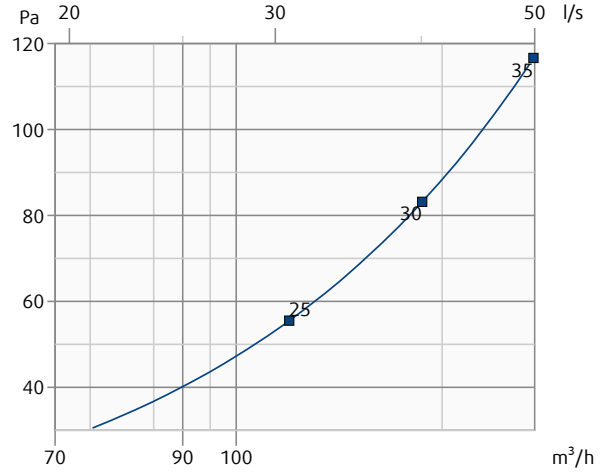

NOVA-EF-300x150-AN

Padec tlaka in A-ponderirana raven zvočne moči v dB(A)

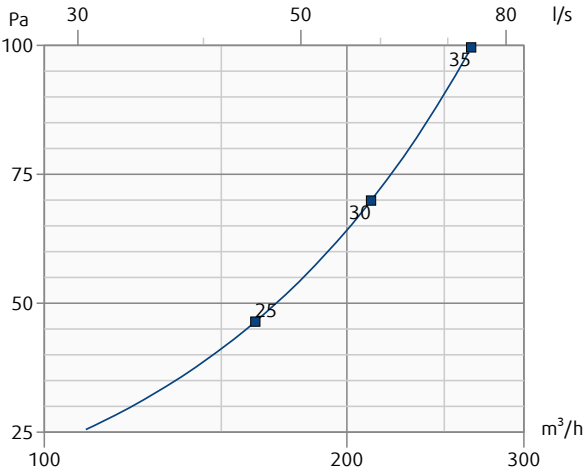

NOVA-EF-300x200-AN

Padec tlaka in A-ponderirana raven zvočne moči v dB(A)

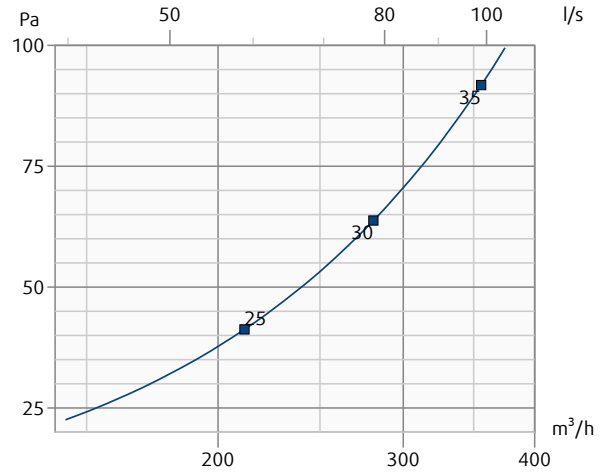

NOVA-EF-300x300-AN

Padec tlaka in A-ponderirana raven zvočne moči v dB(A)

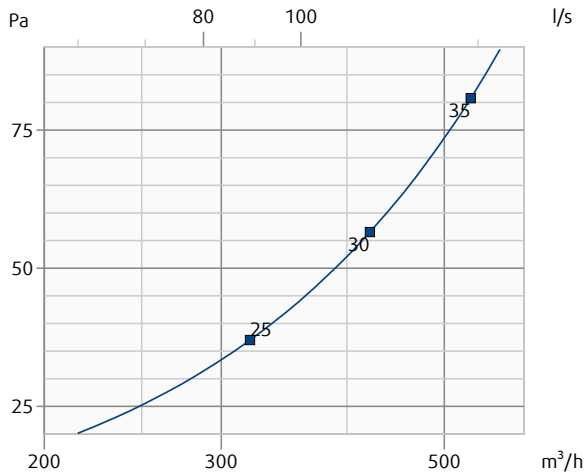

NOVA-EF-325x125-AN

Padec tlaka in A-ponderirana raven zvočne moči v dB(A)

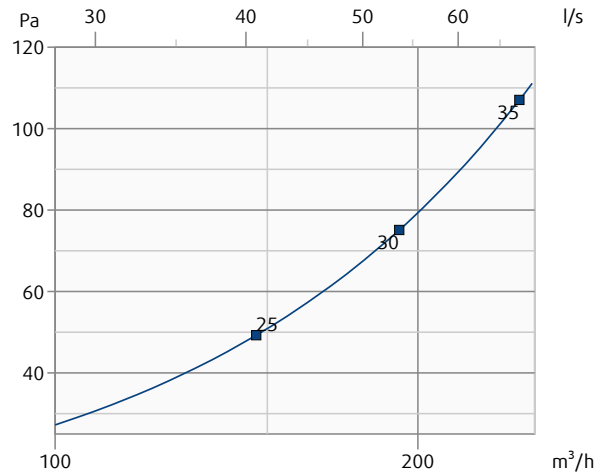

Padec tlaka in raven sevane zvočne moči sta odvisna od količine pretoka zraka.

NOVA-EF-325x225-AN

Padec tlaka in A-ponderirana raven zvočne moči v dB(A)

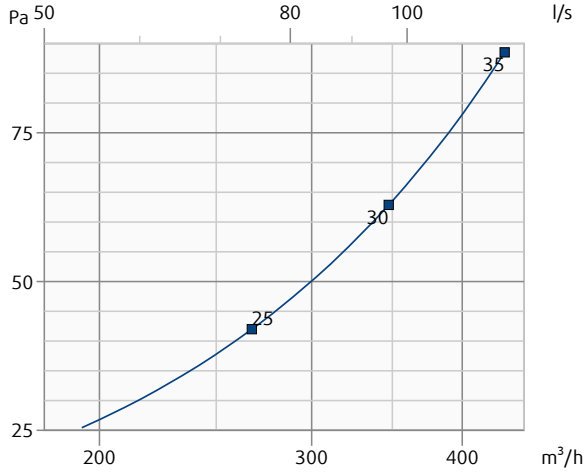

NOVA-EF-325x325-AN

Padec tlaka in A-ponderirana raven zvočne moči v dB(A)

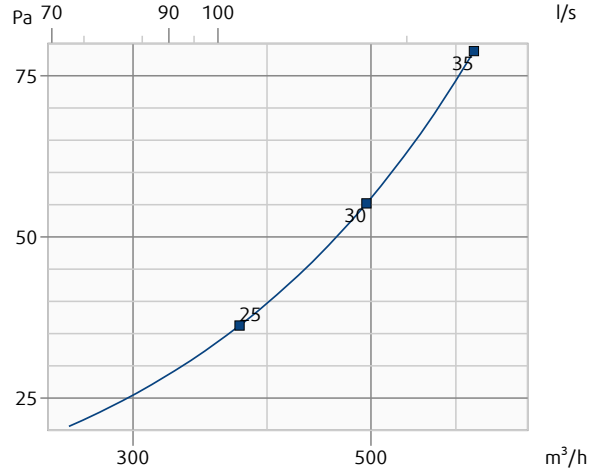

NOVA-EF-400x100-AN

Padec tlaka in A-ponderirana raven zvočne moči v dB(A)

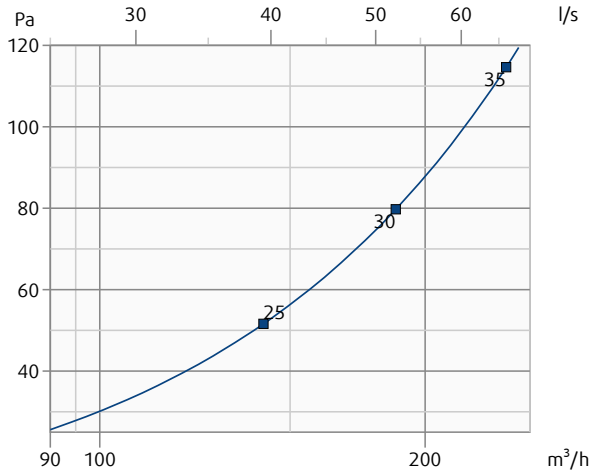

NOVA-EF-400x150-AN

Padec tlaka in A-ponderirana raven zvočne moči v dB(A)

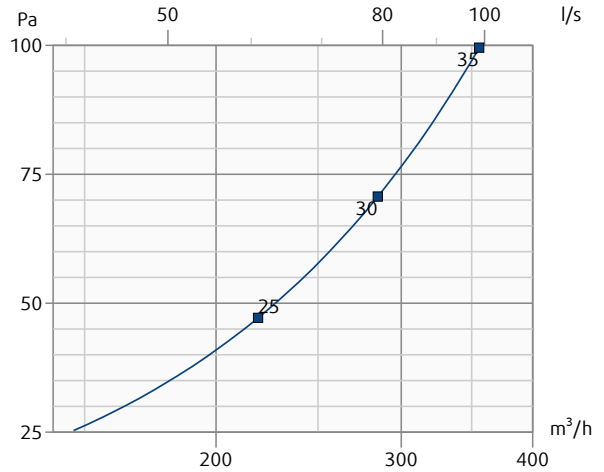

NOVA-EF-400x200-AN

Padec tlaka in A-ponderirana raven zvočne moči v dB(A)

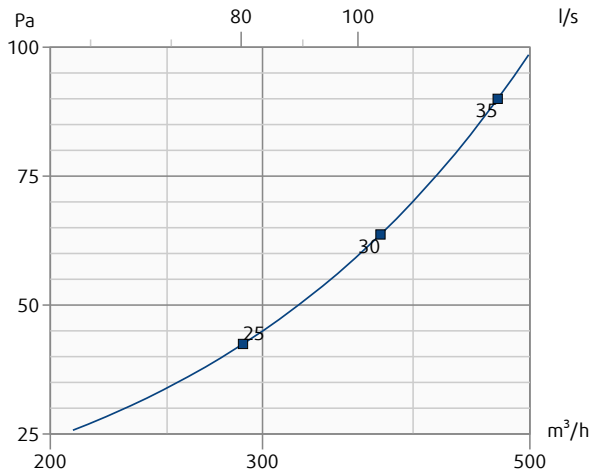

NOVA-EF-400x300-AN

Padec tlaka in A-ponderirana raven zvočne moči v dB(A)

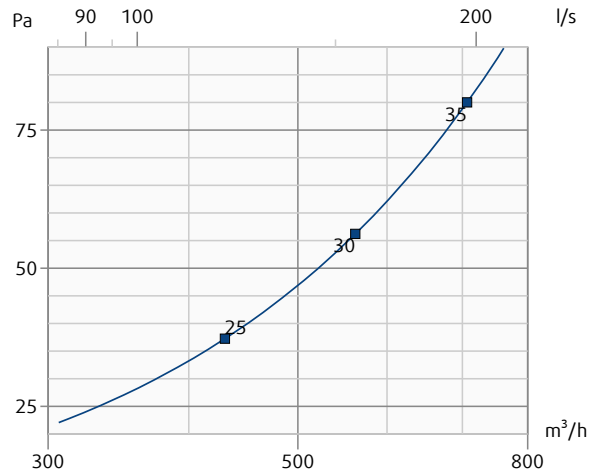

Padec tlaka in raven sevane zvočne moči sta odvisna od količine pretoka zraka.

NOVA-EF-400x400-AN

Padec tlaka in A-ponderirana raven zvočne moči v dB(A)

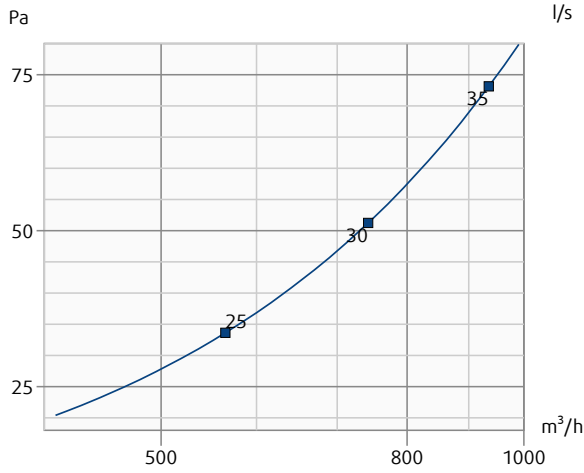

NOVA-EF-425x125-AN

Padec tlaka in A-ponderirana raven zvočne moči v dB(A)

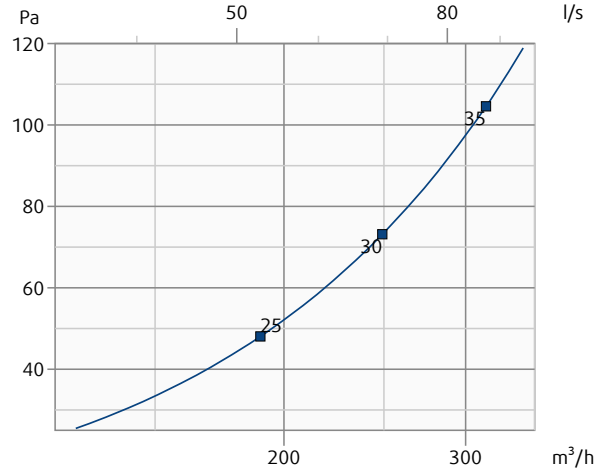

NOVA-EF-425x225-AN

Padec tlaka in A-ponderirana raven zvočne moči v dB(A)

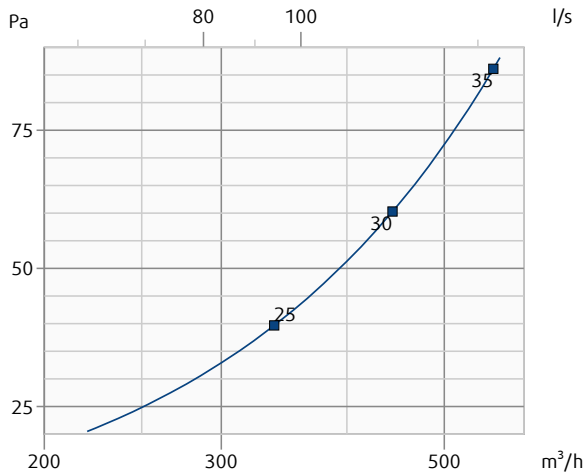

NOVA-EF-425x325-AN

Padec tlaka in A-ponderirana raven zvočne moči v dB(A)

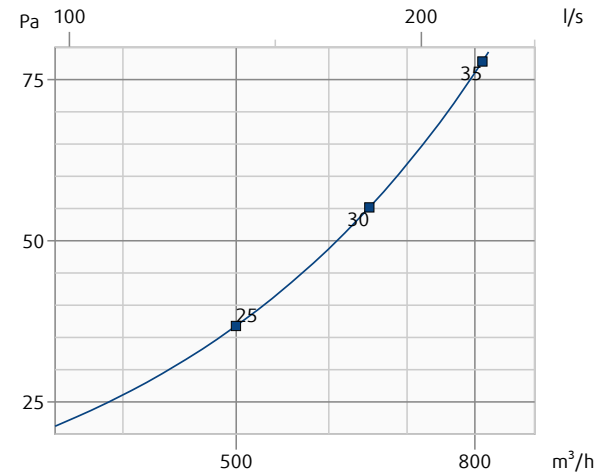

NOVA-EF-425x425-AN

Padec tlaka in A-ponderirana raven zvočne moči v dB(A)

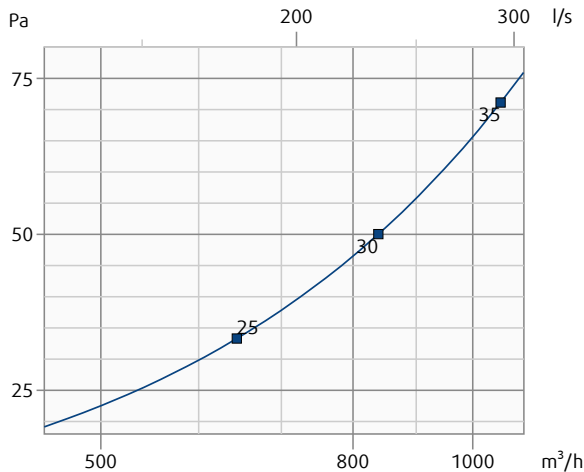

NOVA-EF-500x100-AN

Padec tlaka in A-ponderirana raven zvočne moči v dB(A)

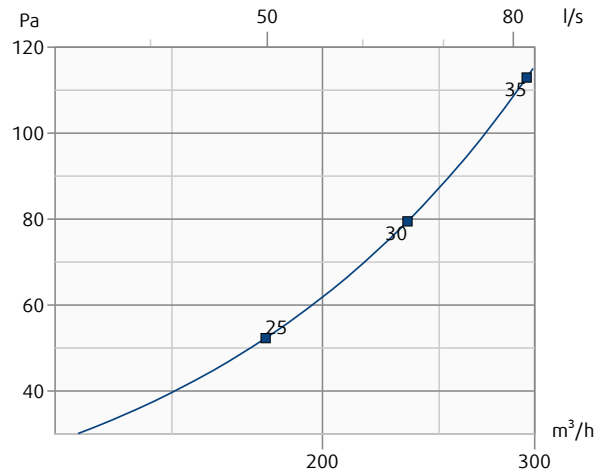

Padeč tlaka in raven sevane zvočne moči sta odvisna od količine pretoka zraka.

NOVA-EF-500x150-AN

Padeč tlaka in A-ponderirana raven zvočne moči v dB(A)

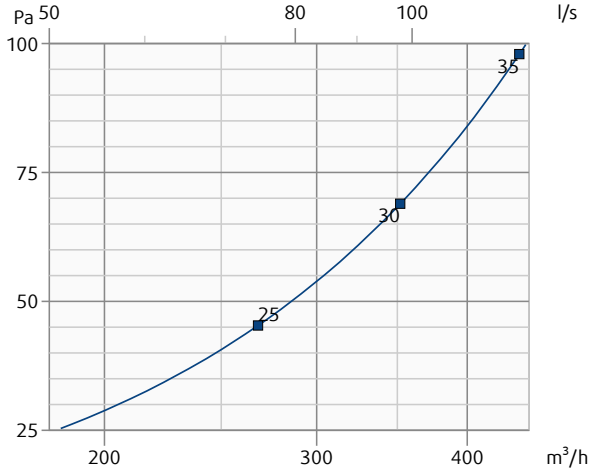

NOVA-EF-500x200-AN

Padeč tlaka in A-ponderirana raven zvočne moči v dB(A)

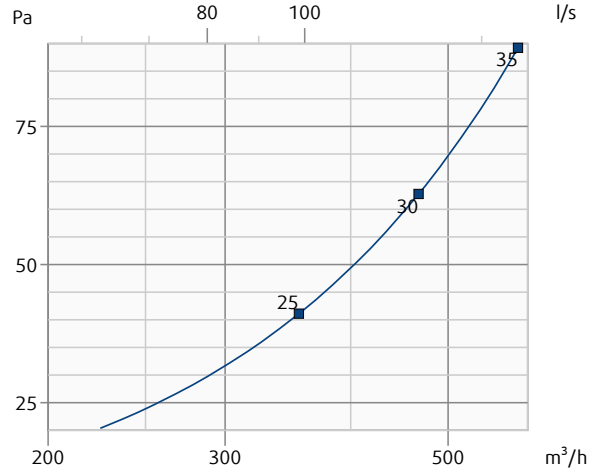

NOVA-EF-500x300-AN

Padeč tlaka in A-ponderirana raven zvočne moči v dB(A)

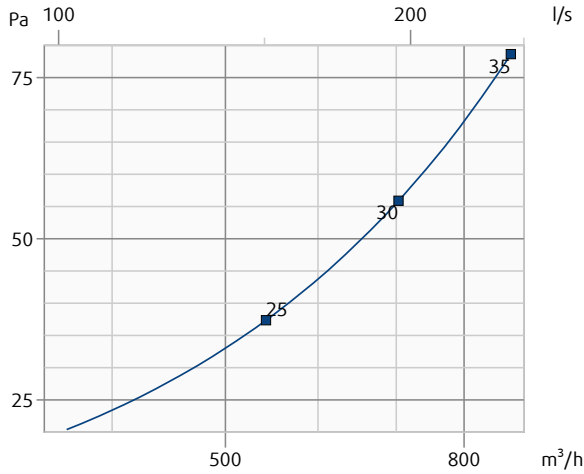

NOVA-EF-500x400-AN

Padeč tlaka in A-ponderirana raven zvočne moči v dB(A)

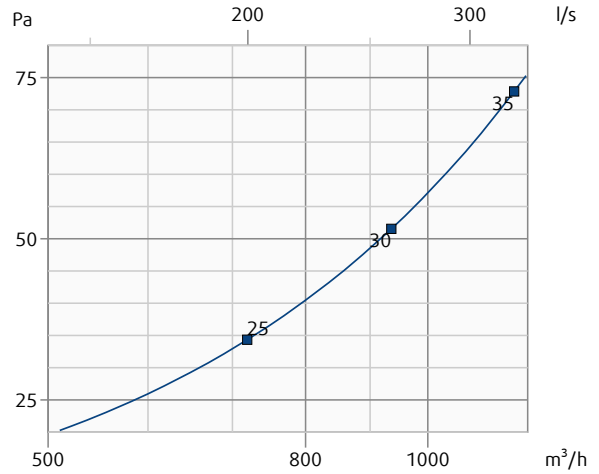

NOVA-EF-500x500-AN

Padeč tlaka in A-ponderirana raven zvočne moči v dB(A)

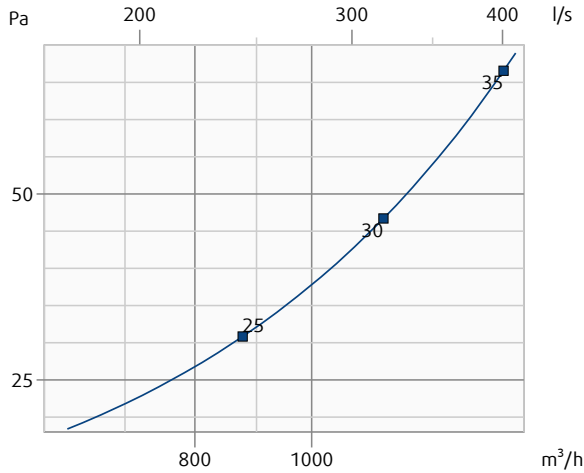

NOVA-EF-525x125-AN

Padeč tlaka in A-ponderirana raven zvočne moči v dB(A)

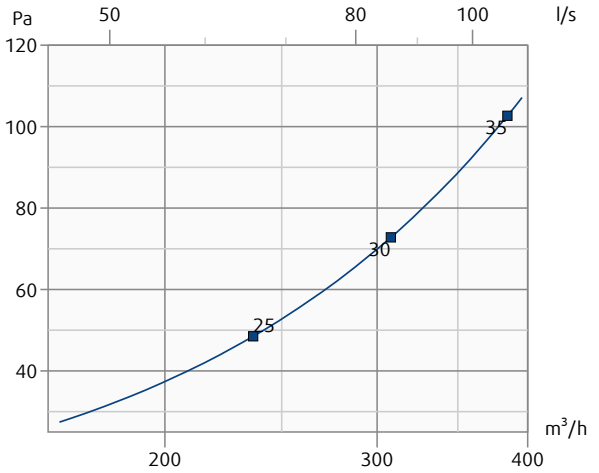

Padec tlaka in raven sevane zvočne moči sta odvisna od količine pretoka zraka.

NOVA-EF-525x225-AN

Padec tlaka in A-ponderirana raven zvočne moči v dB(A)

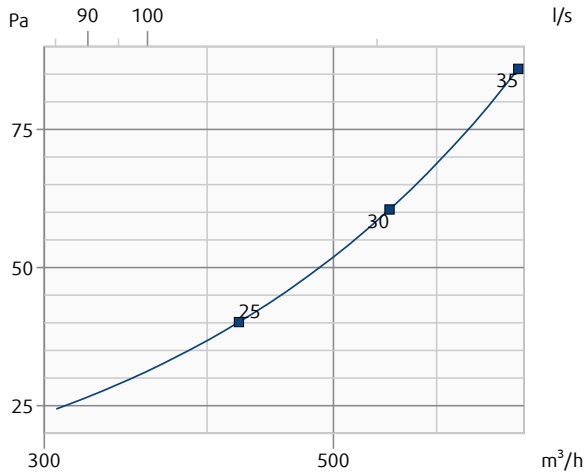

NOVA-EF-525x325-AN

Padec tlaka in A-ponderirana raven zvočne moči v dB(A)

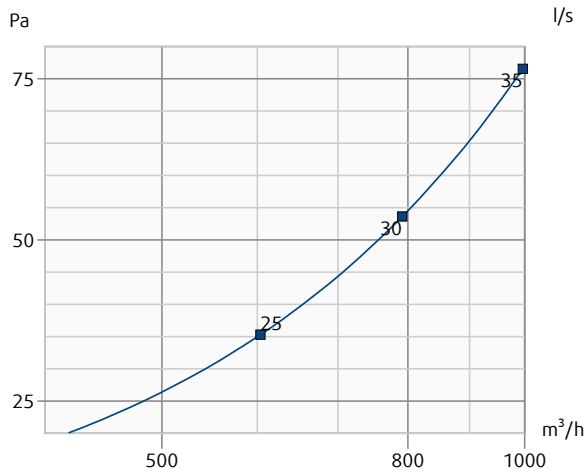

NOVA-EF-525x425-AN

Padec tlaka in A-ponderirana raven zvočne moči v dB(A)

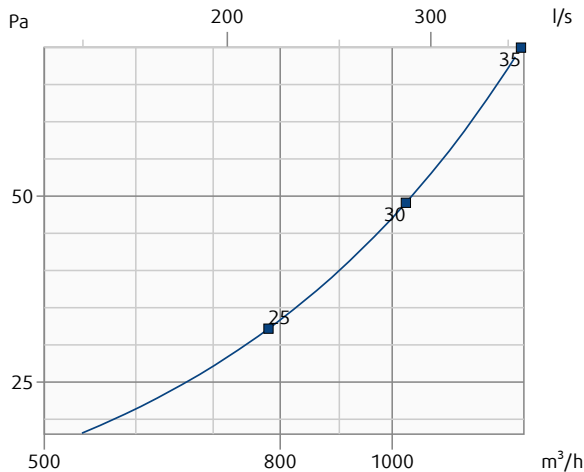

NOVA-EF-525x525-AN

Padec tlaka in A-ponderirana raven zvočne moči v dB(A)

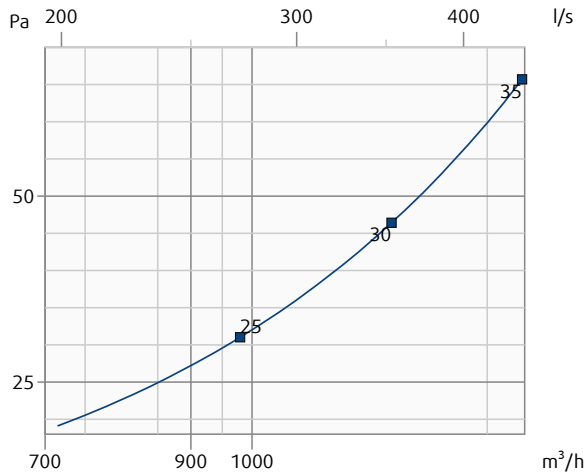

NOVA-EF-600x100-AN

Padec tlaka in A-ponderirana raven zvočne moči v dB(A)

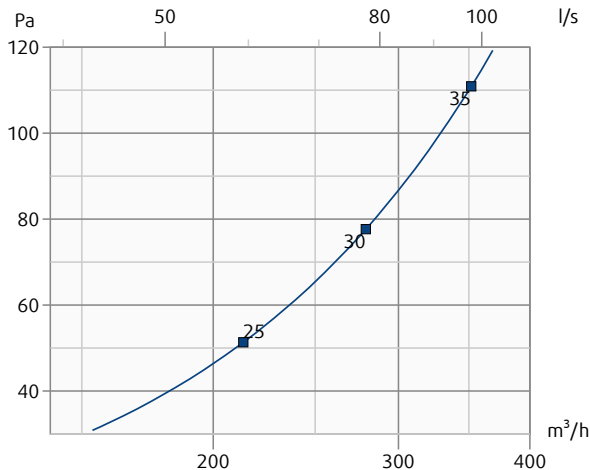

NOVA-EF-600x150-AN

Padec tlaka in A-ponderirana raven zvočne moči v dB(A)

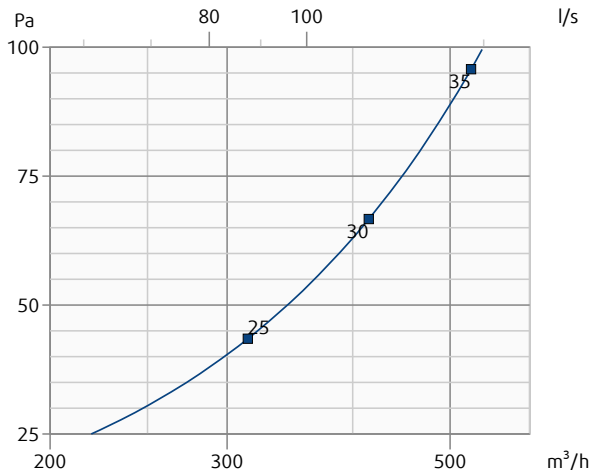

Padec tlaka in raven sevane zvočne moči sta odvisna od količine pretoka zraka.

NOVA-EF-600x200-AN

Padec tlaka in A-ponderirana raven zvočne moči v dB(A)

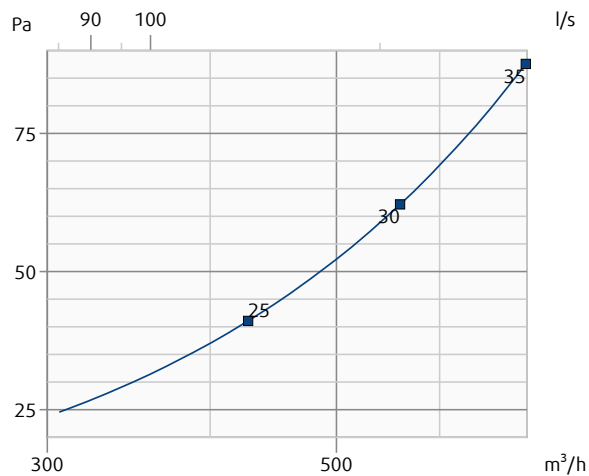

NOVA-EF-600x300-AN

Padec tlaka in A-ponderirana raven zvočne moči v dB(A)

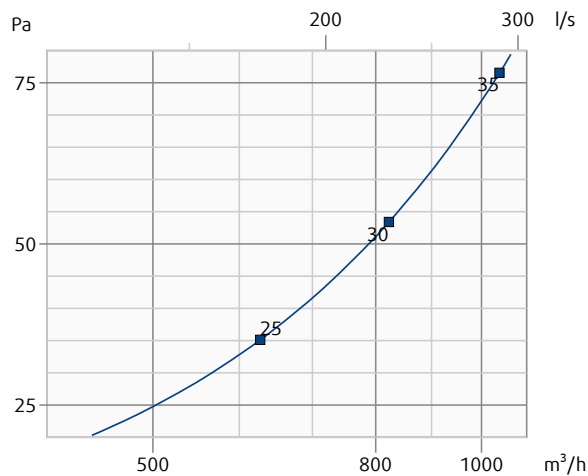

NOVA-EF-600x400-AN

Padec tlaka in A-ponderirana raven zvočne moči v dB(A)

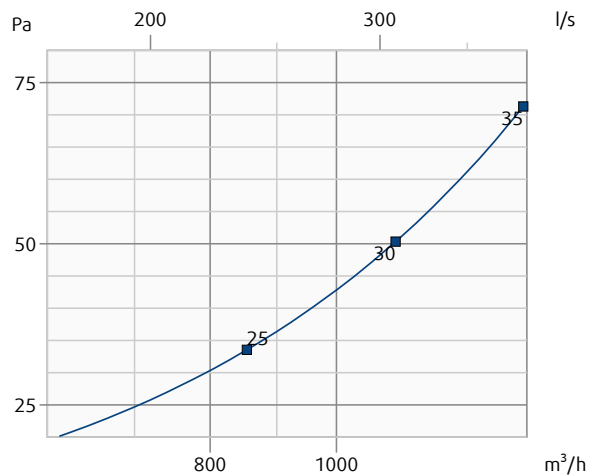

NOVA-EF-600x500-AN

Padec tlaka in A-ponderirana raven zvočne moči v dB(A)

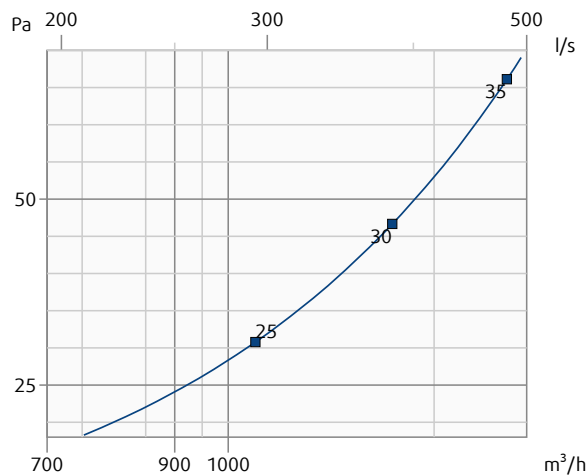

NOVA-EF-625x125-AN

Padec tlaka in A-ponderirana raven zvočne moči v dB(A)

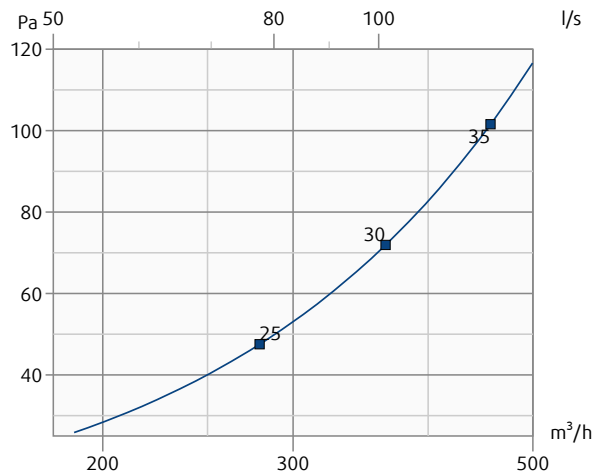

NOVA-EF-625x225-AN

Padec tlaka in A-ponderirana raven zvočne moči v dB(A)

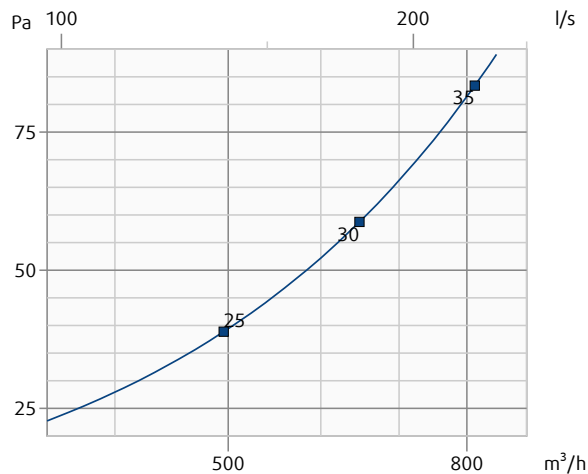

Padec tlaka in raven sevane zvočne moči sta odvisna od količine pretoka zraka.

NOVA-EF-625x325-AN

Padec tlaka in A-ponderirana raven zvočne moči v dB(A)

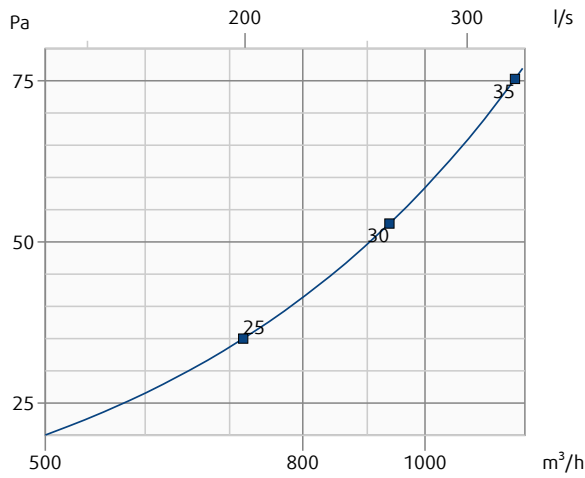

NOVA-EF-625x425-AN

Padec tlaka in A-ponderirana raven zvočne moči v dB(A)

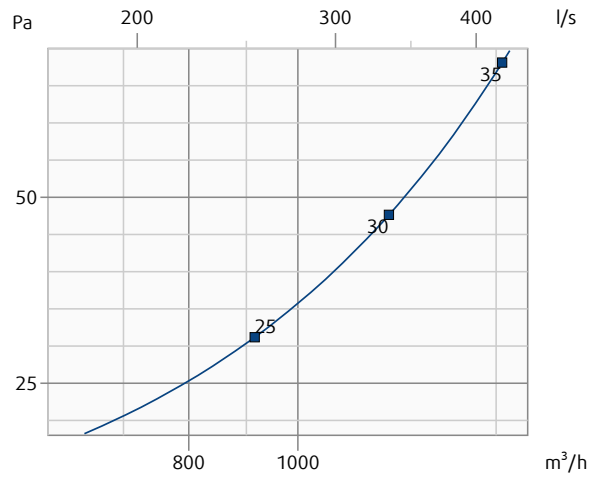

NOVA-EF-625x525-AN

Padec tlaka in A-ponderirana raven zvočne moči v dB(A)

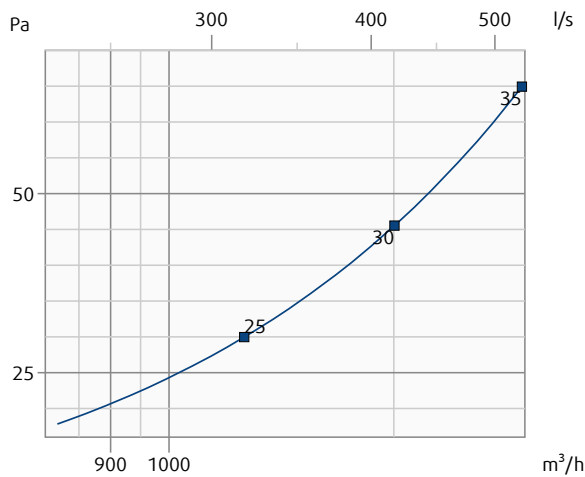

NOVA-EF-800x100-AN

Padec tlaka in A-ponderirana raven zvočne moči v dB(A)

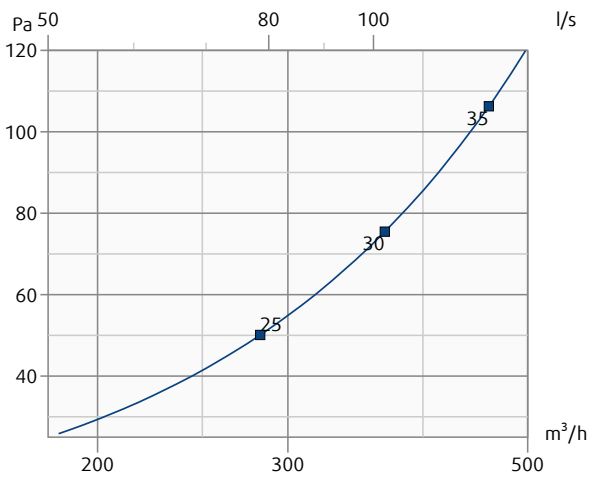

NOVA-EF-800x150-AN

Padec tlaka in A-ponderirana raven zvočne moči v dB(A)

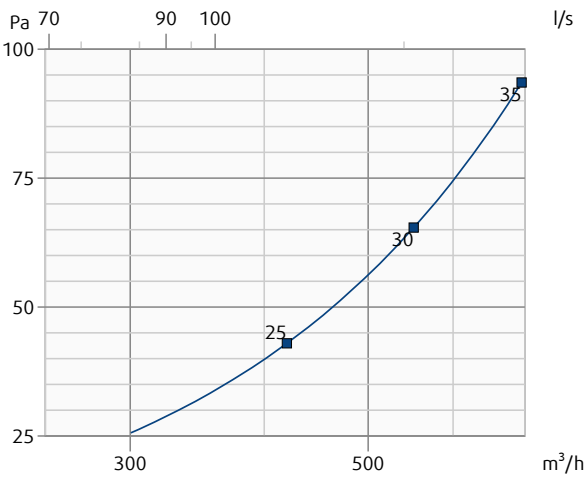

NOVA-EF-800x200-AN

Padec tlaka in A-ponderirana raven zvočne moči v dB(A)

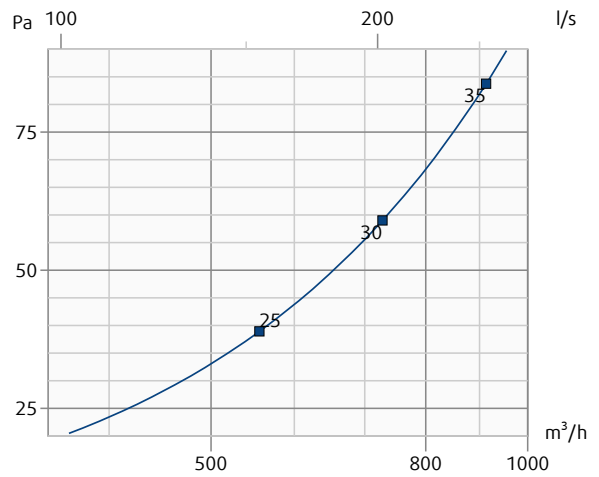

Padec tlaka in raven sevane zvočne moči sta odvisna od količine pretoka zraka.

NOVA-EF-800x300-AN

Padec tlaka in A-ponderirana raven zvočne moči v dB(A)

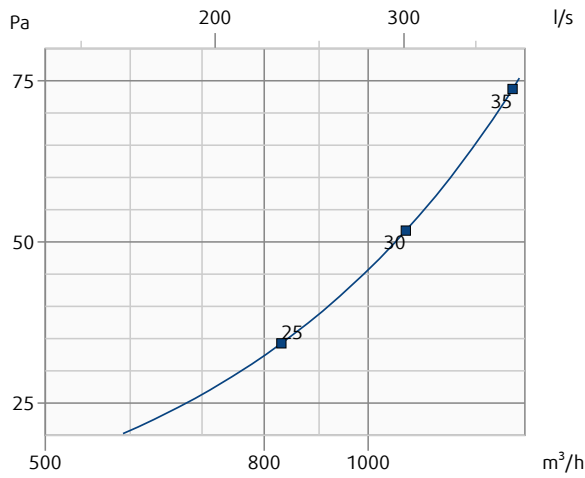

NOVA-EF-800x400-AN

Padec tlaka in A-ponderirana raven zvočne moči v dB(A)

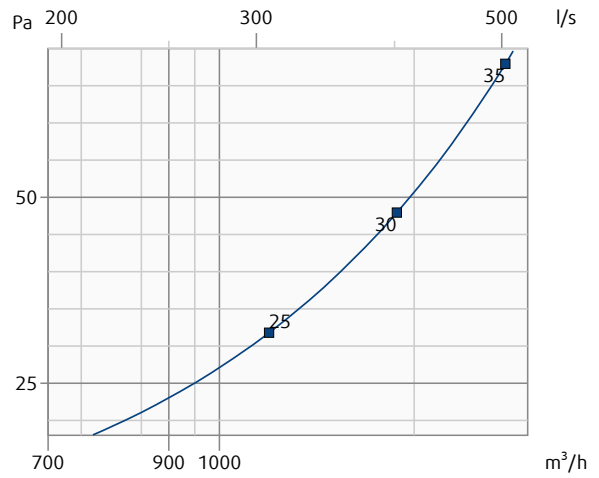

NOVA-EF-800x500-AN

Padec tlaka in A-ponderirana raven zvočne moči v dB(A)

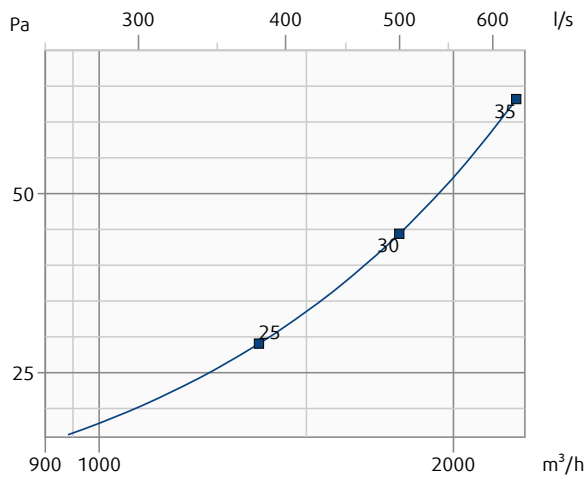

NOVA-EF-825x125-AN

Padec tlaka in A-ponderirana raven zvočne moči v dB(A)

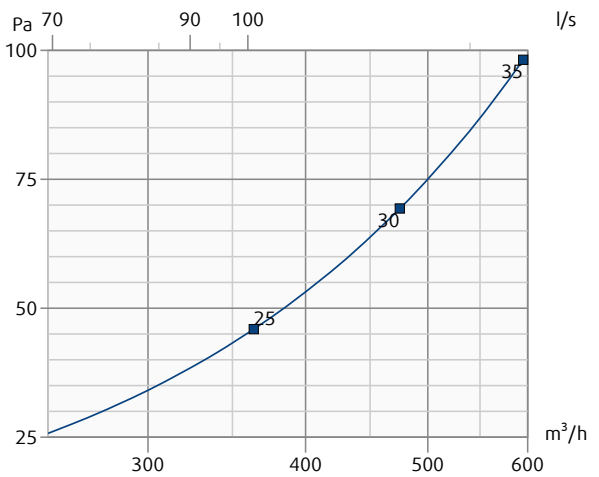

NOVA-EF-825x225-AN

Padec tlaka in A-ponderirana raven zvočne moči v dB(A)

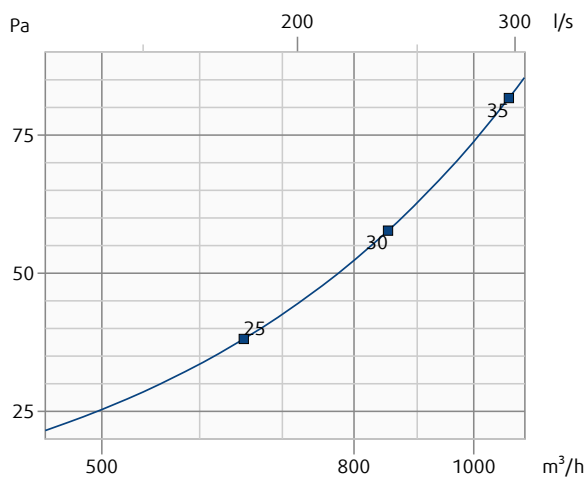

NOVA-EF-825x325-AN

Padec tlaka in A-ponderirana raven zvočne moči v dB(A)

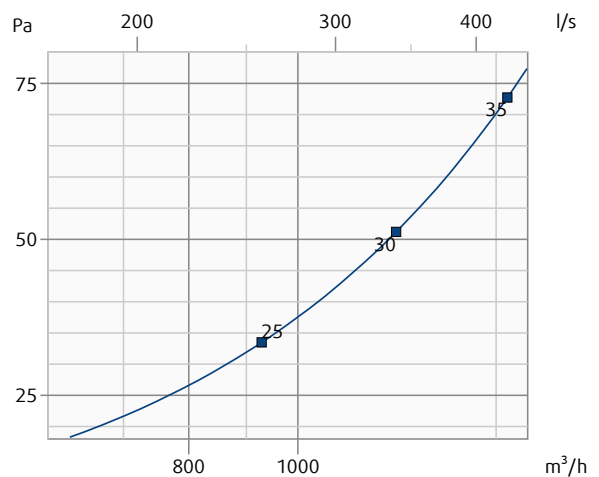

Padec tlaka in raven sevane zvočne moči sta odvisna od količine pretoka zraka.

NOVA-EF-825x425-AN

Padec tlaka in A-ponderirana raven zvočne moči v dB(A)

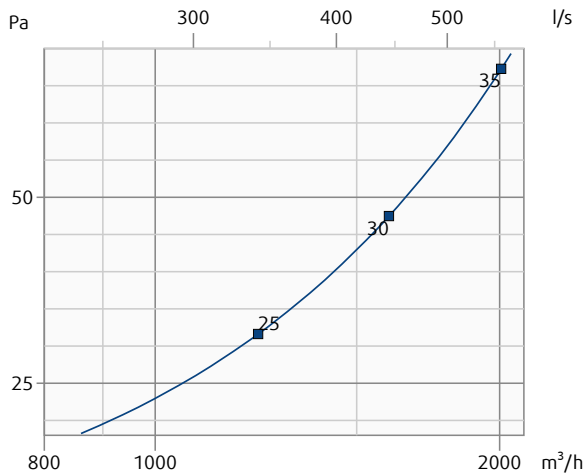

NOVA-EF-825x525-AN

Padec tlaka in A-ponderirana raven zvočne moči v dB(A)

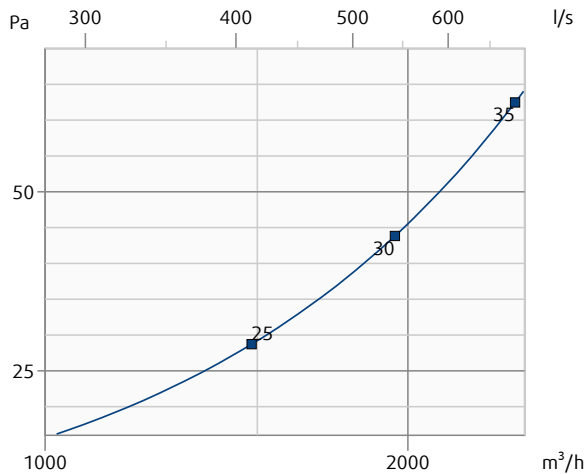

NOVA-EF-1000x100-AN

Padec tlaka in A-ponderirana raven zvočne moči v dB(A)

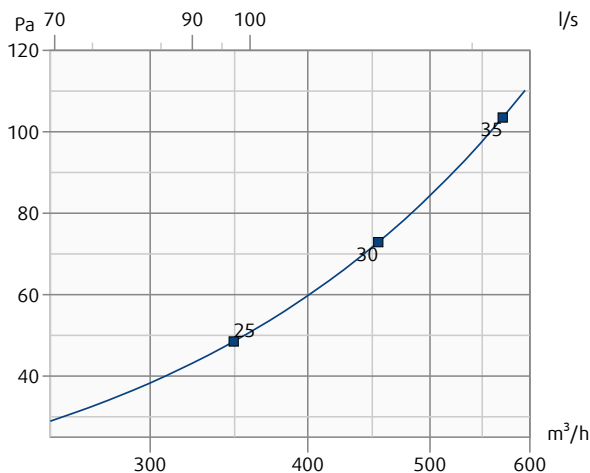

NOVA-EF-1000x150-AN

Padec tlaka in A-ponderirana raven zvočne moči v dB(A)

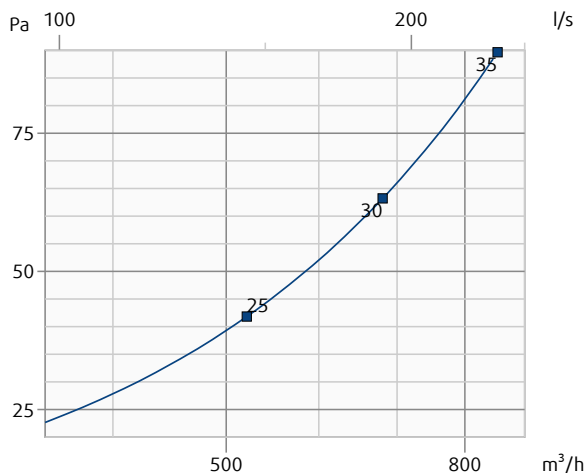

NOVA-EF-1000x200-AN

Padec tlaka in A-ponderirana raven zvočne moči v dB(A)

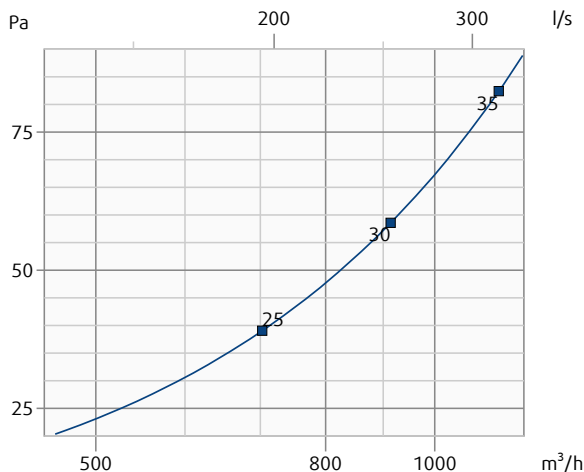

NOVA-EF-1000x300-AN

Padec tlaka in A-ponderirana raven zvočne moči v dB(A)

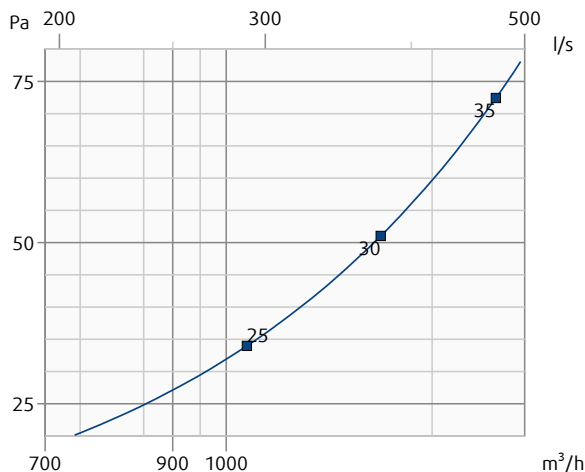

Padec tlaka in raven sevane zvočne moči sta odvisna od količine pretoka zraka.

NOVA-EF-1000x400-AN

Padec tlaka in A-ponderirana raven zvočne moči v dB(A)

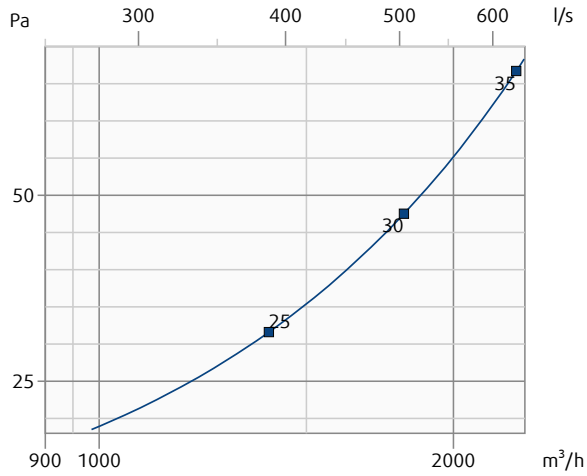

NOVA-EF-1000x500-AN

Padec tlaka in A-ponderirana raven zvočne moči v dB(A)

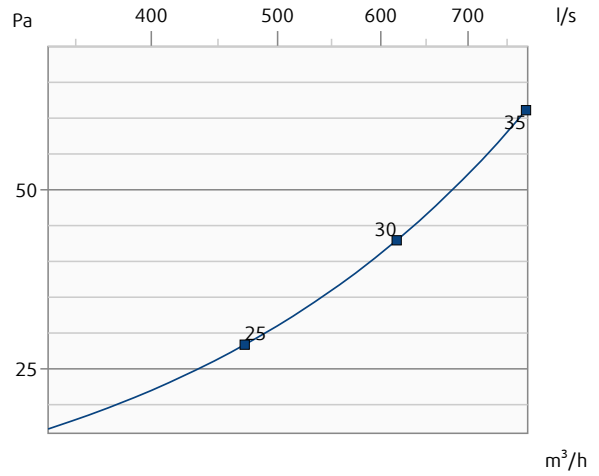

NOVA-EF-1025x125-AN

Padec tlaka in A-ponderirana raven zvočne moči v dB(A)

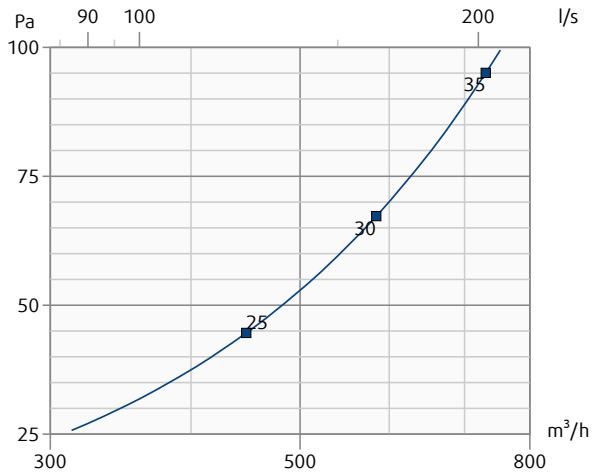

NOVA-EF-1025x225-AN

Padec tlaka in A-ponderirana raven zvočne moči v dB(A)

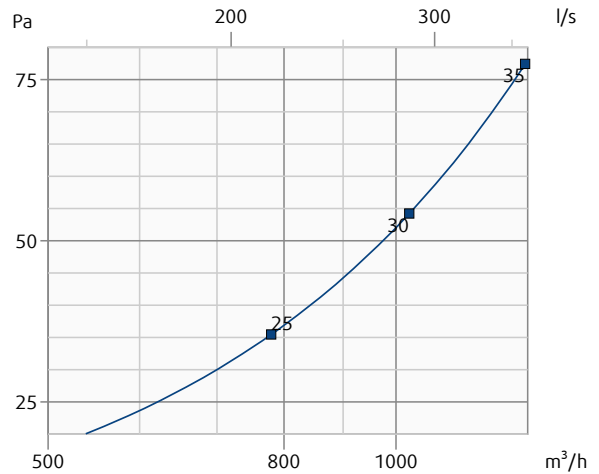

NOVA-EF-1025x325-AN

Padec tlaka in A-ponderirana raven zvočne moči v dB(A)

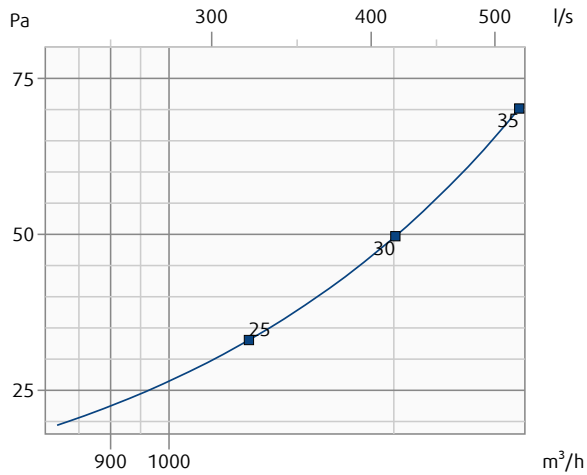

NOVA-EF-1025x425-AN

Padec tlaka in A-ponderirana raven zvočne moči v dB(A)

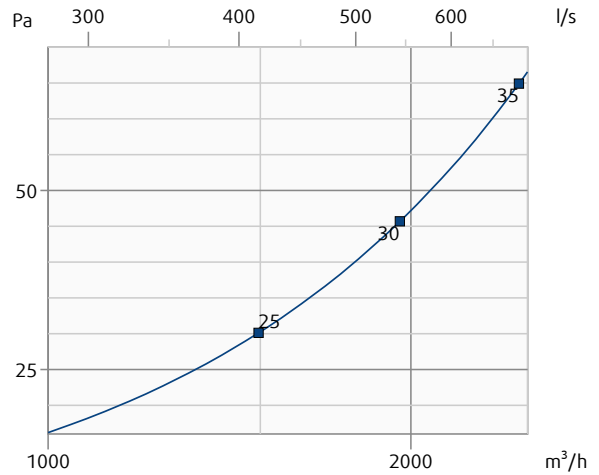

Padec tlaka in raven sevane zvočne moči sta odvisna od količine pretoka zraka.

NOVA-EF-1025x525-AN

Padec tlaka in A-ponderirana raven zvočne moči v dB(A)

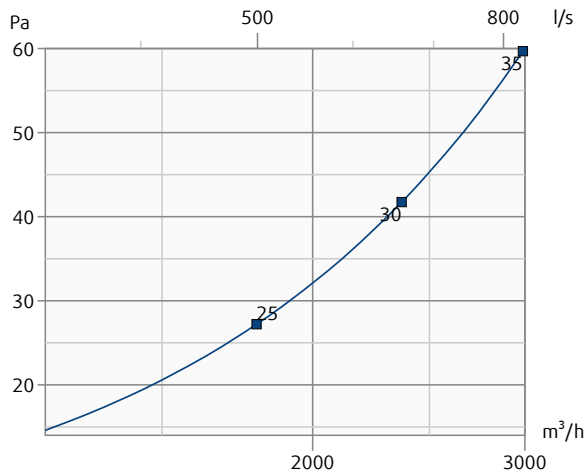

NOVA-EF-1200x100-AN

Padec tlaka in A-ponderirana raven zvočne moči v dB(A)

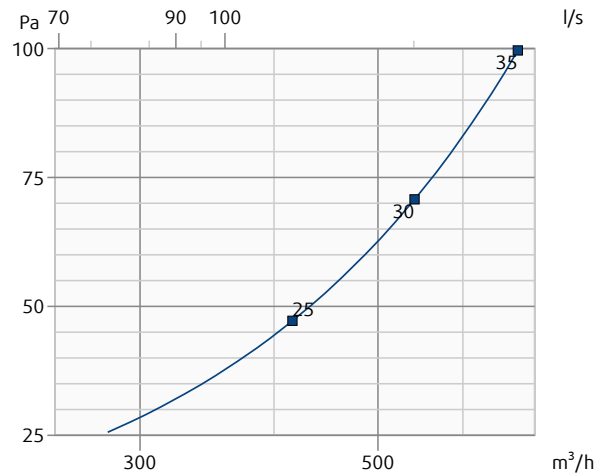

NOVA-EF-1200x150-AN

Padec tlaka in A-ponderirana raven zvočne moči v dB(A)

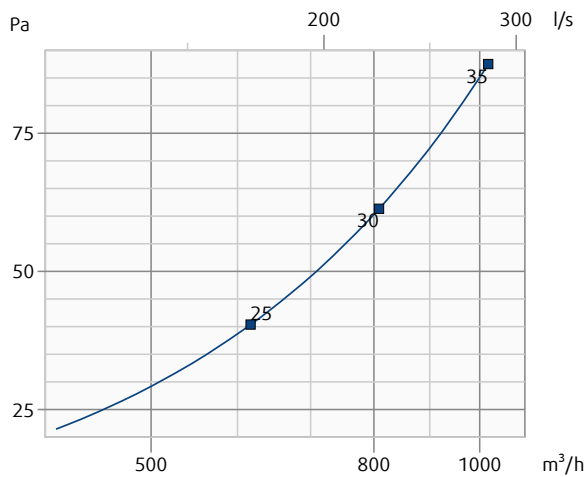

NOVA-EF-1200x200-AN

Padec tlaka in A-ponderirana raven zvočne moči v dB(A)

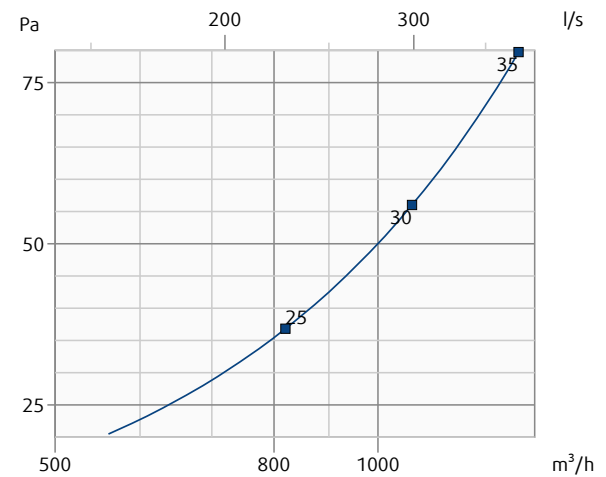

NOVA-EF-1200x300-AN

Padec tlaka in A-ponderirana raven zvočne moči v dB(A)

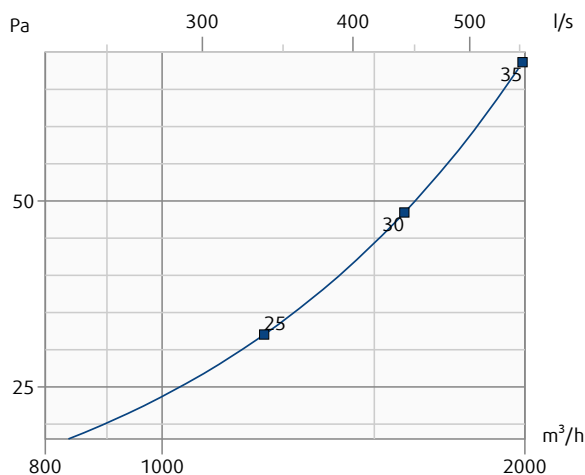

NOVA-EF-1200x400-AN

Padec tlaka in A-ponderirana raven zvočne moči v dB(A)

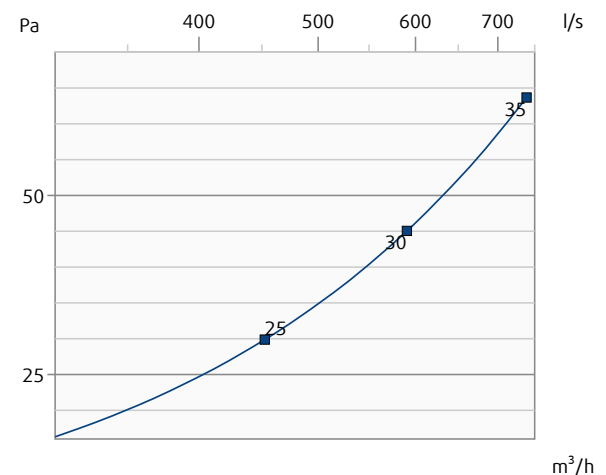

Padec tlaka in raven sevane zvočne moči sta odvisna od količine pretoka zraka.

NOVA-EF-1200x500-AN

Padec tlaka in A-ponderirana raven zvočne moči v dB(A)

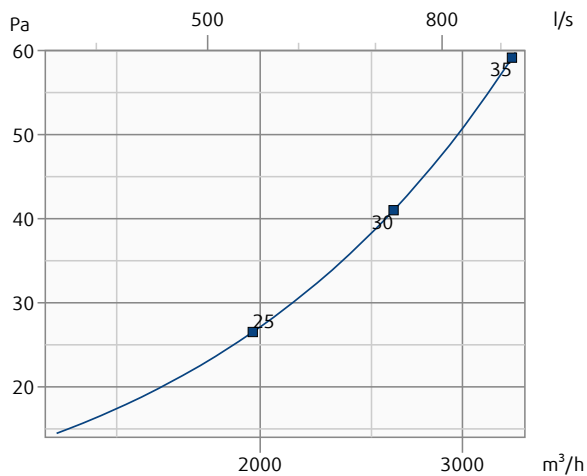

NOVA-EF-1225x125-AN

Padec tlaka in A-ponderirana raven zvočne moči v dB(A)

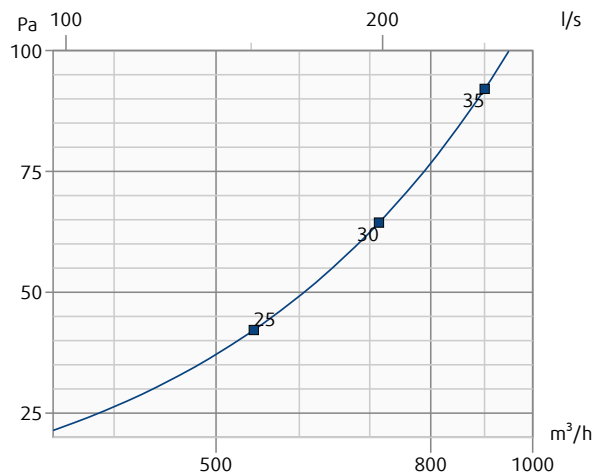

NOVA-EF-1225x225-AN

Padec tlaka in A-ponderirana raven zvočne moči v dB(A)

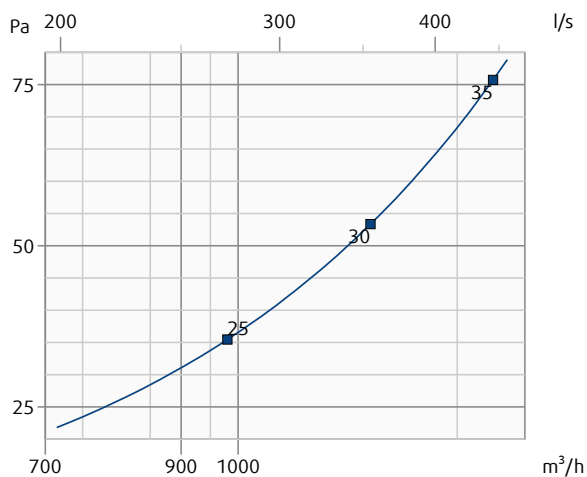

NOVA-EF-1225x325-AN

Padec tlaka in A-ponderirana raven zvočne moči v dB(A)

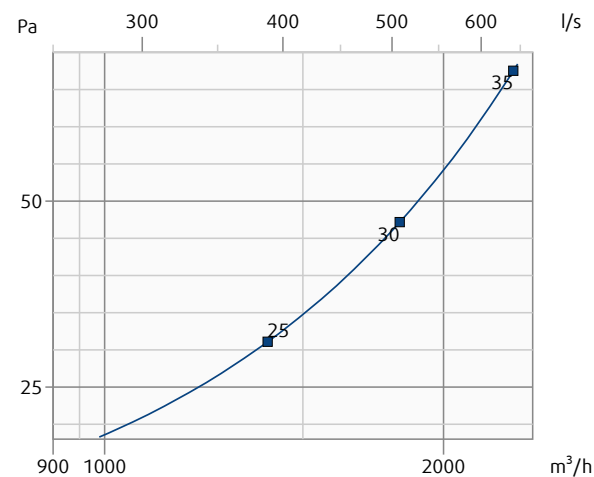

NOVA-EF-1225x425-AN

Padec tlaka in A-ponderirana raven zvočne moči v dB(A)

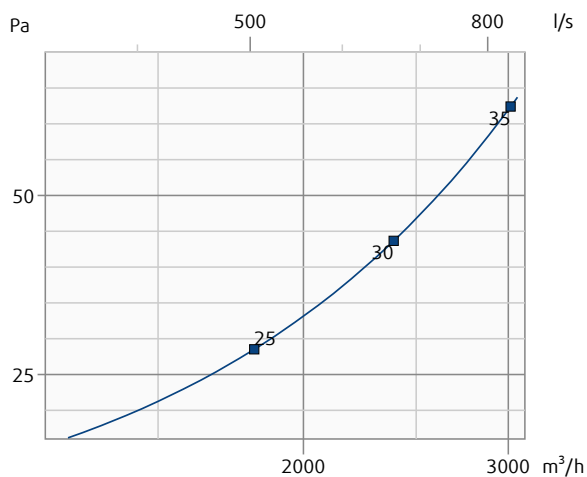

NOVA-EF-1225x525-AN

Padec tlaka in A-ponderirana raven zvočne moči v dB(A)

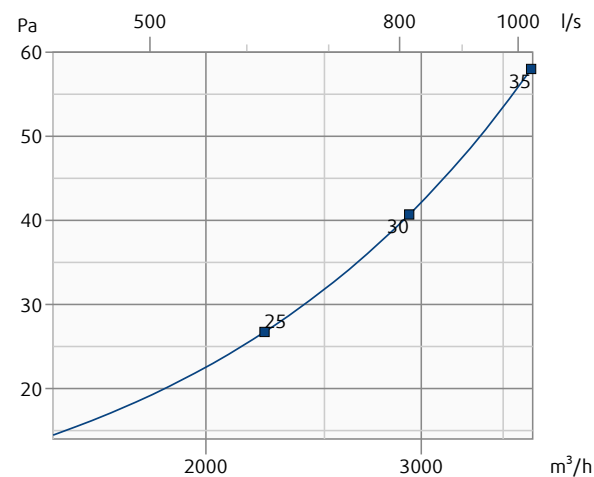

Namestitev

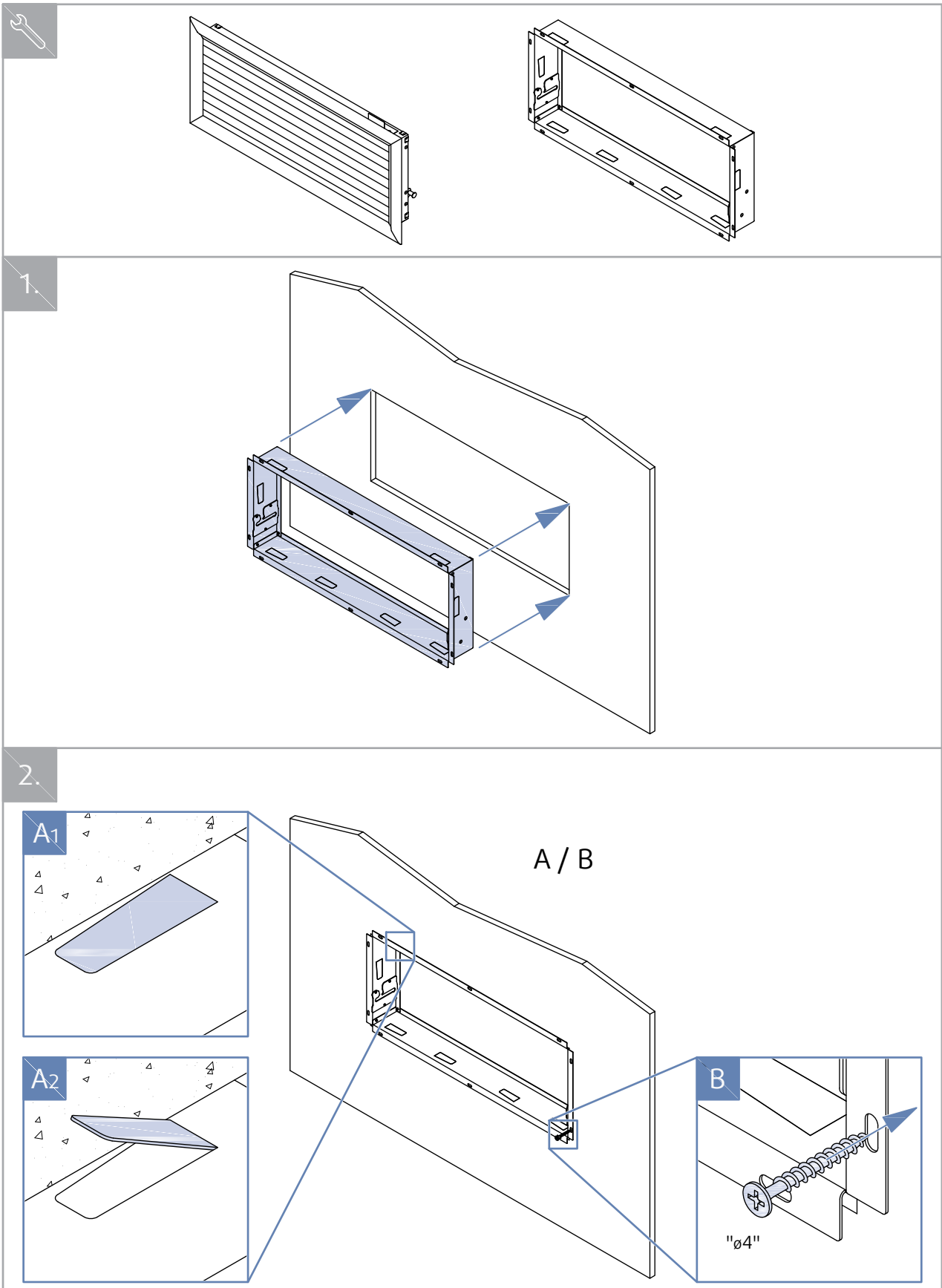

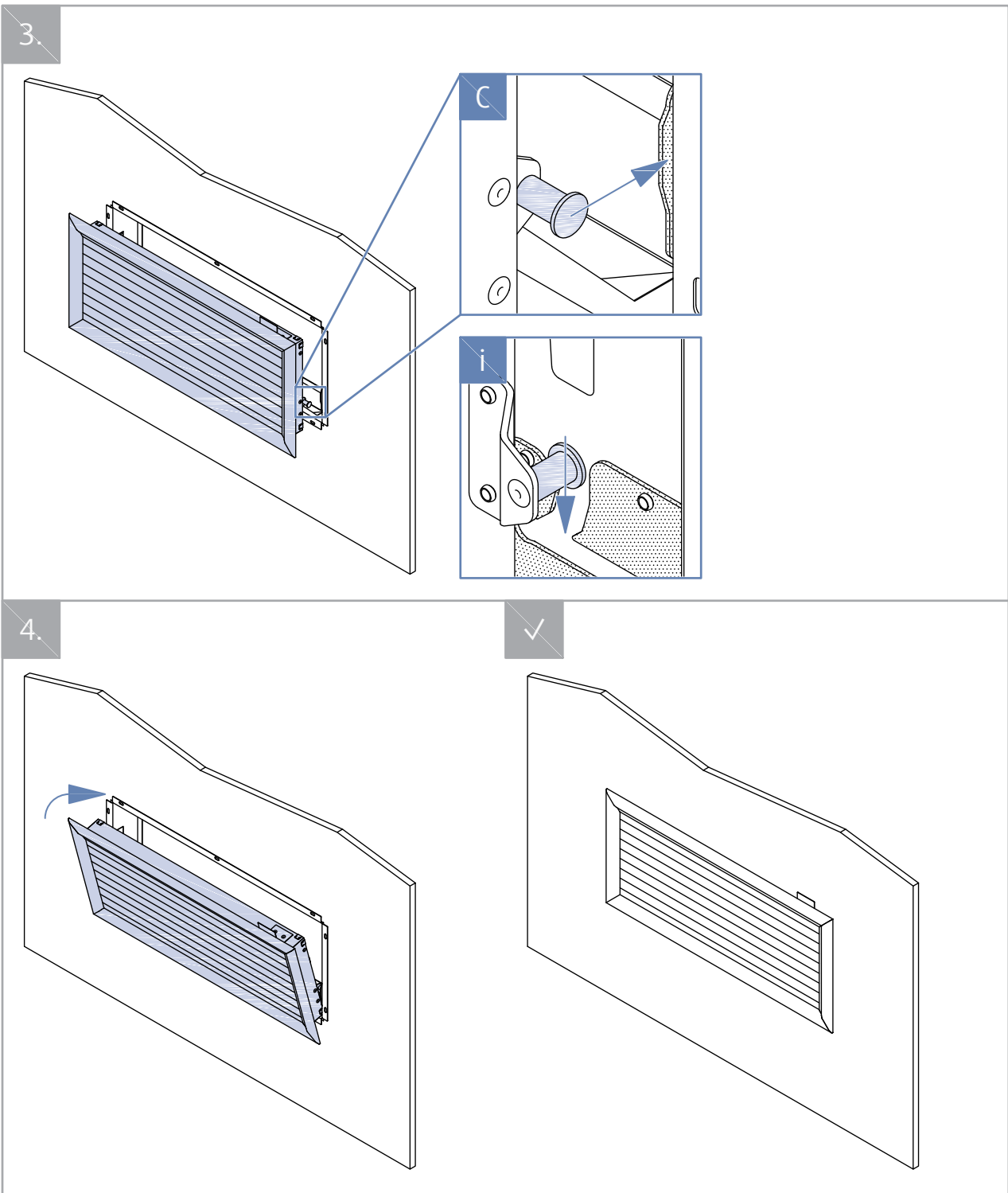

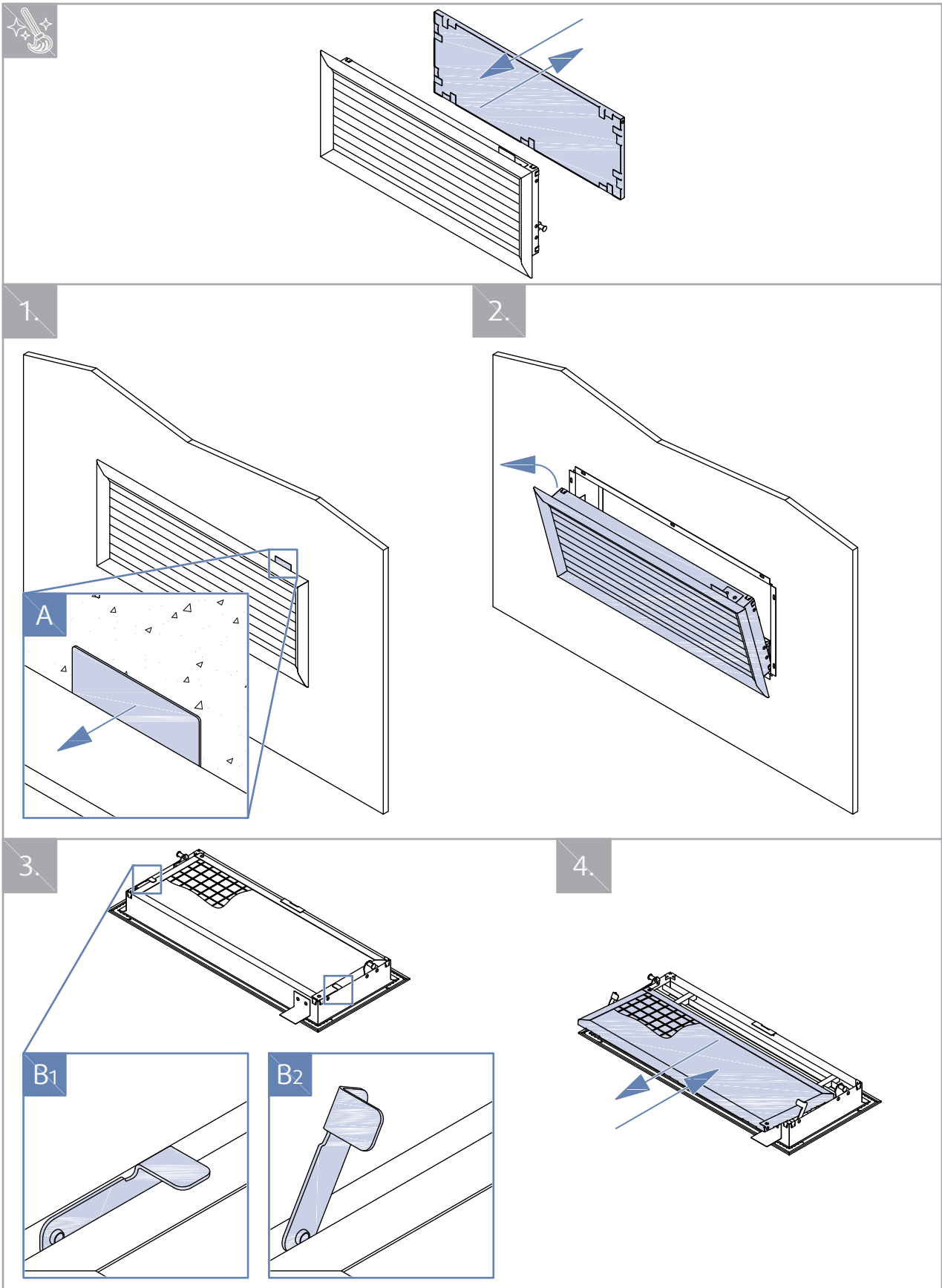

Transport, skladiščenje in uporaba

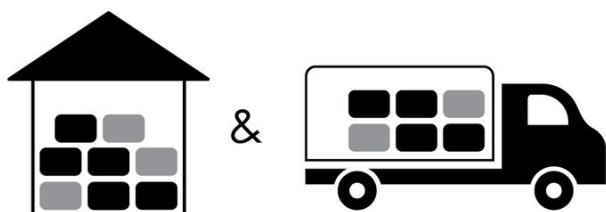

 °C -40°C ... +50°C

 % ≤ 95%



 °C -20°C ... +70°C

 % ≤ 95%

Dodatek

V primeru odstopanja izdelka od navedenih tehničnih specifikacij, se je treba obrniti na proizvajalca. Pridržujemo si pravico do kakršnih koli sprememb izdelka brez predhodnega obvestila, pod pogojem, da te spremembe ne vplivajo na kakovost izdelka in zahtevane parametre.

Aktualne informacije o vseh izdelkih, so na voljo na design.systemair.com.

