

# S-RA1

## Smoke Control Damper - AAsingle

Handbook



# Table of Contents

Overview . . . . .	.3
Technical Parameters . . . . .	.5
Diagrams . . . . .	.7
Dimensions & Weights . . . . .	.13
Ordering Code . . . . .	.15
Product Handling . . . . .	.16
Installation . . . . .	.18
Electrical Parameters . . . . .	.23
Operation Manual . . . . .	.29



## Description

S-RA1 smoke control dampers operate with mechanical or natural smoke and heat extraction systems. They remove poisonous gases, smoke and fire and can also supply clean air to fire compartments.

S-RA1 dampers have an actuator without a spring. Thus, they have two safety positions: an “open” position and a “closed” one. Power is necessary for the smoke control dampers.

The “Installation Methods” section shows the types of installations that are permitted.

### Special Properties

- The pressure level is 2 (-1000 Pa ... 300 Pa).
- The casing leakage class C (compliant with EN 1751).
- The blade leakage class 3 (compliant with EN 1751).

### Fire Resistivity

S-RA1 smoke control dampers have a CE certification that meets the EU’s Construction Products Regulation and complies with Standard EN 12101-8:2011. EN 1366-10:2011 + A1:2017, and EN 1366-2:2015 are the reference Standards for the tests. EN 13501-4:2016 is the reference Standard for the Classification.

Resistivity rating for damper installed on the duct: **E<sub>600</sub> 120 (v<sub>ed</sub> - i↔o) S1000 C<sub>mod</sub> AAsingle**

### Types of Activation

- **B230** - Smoke control damper with an activation mechanism with a Belimo actuator (230V AC) and auxiliary switches.
- **B24** - Smoke control damper with an activation mechanism with a Belimo actuator (24V AC/DC) and auxiliary switches.
- **B24-W** - Smoke control damper with an activation mechanism with a Belimo actuator (24V AC/DC) and auxiliary switches, with provided cable connectors for the supply and communication unit (communication unit not part of the mechanism).
- **B24-SR** - Smoke control damper with an activation mechanism with a modulating Belimo actuator (24V AC/DC; 0(2) V...10 V DC) and auxiliary switches. Modulating actuators have the possibility to open the blade at a desired angle.

### Accessories

You can find more information about accessories at [design.systemair.com](http://design.systemair.com).

- GE1-S-RA1: Extension with Grille for S-RA1

# Design

The casing and the blade of the S-RA1 are made of a galvanized sheet metal. A rubber seal prevents leaks of heat or smoke. The casing has connections on two sides with a rubber seal to attach to duct with nominal internal dimension. The dampers actuator of the S-RA1 is always accessible.

## Composition of Materials

The product contains these materials:

- galvanized sheet metal
- rubber
- PE tapes and foil
- galvanized steel fasteners

The manufacturing processes of these materials agree with local regulations. The product does not contain dangerous materials.

## Product Parts

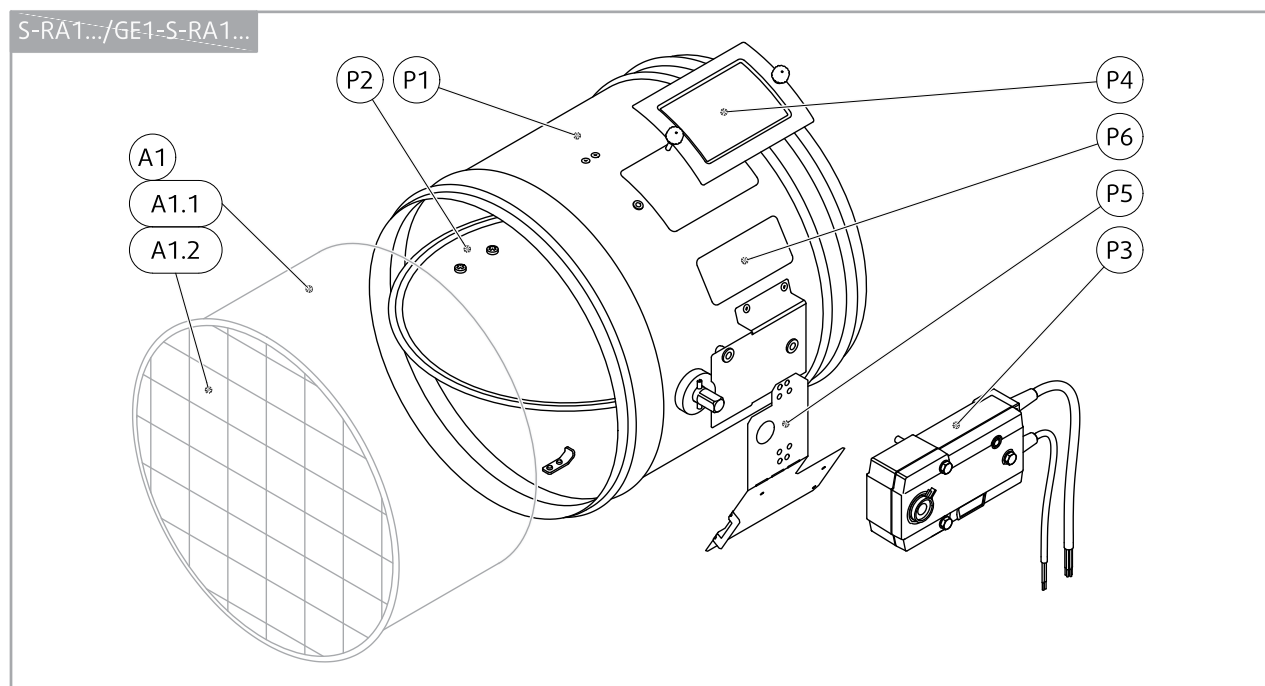

### Legend:

- P1** - Damper casing
- P2** - Damper blade
- P3** - Actuator
- P4** - Inspection lid
- P5** - Holder for communication unit (only for B24T-W activation type)
- P6** - Product label
- A1** - Extension with Grille (GE1-S-RA1) is not part of S-RA1 delivery.
  - A1.1** - Extended ductwork
  - A1.2** - Grid

# Technical Parameters

## Durability Test

- Test procedure with 10000 cycles and actuator control (rotation from 0° to 90°)
- Test procedure with 10000 cycles and actuator control for "mod" classification (rotation from 45° to 60°)
- No change of the necessary properties.
- No change of the necessary properties.

## Tested Pressures

- Maximum pressure at ambient temperatures • 1000 Pa
- Maximum pressure during fire • 300 Pa

## Safe Position

Open or closed

## Possible Installations

Refer to the "Installation Methods" section

## Direction of the Airflow

Both direction for supply or extract

## Permitted air velocity during blade movement

12 m/s

## Side with Fire Protection

Both sides: (i<->o) - symmetrical

## Closing and Opening Time

Motor running time: <60 s / 90°

## Closed or Open Status Indicator

Microswitches that are part of the mechanism actuator signal the closed or open status.

## Environmental Conditions for Operation (not fire scenario)

- The temperatures must be: -20 °C ... 50 °C
- Relative humidity: Less than 95% (3K5, EN 60721-3-3)
- Product protected from: Weather, rain and water from other sources
- Condensation: Cannot form on the product
- Icing: Cannot form on the product

## Access for Inspection

The inspection is possible through the grille when available or through an inspection opening on the damper body. Connection and actuator accessible from outside.

## Maintenance

Maintenance is not necessary. A dry-cleaning procedure can be mandatory in some countries.

## Inspections

Obey local laws for the minimum time between inspection procedures. When not specified the maximum interval between inspections is 6 months.

## Tightness of the Blade

Class 3 of standard EN 1751 at 500 Pa

## Tightness of the Housing

Class C of standard EN 1751 at 500 Pa

## EC Directives

- 2006/42/EC Machinery Directive
- 2014/35/EU Low Voltage Directive
- 2014/30/EU Electromagnetic Compatibility Directive

## Driving Actuator Types

Belimo BEN... ..230; ...24; ...24-ST; ...24-SR

## Transportation and Storage

The temperature range must be: -30...50 °C

Make sure that the damper blade is in the closed position during transportation and protected from weather disruptions. The storage of the smoke control damper must be indoors.

# Assessed Performance

19 CE 1396

## Systemair Production a.s.

Hlavná 371, 900 43 Kalinkovo, Slovakia

1396-CPR-0207

S-RA1

### EN 12101-8 : 2011

Smoke control damper

#### Nominal activation conditions/sensitivity

Pass

#### Response delay (response time)

Opening/closure time proven. Duration: &lt;60 s / 90°

#### Operational reliability

C<sub>mod</sub>: 20.000 cycles (modulated)

#### Fire resistance:

E<sub>600</sub> 120 (v<sub>ed</sub> - i ↔ o) S1000 C<sub>mod</sub> AAsingle

Resistivity depends on installation method and situation

- integrity

E

maintenance of the cross section

(under E)

mechanical stability

(under E)

- smoke leakage

S

#### Durability of response delay

AA - Automatic Activation. Opening/closure time proven. Duration: &lt;60 s / 90°

#### Durability of operational reliability

C<sub>mod</sub>: 20.000 cycles. Cycle duration: <120 s

# Diagrams

The pressure drop, and A-weighted total discharged sound power level depend on the nominal diameter of the damper and air flow volume at different duct pressures. The type of activation does not influence the airflow parameter, therefore only one activation type is shown in the diagrams.

## Diagrams for Extract

### S-RA1-...-B230

Pressure drop & A-weighted sound power level in dB(A)

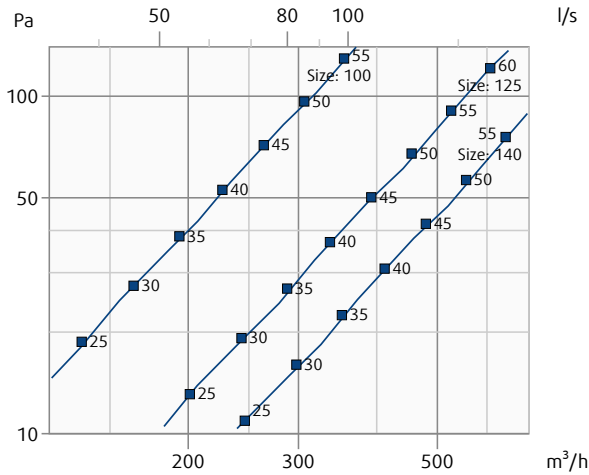

### S-RA1-...-B230

Pressure drop & A-weighted sound power level in dB(A)

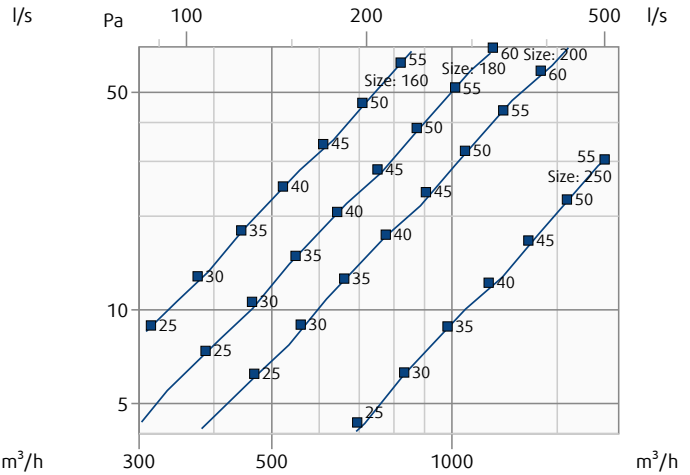

### S-RA1-...-B230

Pressure drop & A-weighted sound power level in dB(A)

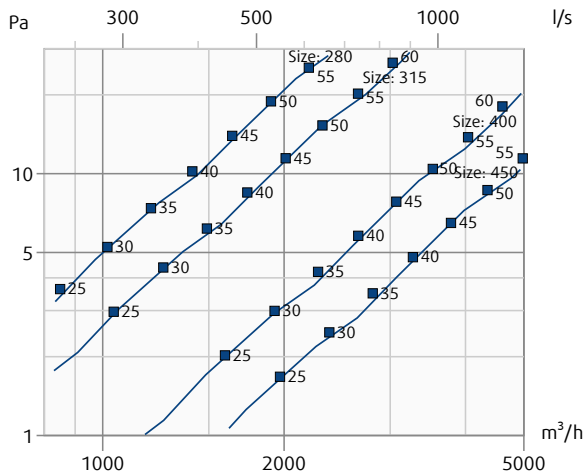

### S-RA1-...-B230

Pressure drop & A-weighted sound power level in dB(A)

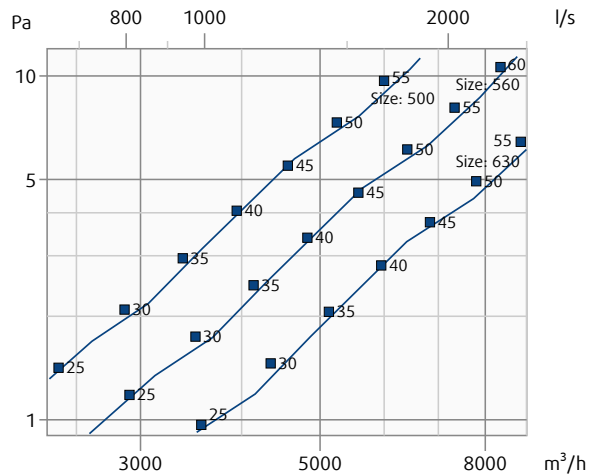

S-RA1-...-B24-SR

Pressure drop & A-weighted sound power level in dB(A)

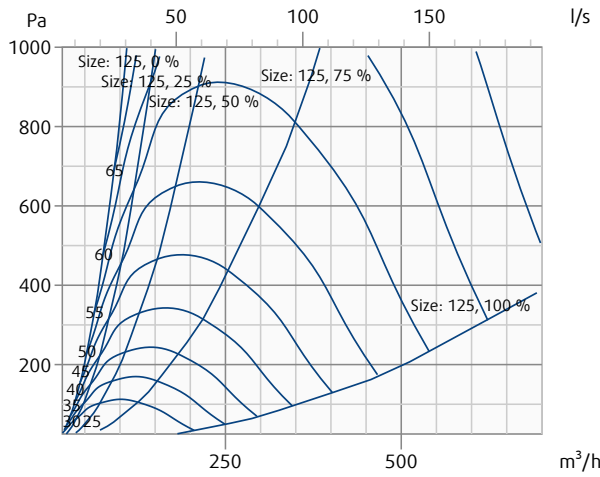

S-RA1-...-B24-SR

Pressure drop & A-weighted sound power level in dB(A)

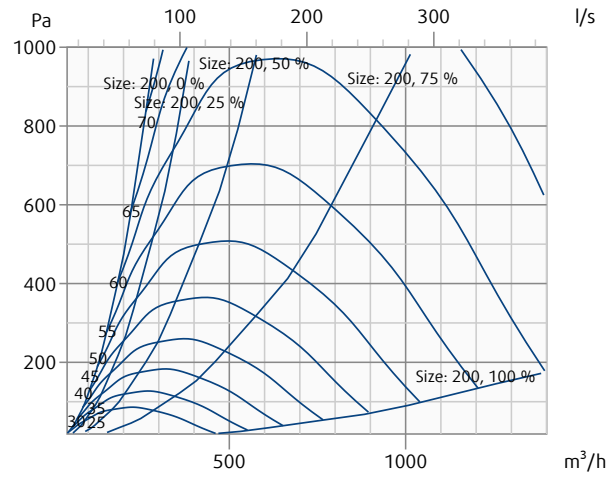

S-RA1-...-B24-SR

Pressure drop & A-weighted sound power level in dB(A)

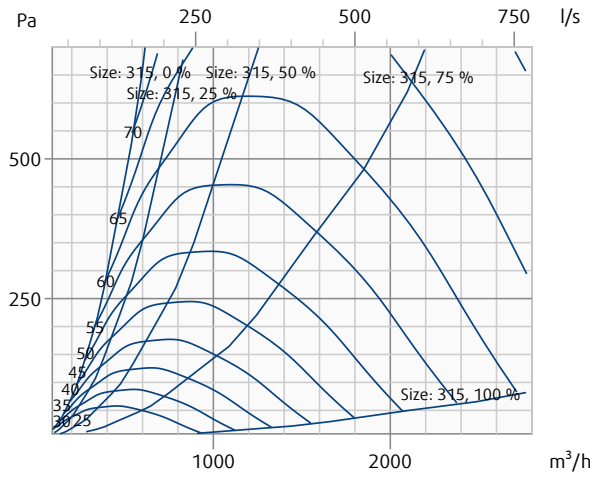

S-RA1-...-B24-SR

Pressure drop & A-weighted sound power level in dB(A)

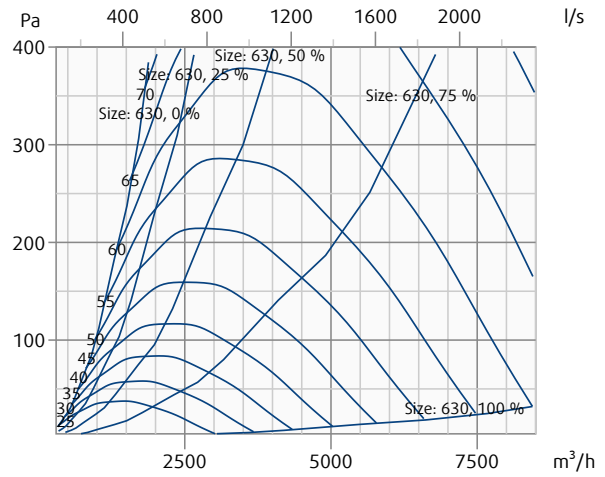

Legend:

**Pa** - Pressure drop ( $p_s$ )

**m³/h; l/s** - Airflow volume ( $q_v$ )



Diagrams for Supply

S-RA1-...-B230

Pressure drop & A-weighted sound power level in dB(A)

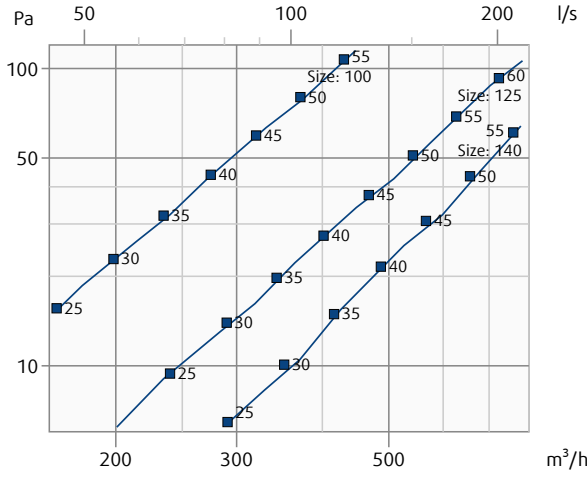

S-RA1-...-B230

Pressure drop & A-weighted sound power level in dB(A)

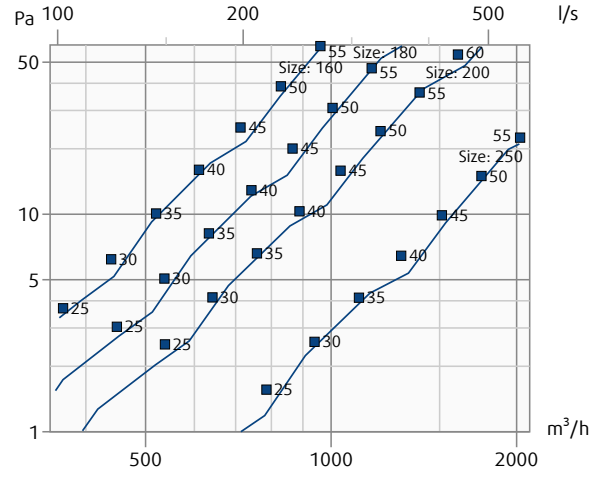

S-RA1-...-B230

Pressure drop & A-weighted sound power level in dB(A)

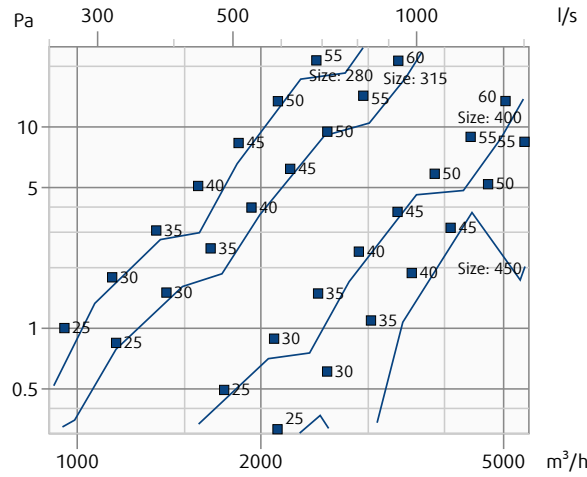

S-RA1-...-B230

Pressure drop & A-weighted sound power level in dB(A)

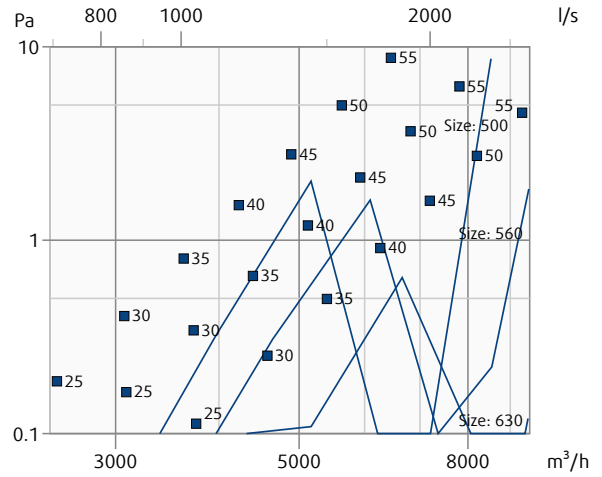

S-RA1-...-B24-SR

Pressure drop & A-weighted sound power level in dB(A)

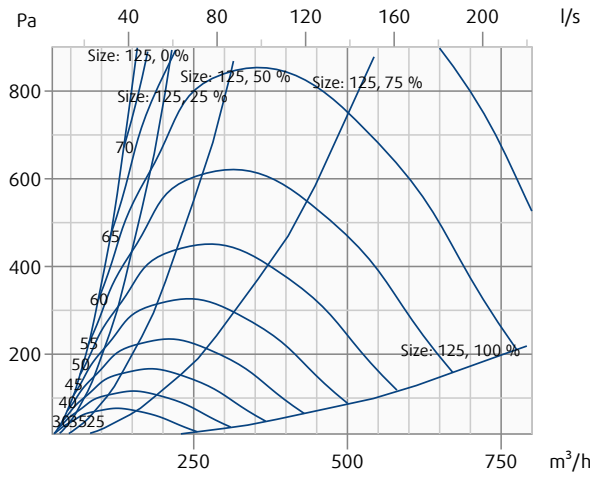

S-RA1-...-B24-SR

Pressure drop & A-weighted sound power level in dB(A)

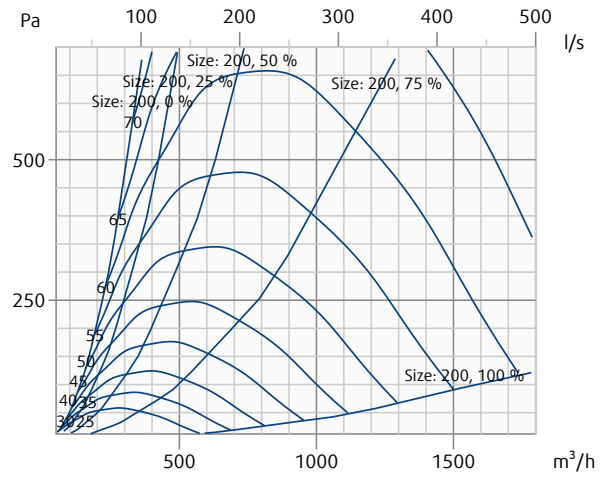

S-RA1-...-B24-SR

Pressure drop & A-weighted sound power level in dB(A)

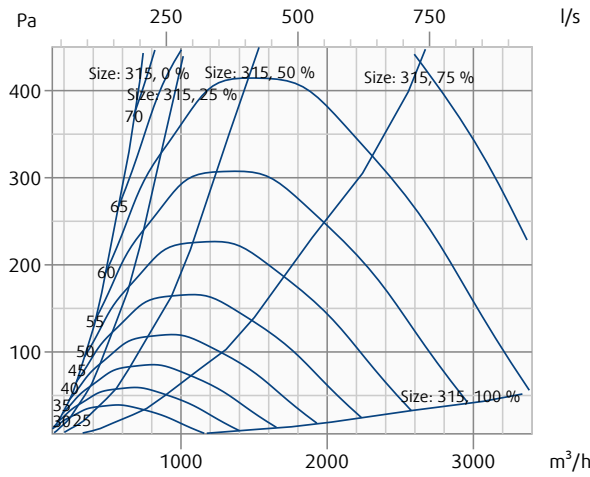

S-RA1-...-B24-SR

Pressure drop & A-weighted sound power level in dB(A)

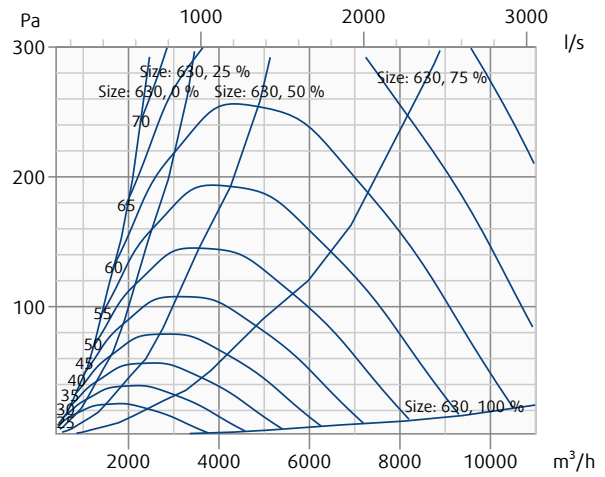

Legend:

**Pa** - Pressure drop ( $p_s$ )

**m³/h; l/s** - Airflow volume ( $q_v$ )

Diagrams for Extract with Included GE1-S-RA1 Accessory

S-RA1-...-B230 + GE1-S-RA1-...-

Pressure drop & A-weighted sound power level in dB(A)

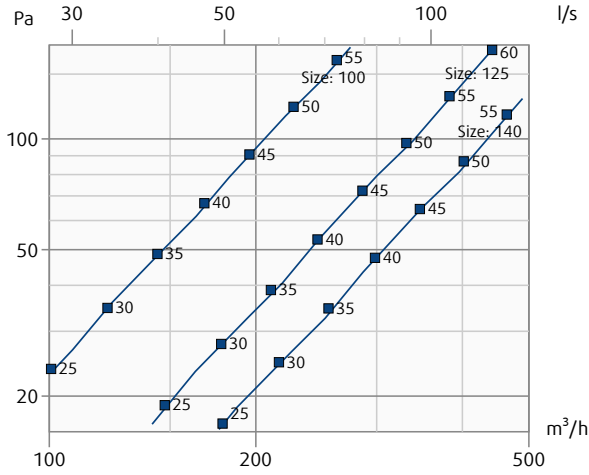

S-RA1-...-B230 + GE1-S-RA1-...-

Pressure drop & A-weighted sound power level in dB(A)

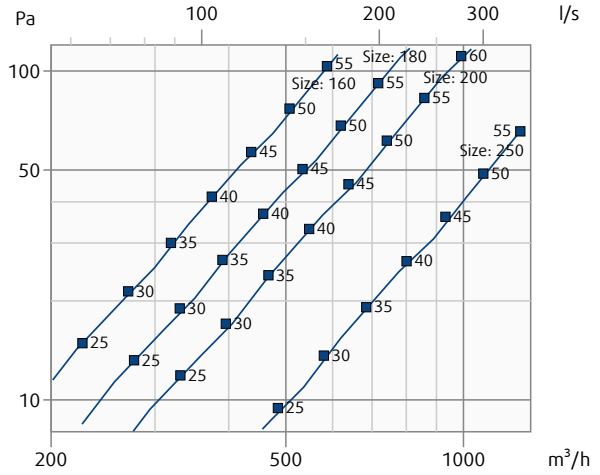

S-RA1-...-B230 + GE1-S-RA1-...-

Pressure drop & A-weighted sound power level in dB(A)

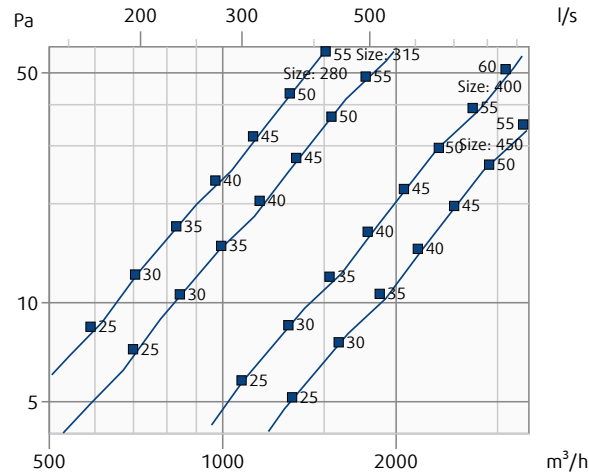

S-RA1-...-B230 + GE1-S-RA1-...-

Pressure drop & A-weighted sound power level in dB(A)

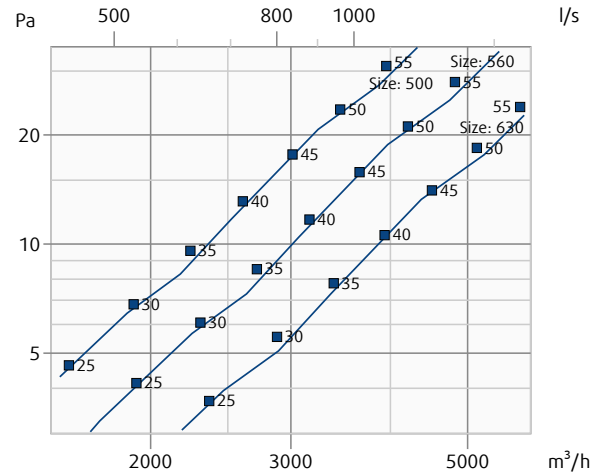

S-RA1-...-B24-SR + GE1-S-RA1-...-

Pressure drop & A-weighted sound power level in dB(A)

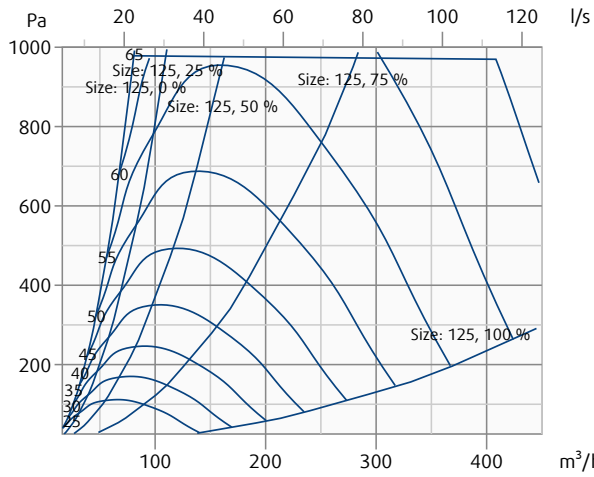

S-RA1-...-B24-SR + GE1-S-RA1-...-

Pressure drop & A-weighted sound power level in dB(A)

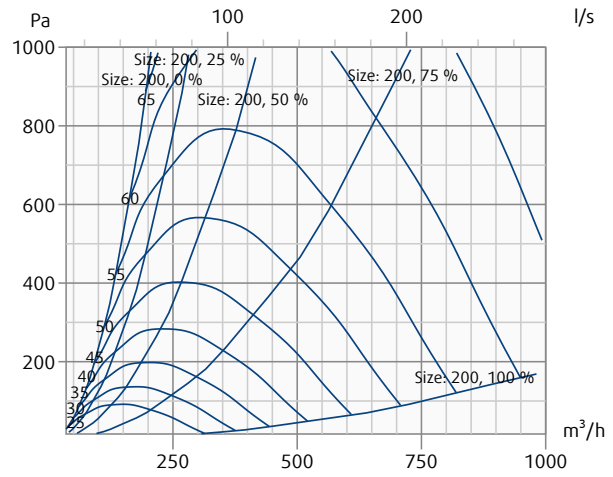

S-RA1-...-B24-SR + GE1-S-RA1-...-

Pressure drop & A-weighted sound power level in dB(A)

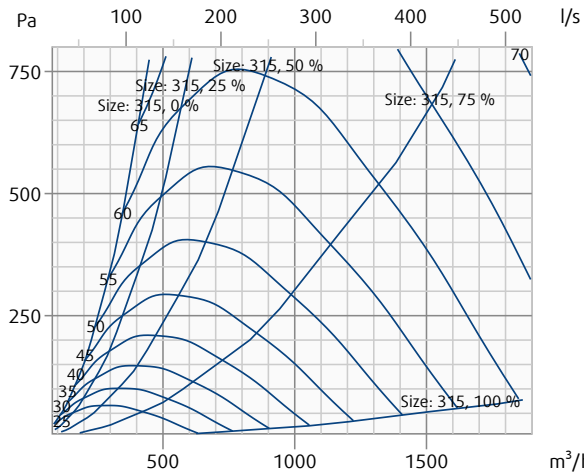

S-RA1-...-B24-SR + GE1-S-RA1-...-

Pressure drop & A-weighted sound power level in dB(A)

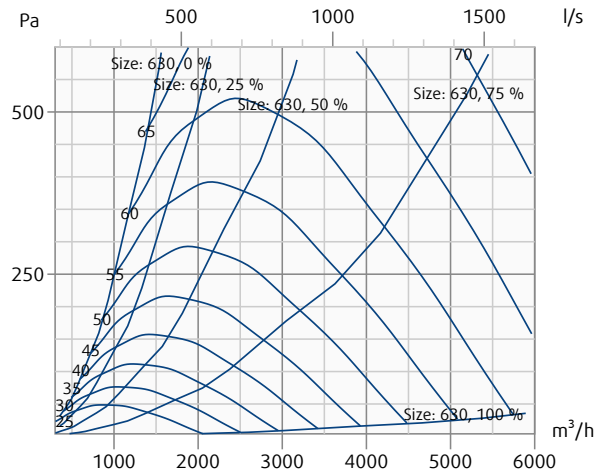

Legend:

**Pa** - Pressure drop ( $p_s$ )

**m³/h; l/s** - Airflow volume ( $q_v$ )

# Dimensions & Weights

## Dimensions

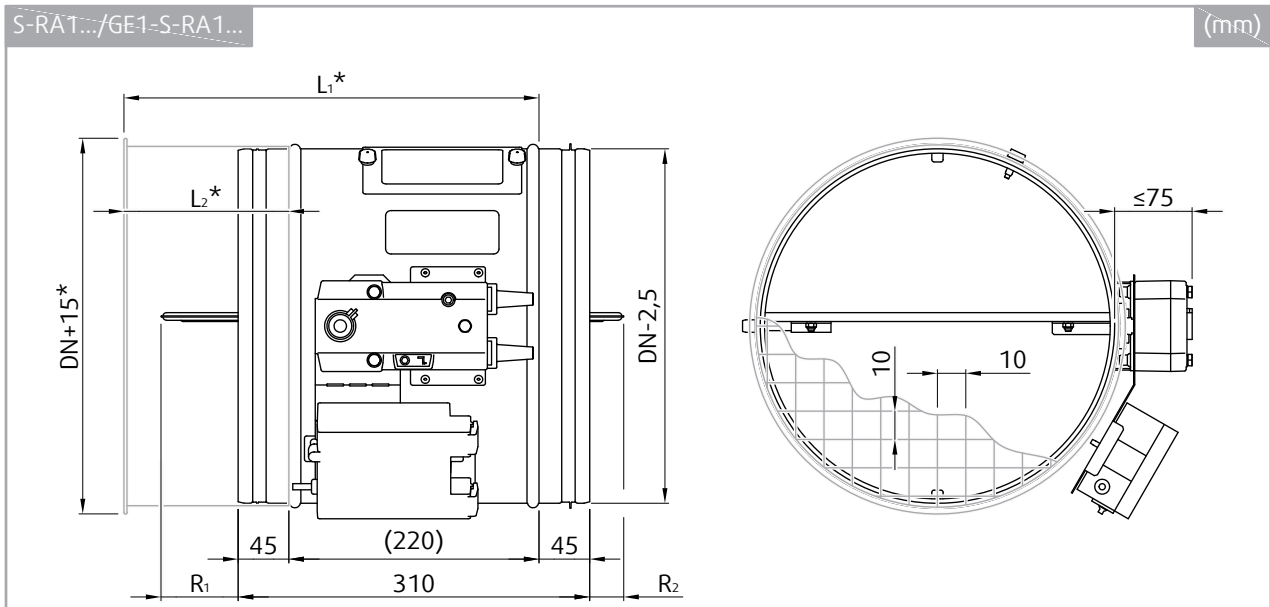

### Notes:

Accessory GE1-S-RA1 sold separately. GE1-S-RA1 is not part of the S-RA1 delivery.

\* Inclusive grille

S-RA1	DN (mm)																
	100	125	140	150	160	180	200	225	250	280	315	355	400	450	500	560	630
R <sub>1</sub>	-40	-28	-20	-15	-10	0	10	23	35	50	68	88	110	135	160	190	225
R <sub>2</sub>	-170	-158	-150	-145	-140	-130	-120	-108	-95	-80	-63	-43	-20	5	30	60	95
L <sub>1</sub>	270			290			340			400			450		520		
L <sub>2</sub>	50			70			120			180			230		300		

**Free Area of S-RA1 Without Grille**

A <sub>v</sub> (m <sup>2</sup> )	DN (mm)																
	100	125	140	150	160	180	200	225	250	280	315	355	400	450	500	560	630
S-RA1	0,005	0,008	0,01	0,012	0,014	0,019	0,024	0,032	0,04	0,051	0,067	0,086	0,111	0,143	0,178	0,226	0,289

**Free Area of GE1-S-RA1 Accessory**

A <sub>v</sub> (m <sup>2</sup> )	DN (mm)																
	100	125	140	150	160	180	200	225	250	280	315	355	400	450	500	560	630
GE1-S-RA1	0,003	0,005	0,007	0,008	0,010	0,013	0,016	0,022	0,027	0,035	0,046	0,060	0,077	0,097	0,121	0,154	0,198

**Weights of S-RA1 Without Grille**

m (kg)		DN (mm)																
		100	125	140	150	160	180	200	225	250	280	315	355	400	450	500	560	630
S-RA1	B230, B24, B24-SR	2,2	2,4	2,5	2,7	2,8	3	3,2	3,4	3,7	4,1	4,5	5	5,7	6,5	7,2	8,2	9,4
	B24-W	2,3	2,5	2,6	2,8	2,9	3,1	3,3	3,6	3,8	4,2	4,6	5,1	5,8	6,6	7,4	8,3	9,5

**Weights of S-RA1 with GE1-S-RA1 Accessory**

m (kg)		DN (mm)																
		100	125	140	150	160	180	200	225	250	280	315	355	400	450	500	560	630
GE1-S-RA1	B230, B24, B24-SR	2,4	2,7	2,8	3,1	3,3	3,6	4,1	4,4	4,9	5,4	6,5	7,3	8,4	10,2	11,5	14,1	16,3
	B24-W	2,5	2,8	2,9	3,2	3,4	3,7	4,2	4,6	5	5,5	6,6	7,4	8,5	10,3	11,7	14,2	16,4

# Ordering Codes



## DN

Dimension,  $\varnothing$ DN:

100 mm, 125 mm, 140 mm, 150 mm, 160 mm, 180 mm, 200 mm, 225 mm, 250 mm, 280 mm, 315 mm, 355 mm, 400 mm, 450 mm, 500 mm, 560 mm, 630 mm

## A - Type of Activation

**B230** - 230V AC Belimo actuator

**B24** - 24V AC/DC Belimo actuator

**B24-W** - 24V AC/DC Belimo actuator & wire connector for supply and communication unit

**B24-SR** - 24V AC/DC Belimo actuator, modulated 0 V ... 10 V

## Example of the Ordering Code

S-RA1-630-B24-SR

Single compartment smoke control damper with nominal diameter 630 mm. Activated by a 24 V modulated Belimo actuator (0 V ... 10 V).

# Product Handling

## Warning

Some damper parts can have sharp edges. To prevent injuries, use gloves when you install or move the damper. If you use or operate the damper incorrectly, there is a risk of:

- electric shock.
- fire.
- other damage.

Ensure that installation is performed by a trained person. The S-RA1 is made of sheet metal. Be careful when you move the smoke control damper. It is necessary to move the bigger dampers with suitable lifting equipment (forklift, crane). Please follow both textual and graphic instructions.

### 1. Unpacking:

- Remove the packaging

### 2. Functionality check:

- Perform damper's functionality check (see "Operation Manual" section).

### 3. Placing the damper:

- Prepare the opening and/or duct connection surfaces as per the desired installation type.
- Carefully lift the smoke control damper with the forklift, crane or manually.
- Place the damper into the duct until the casings stop.

### 4. Fixing the damper:

**Note:** Make sure to continually check the alignment of the damper against the duct connection when performing the next steps.

- Fix the damper to the duct using suitable self-tapping screws through the duct installations in connection area.
- Verify there is no skewing of the damper body by measuring diagonally the nominal dimension.

### 5. Electrical connection:

- Check the wiring diagram of dampers activation mechanism and connect the damper accordingly to the on-site system and power supply.

### 6. Finishing:

- Clean the damper from the debris and excess material from the filling or insulation.
- Perform damper's functionality check (see "Operation Manual" section).
- Connect the continuous duct or mount the removed grille.
- Create and/or fill out the Operating Journal included with the smoke control damper (Operating Journal can be also downloaded at [design.systemair.com](http://design.systemair.com))



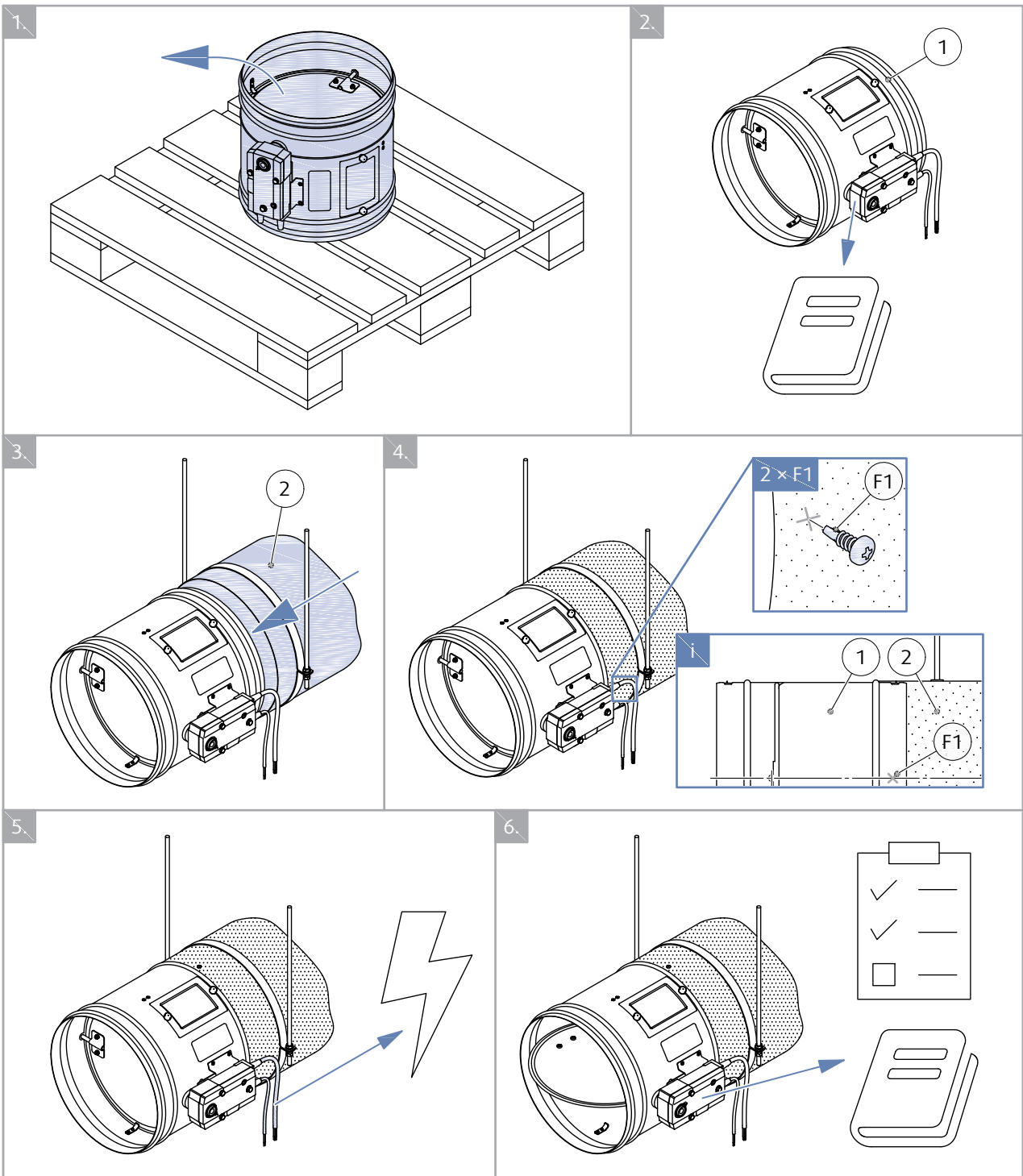









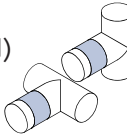

Legend for Product Handling

- 1 - Smoke control damper S-RA1
- 2 - Connected metal ductwork
- F1 - Screw M4×13 mm

# Installation Methods

 DMV	S-RA1	E <sub>600</sub> 120 (v <sub>ed</sub> i ↔ o) S1000 C <sub>MOD</sub> AAsingle	d) 	EN 1366-9	   
 D1V	DN 100 ... DN 630	E <sub>600</sub> 120 (v <sub>ed</sub> i ↔ o) S1000 C <sub>MOD</sub> AAsingle	d) 		   

## Notes:

**d)** - Duct per EN 1366-9

**v<sub>ed</sub>** - Duct placement, vertically oriented damper

## Installation Rules

- The duct connected to the smoke control damper must be supported or hung in such a way that the damper does not carry its weight. The damper must not support any part of the surrounding construction or wall which could cause damage and consequent damper failure.
- Easy access to mechanism and internal parts during inspection must be considered during damper placement.
- The minimum distance between the smoke control damper bodies installed in separate ducts must be 200 mm (refer to Standard EN 1366-2).
- The minimum distance between the smoke control damper and the wall or ceiling must be 75 mm.
- If the grilles are not original accessories, there must be a minimum clearance between the damper blade in its open position and self-standing grille. The clearance between the damper blade and these components must be 200 mm (refer to EN 1366-10).
- Lists of all permitted installation methods are provided in Handbook.

## Warning

- Make sure that only approved personnel performs the installation.
- Obey the written instructions and the illustrations in selected installation method.

# Installation DMV

## Vertically Oriented Damper, in the Metal Duct

The S-RA1 smoke control damper can be installed on these types of ductwork:

- "single" ductwork from sheet metal tested to EN 1366-9 or with higher density/thickness.
- builders work ducts (created on site).

This section does not give information about duct hanger rules. These rules are related to the weight of the duct and they must have static approval.

Hang the smoke control dampers from solid ceiling slabs with rods that have a thread. The dimension of these rods must be sufficient for the weight of the damper.

If you use anchors in the ceiling, make sure that you use a fire-rated anchor (with the correct fire rating certificate).



1. Prepare the duct connections:
  - a. Clean the ductwork connection surfaces.
  - b. Follow ductwork manufacturer instructions and if needed apply sealant on the ductwork connection surfaces.
2. Follow instructions in "Product Handling" section.
3. Perform damper's functionality check (see "Operation Manual" section).

### CAUTION:

- Make sure that the closest hanger is placed not further than 150 mm from the duct connection.
- If the hanger system is longer than 1,5 m, fire-resistant insulation is necessary (see hanger manufacturer instruction).
- Make sure that it is always possible to access the smoke control damper internally for maintenance. If necessary, make inspection panel in the connecting duct.
- Duct with lower resistivities will decrease the fire resistivity of smoke control damper.
- The maximum fire resistance for in-duct installation is EI120 with pressure level 2 (-1000 Pa ... 300 Pa).

### Installation Distances

The minimum distance between the damper body and the wall or ceiling must be 75 mm (refer to Standard EN 1366-2). The minimum distance between two damper bodies installed in separate ducts must be 200 mm.

 DMV	S-RA1 DN 100 ... DN 630	$E_{600} 120 (v_{ed} i \leftrightarrow o)$ S1000 $C_{MOD}$ AAsingle	d) 	EN 1366-9	
--	----------------------------	--	---	-----------	---

### Notes:

d) - Duct per EN 1366-9

$v_{ed}$  - Duct placement, vertically oriented damper

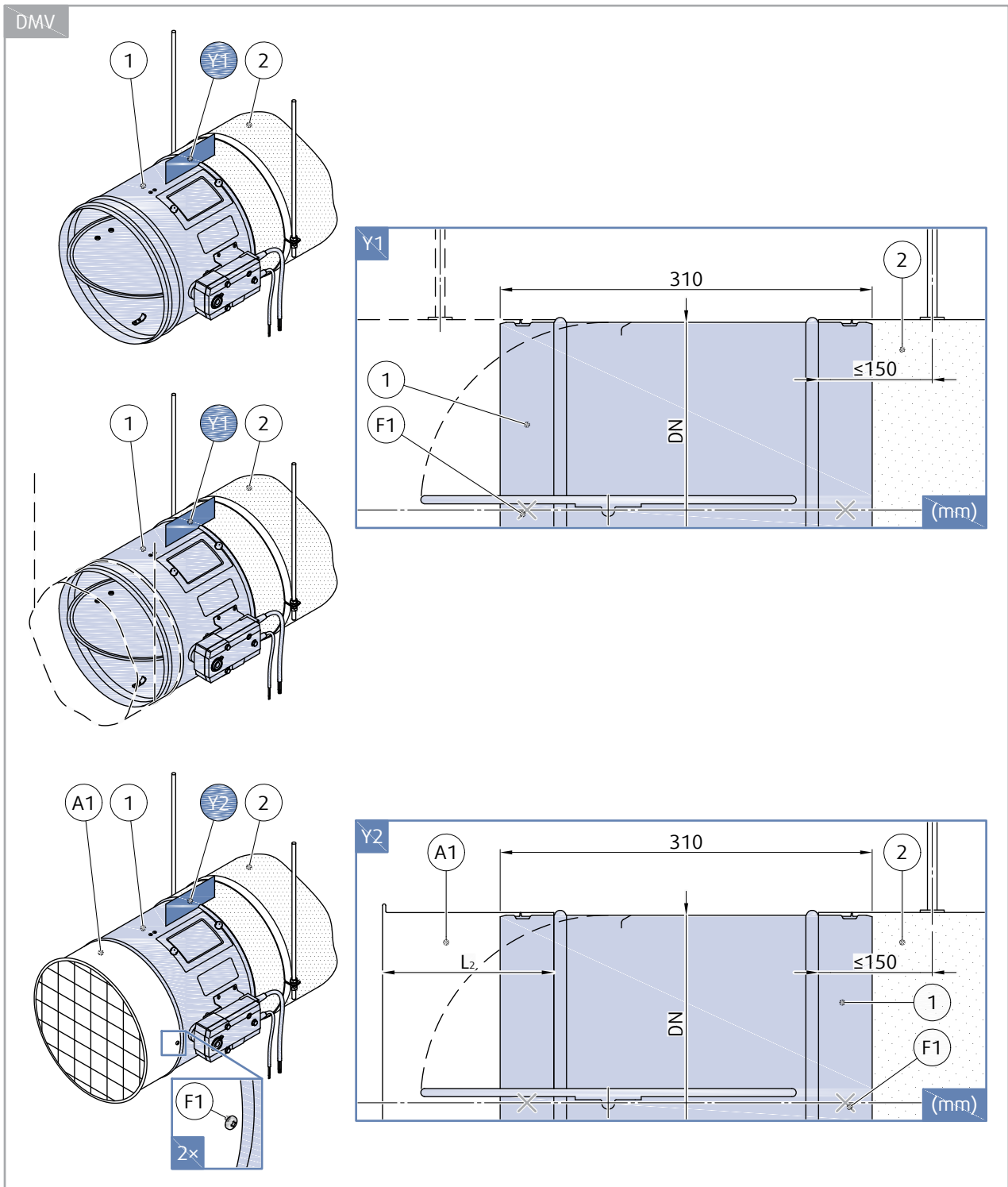

#### Legend for installation DMV:

- 1 - Smoke control damper S-RA1
- 2 - Connected metal ductwork
- A1 - Extension with grille (GE1-S-RA1), sold separately
- F1 - Screw M4×13 mm
- Y1, Y2 - Cutting planes

# Installation D1V

## Vertically Oriented Damper, on the Duct

The S-RA1 smoke control damper can be installed on these types of ductwork:

- "single" ductwork from sheet metal tested to EN 1366-9 or with higher density/thickness.
- builders work ducts (created on site).

This section does not give information about duct hanger rules. These rules are related to the weight of the duct and they must have static approval.

Hang the smoke control dampers from solid ceiling slabs with rods that have a thread. The dimension of these rods must be sufficient for the weight of the damper.

If you use anchors in the ceiling, make sure that you use a fire-rated anchor (with the correct fire rating certificate).

1. Prepare the duct connections:



- a. Clean the ductwork connection surfaces.
  - b. Follow ductwork manufacturer instructions and if needed apply sealant on the ductwork connection surfaces.
2. Follow instructions in "Product Handling" section.
  3. Perform damper's functionality check (see "Operation Manual" section).

### CAUTION:

- Make sure that the closest hanger is placed not further than 150 mm from the duct connection.
- If the hanger system is longer than 1,5 m, fire-resistant insulation is necessary (see hanger manufacturer instruction).
- Make sure that it is always possible to access the smoke control damper internally for maintenance. If necessary, make inspection panel in the connecting duct.
- Duct with lower resistivities will decrease the fire resistivity of smoke control damper.
- The maximum fire resistance for in-duct installation is EI120 with pressure level 2 (-1000 Pa ... 300 Pa).

### Installation Distances

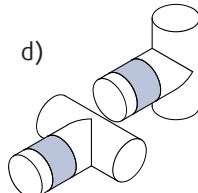
The minimum distance between the damper body and the wall or ceiling must be 75 mm (refer to Standard EN 1366-2). The minimum distance between two damper bodies installed in separate ducts must be 200 mm.

 <p>S-RA1 DN 100 ... DN 630 D1V</p>	<p>S-RA1 DN 100 ... DN 630</p>	<p><math>E_{600} 120 (v_{ed} i \leftrightarrow o)</math> <math>S1000 C_{MOD} AAsingle</math></p>	<p>d)</p> 	<p>EN 1366-9</p>	
--	------------------------------------	--	---	------------------	---

### Notes:

**d)** - Duct per EN 1366-9

**v<sub>ed</sub>** - Duct placement, vertically oriented damper

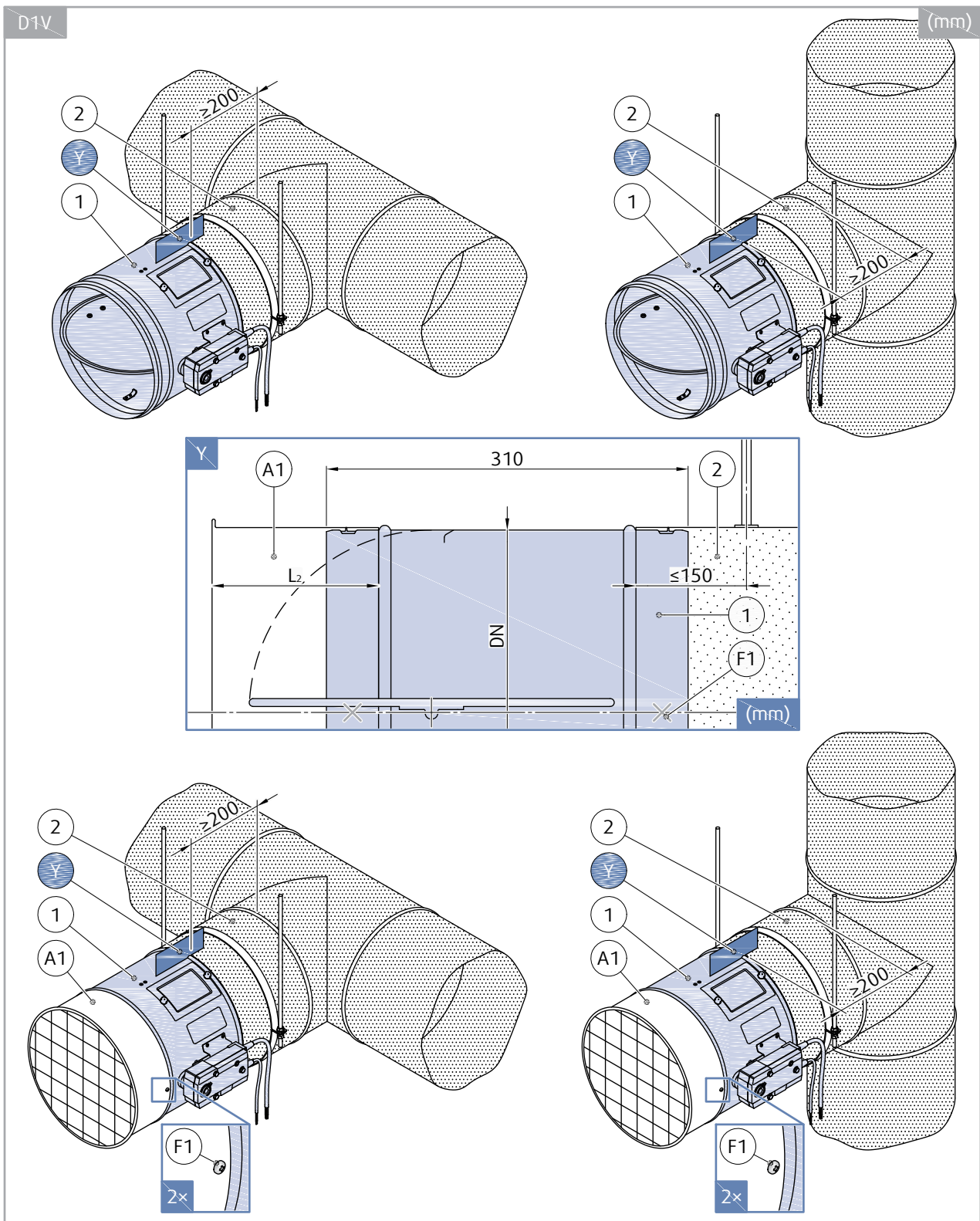

#### Legend for installation D1V:

- 1 - Smoke control damper S-RA1
- 2 - Connected metal ductwork
- A1 - Extension with grille (GE1-S-RA1), sold separately
- F1 - Screw M4×13 mm
- Y - Cutting plane

# Electrical Connections

## WARNING

- Risk of electric shock.
- Stop the power supply before you do work on electrical equipment.
- Only approved electricians can do work on the electrical system.

To access the electrical parts of this product follow instructions in "Product Handling" section.

## Electrical Parameters for Type of Activation and Actuator

T   NVF   PC   A	DN (mm)																
	100	125	140	150	160	180	200	225	250	280	315	355	400	450	500	560	630
S-RA1	B230   AC 230 V, 50/60 Hz   7 VA   BEN230 B24   AC (50/60 Hz)   DC 24 V   6 VA   BEN24 B24-W   AC (50/60 Hz)   DC 24 V   6 VA   BEN24-ST B24-SR   AC (50/60 Hz)   DC 24 V   6,5 VA   BEN24-SR																

### Notes:

**T | NVF | PC | A** - Activation Type | Nominal Voltage and Frequency | Power Consumption for wire sizing | Actuator

### Type of Activation B230

- The circuit switch between wires 2 and 3 is not part of the damper supply.
- When the power supply is connected to wires 1 and 3, the actuator moves to the OPEN position.
- When the power supply is connected to wires 1 and 2, the actuator moves to the CLOSED position.

AC 230 V

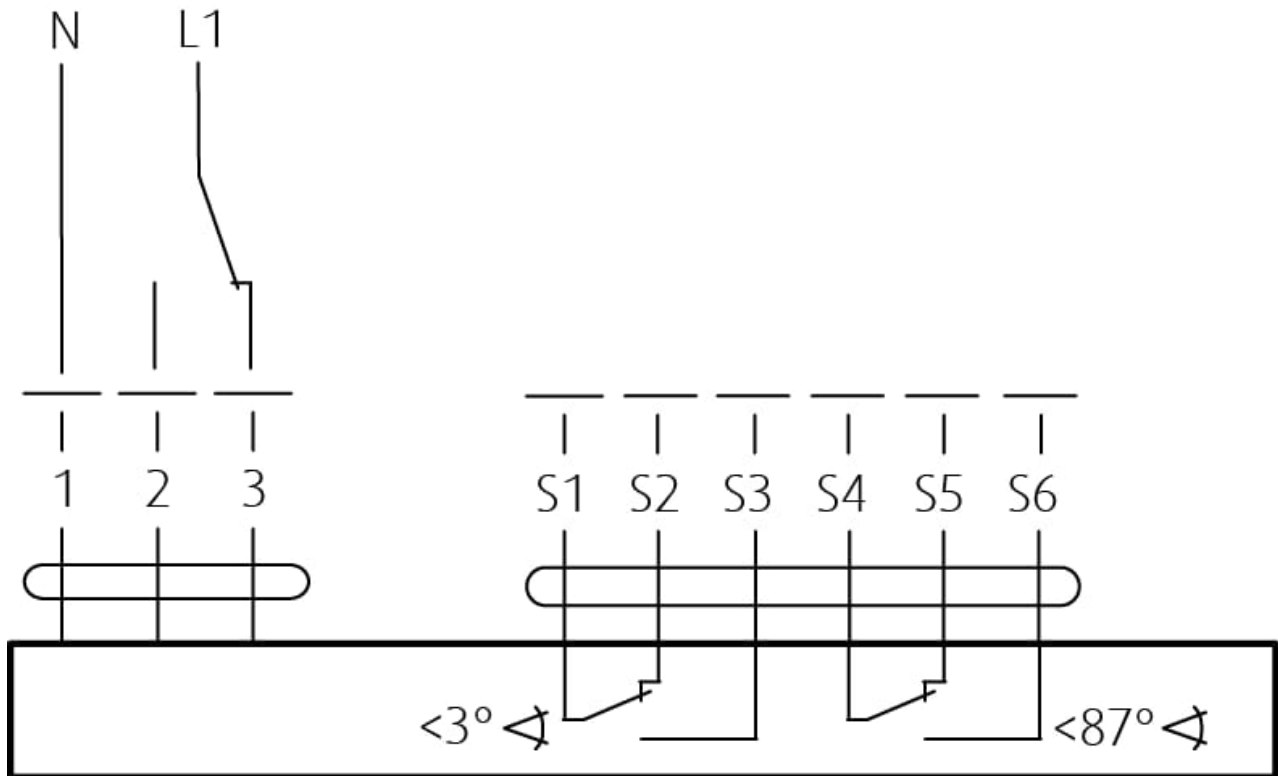

#### Notes:

- **CAUTION:** Main power supply voltage!
- Parallel connection of more actuators possible when the power consumption and switching threshold is observed!

#### Legend for Activation Type B230

- 1 - blue
- 2 - brown
- 3 - white
- S1 - violet
- S2 - red
- S3 - white
- S4 - orange
- S5 - pink
- S6 - grey

The Belimo BE230 actuator has wires without colours.



### Type of Activation B24

- The circuit switch between wires 2 and 3 is not part of the damper supply.
- When the power supply is connected to wires 1 and 3, the actuator moves to the OPEN position.
- When the power supply is connected to wires 1 and 2, the actuator moves to the CLOSED position.

AC/DC 24 V

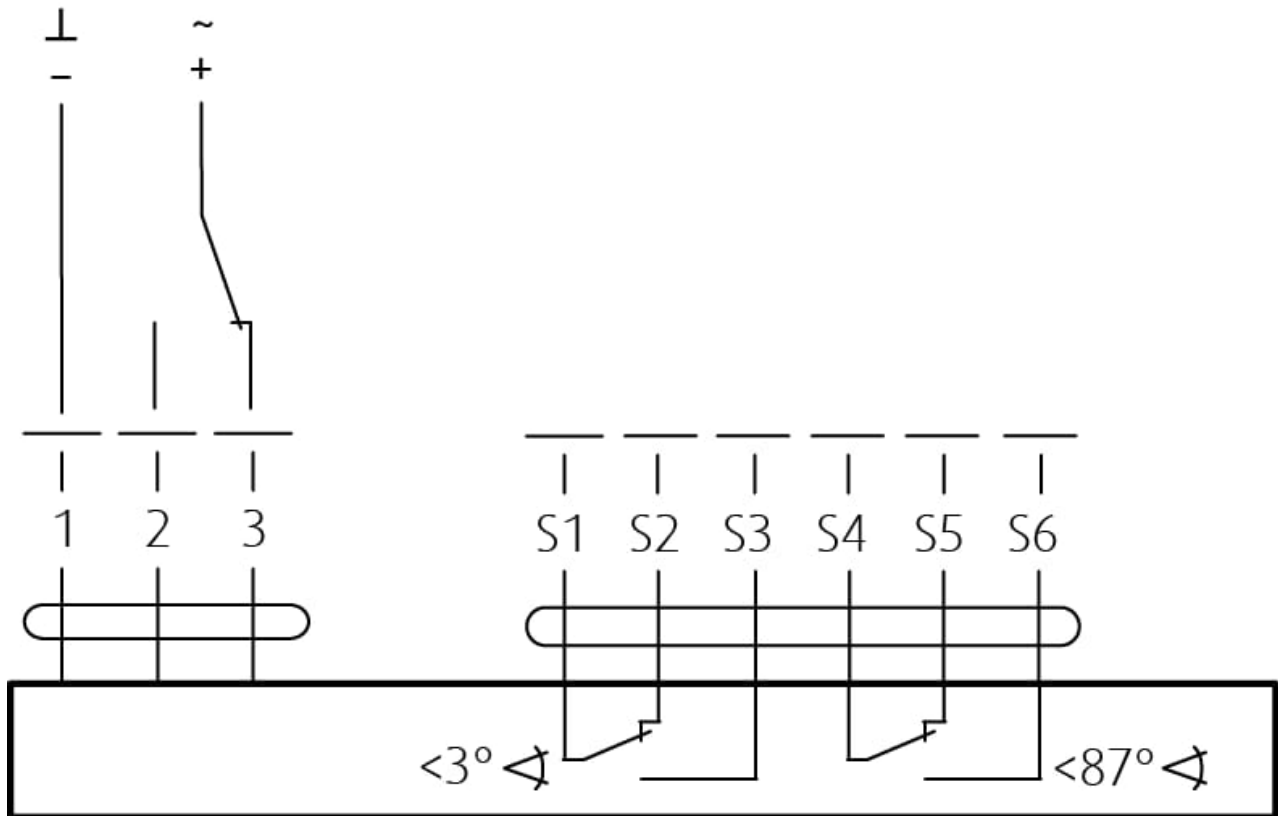

#### Notes:

- **CAUTION:** Main power supply voltage!
- Parallel connection of more actuators possible when the power consumption and switching threshold is observed!

#### Legend for Activation Type B24

- 1 - black
- 2 - red
- 3 - white
- S1 - violet
- S2 - red
- S3 - white
- S4 - orange
- S5 - pink
- S6 - grey

The Belimo BE24 actuator has wires without colours.

### Type of Activation B24-W

This type of activation has cable connectors for the supply and communication unit (the communication unit is not part of the mechanism).

- The circuit switch between wires 2 and 3 is not part of the damper supply.
- When the power supply is connected to wires 1 and 3, the actuator moves to the OPEN position.
- When the power supply is connected to wires 1 and 2, the actuator moves to the CLOSED position.

AC/DC 24 V

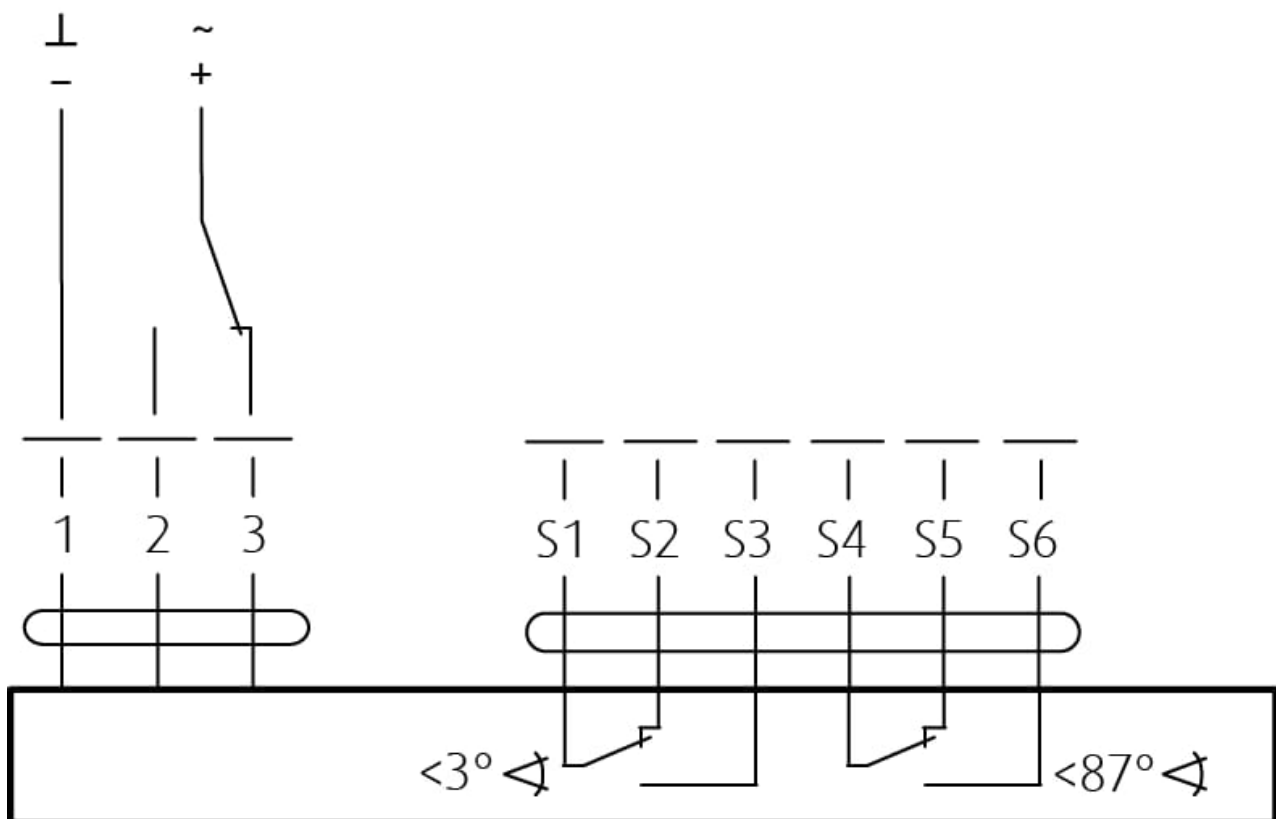

#### Notes:

- **CAUTION:** Main power supply voltage!
- Parallel connection of more actuators possible when the power consumption and switching threshold is observed!
- Combination of power supply voltage and safety extra-low voltage not permitted at the both auxiliary switches.

#### Legend for Activation Type B24-W

The actuator has connection plugs.

Supply: With a 3-pole plug that is applicable, for example, for BKNE230-24

Auxiliary switch: With a 6-pole plug that is applicable, for example, for BKNE230-24

### Type of Activation B24-SR

24V AC/DC Belimo Actuator, modulated (0)2..10V

- When power supply is connected to wires 1 and 3, actuator drives to position OPEN.
- When power supply is connected to wires 1 and 2, actuator drives to position CLOSED.

## AC/DC 24 V

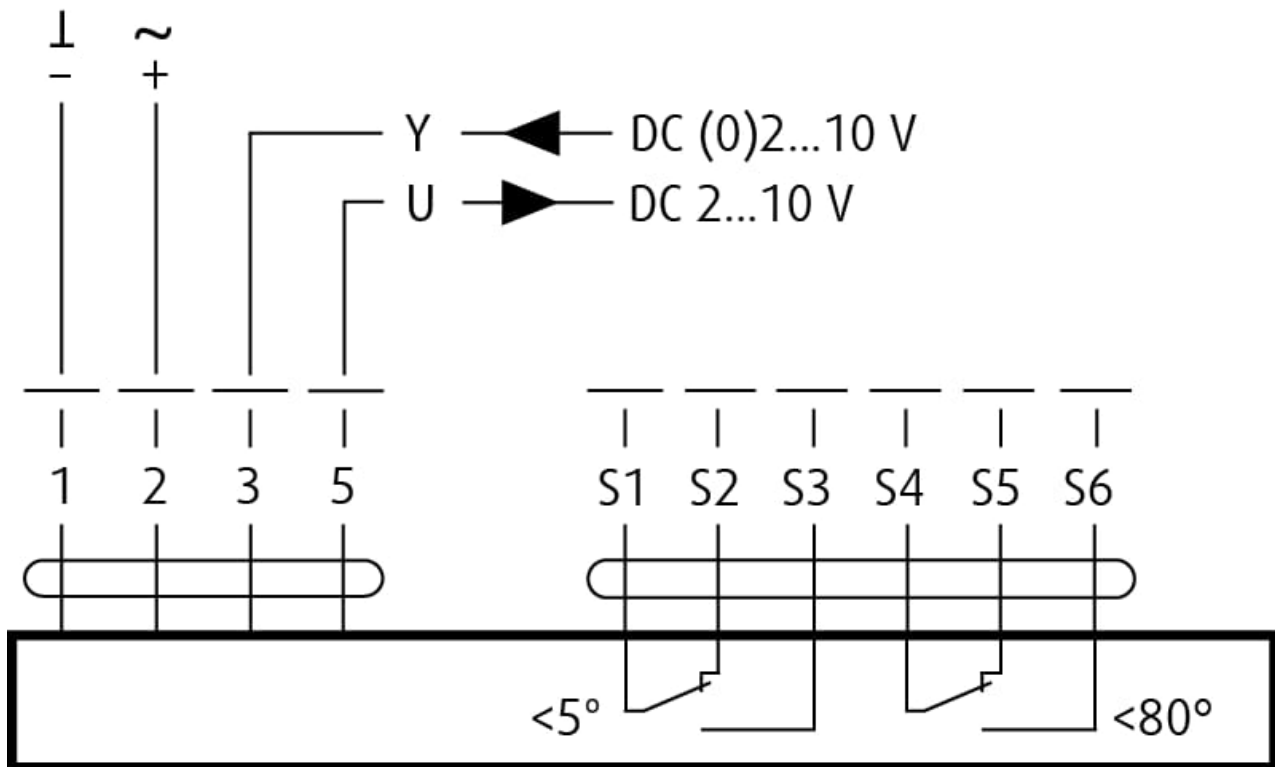

#### Notes:

- **CAUTION:** Main power supply voltage!
- Parallel connection of more actuators possible when the power consumption and switching threshold is observed!
- Operating range Y - **DC (0)2...10 V**
- Input Impedance - **100 k $\Omega$**
- Position feedback U - **DC 2...10 V**
- Position feedback U note - **Max. 0.5 mA**
- Position accuracy -  **$\pm 5\%$**

#### Legend for Activation Type B24-SR

- 1 - black
- 2 - red
- 3 - white
- 5 - orange
- S1 - violet
- S2 - red
- S3 - white
- S4 - orange
- S5 - pink
- S6 - grey

The Belimo BE24 actuator not available in SR configuration.

# Operation Manual

## Functionality Check

After you install the damper, make sure that you set it to its “closed” operating position. If you use the damper to remove pollutants, make sure that you set it to its “open” operating position. Connect the actuator to the related electric power supply (refer to the “Electrical connections” section). This procedure starts the actuator and sets the damper to its operating position.

### How to set the damper to the “open” position:

- The blade must move to the fully open position in 60 seconds or less. Then, the blade must stay locked.
- After the blade is in its end position, the related signaling circuit sets to on. Make sure that wires S1 and S2 are connected.

### How to set the damper to the “closed” position:

- The blade must move to the fully closed position in 60 seconds or less.
- After the blade is in its end position, the related signaling circuit sets to on. Make sure that wires S4 and S6 are connected.

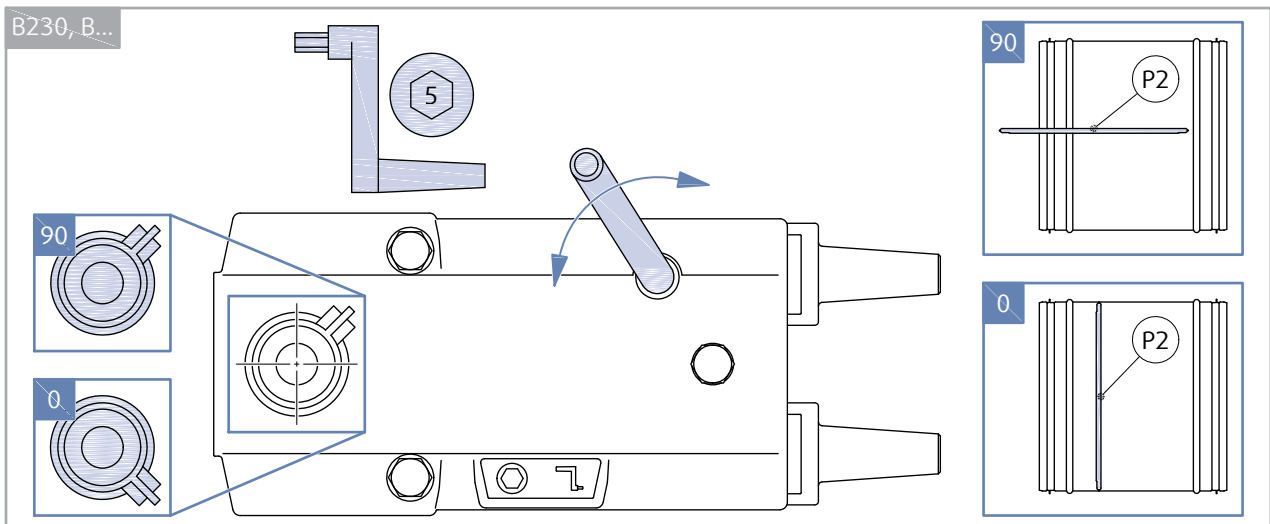

## Damper Inspection

**CAUTION:** Never perform inspection when there is air flowing in the duct connected to the smoke control damper.

**Do not change the dampers or their structure without the approval of the manufacturer.**

The actuator keeps the dampers on stand-by during their life cycle. The operator obeys the applicable regulations and standards to do regular checks of the dampers. The recommended minimum interval for the inspection checks is 6 months. The manufacturer and/or government authorities must approve the inspecting person and/or process for this inspection. Operating Journal must be kept during the lifecycle of the smoke control damper. The damper's Operating Journal includes a copy of the approval/s of the inspecting person. If the inspecting person finds differences, the operator must write these differences in the Operating Journal. Then, he must recommend action to remove these differences.

After you install and start the damper, immediately do an initial check. This check obeys the same conditions as the six-month inspections.

Do a check of these elements of the external side of the damper:

- The damper housing
- The actuator movement.

**Note:**

To do a visual check of the internal parts of the damper, dismount the inspection lid or the grille. This will give you access to the internal parts. Also, if the damper has an mechanism lid, you can open the lid to access the internal parts.

Do a check of these items of the internal side of the damper:

- Make sure that there are no foreign objects or layers of contamination in the air distribution systems of the damper.
- The internal casing of the damper
- The sealings
- The foaming material
- The condition of the damper blade
- How accurately the damper blade closes when it is against the backstop in the closed position.

### Recommended Procedure for the Inspection Log (refer to EN 12101)

1. Find the identification of the damper.
2. Write the date of the inspection.
3. Examine the actuator wiring for damage.
4. Examine the wiring of the end switches for damage.
5. Make sure that the damper is clean. If necessary, clean the damper.
6. Do a check of the inspection lid and of the tightness of the cover.
7. Do a check of the blade and of the sealings. If necessary, correct the defects and record the results (where applicable).
8. Do a functional test of the damper (open and close) (refer to the "Smoke Damper Functionality Check" chapter).
9. Confirm the operation of the damper with the control system:
  - a. Monitor the physical performance of the damper
  - b. Monitor the signals of the end positions.
  - c. If necessary, correct and record the defect (where applicable).
10. The damper is part of the SHEVS (Smoke and Heat Exhaust Ventilation System). Thus, you must do a check of the full system (refer to the Operational and Maintenance Requirements).
11. Set the system to the operating position (refer to the "Operation Manual").
12. Record the result in the "Operating Journal" with the name and the signature of the Inspection Technician.

After the inspection, the inspecting person must write the data that follows in the "Operating Journal":

- Condition of the damper
- Date of the inspection
- Name, Surname and Signature of the employee that did the inspection (make sure that you can read this data).

## Supplement

If you find differences from the terms and the technical specifications that are in this manual, speak to the manufacturer. We reserve the right to make changes to the product without notice.

