

# Geniox Core Control system 44.04.02 (230V Pre-heat)

Documents listed on pages below:

Project cover sheet: page 1

Quick Guide: page 2

General Description: page 3-4

External connections: page 10-17

Circuit Diagram: page 19-26

Modbus Guide: page 21

Modbus address list: page 26

Cable plan: page 100-116

Units with internal cabinet:

Cabinet is always inside the unit.

AHU unit data.

Heat exchanger type:

See data in the attached annex - Technical data

Heat coil type:

See data in the attached annex - Technical data

Cooling coil type:

See data in the attached annex - Technical data

Electrical data:

Total consumed power:

Watch printed order

Fan fuse size:

Watch printed order

Supply air fan cable resistance:

Watch printed order

Extract air fan cable resistance:

Watch printed order

Max pre-fuse:

Watch printed order

Ik max on fuse in unit:

6 kA

Manufacturer:

Systemair A/S, Denmark

Ved Milepælen 7

8361 Hasselager



Geniox  
Access CU27 Controller

Frontpage

Project:

Geniox-Core CS 44.04.02 230V Pre-heat GB

Rev.:

44.04.02

Sheet:

1

Date:

07-08-2020

initials:

MIKE

Total sheets:

4

Next sheet:

2

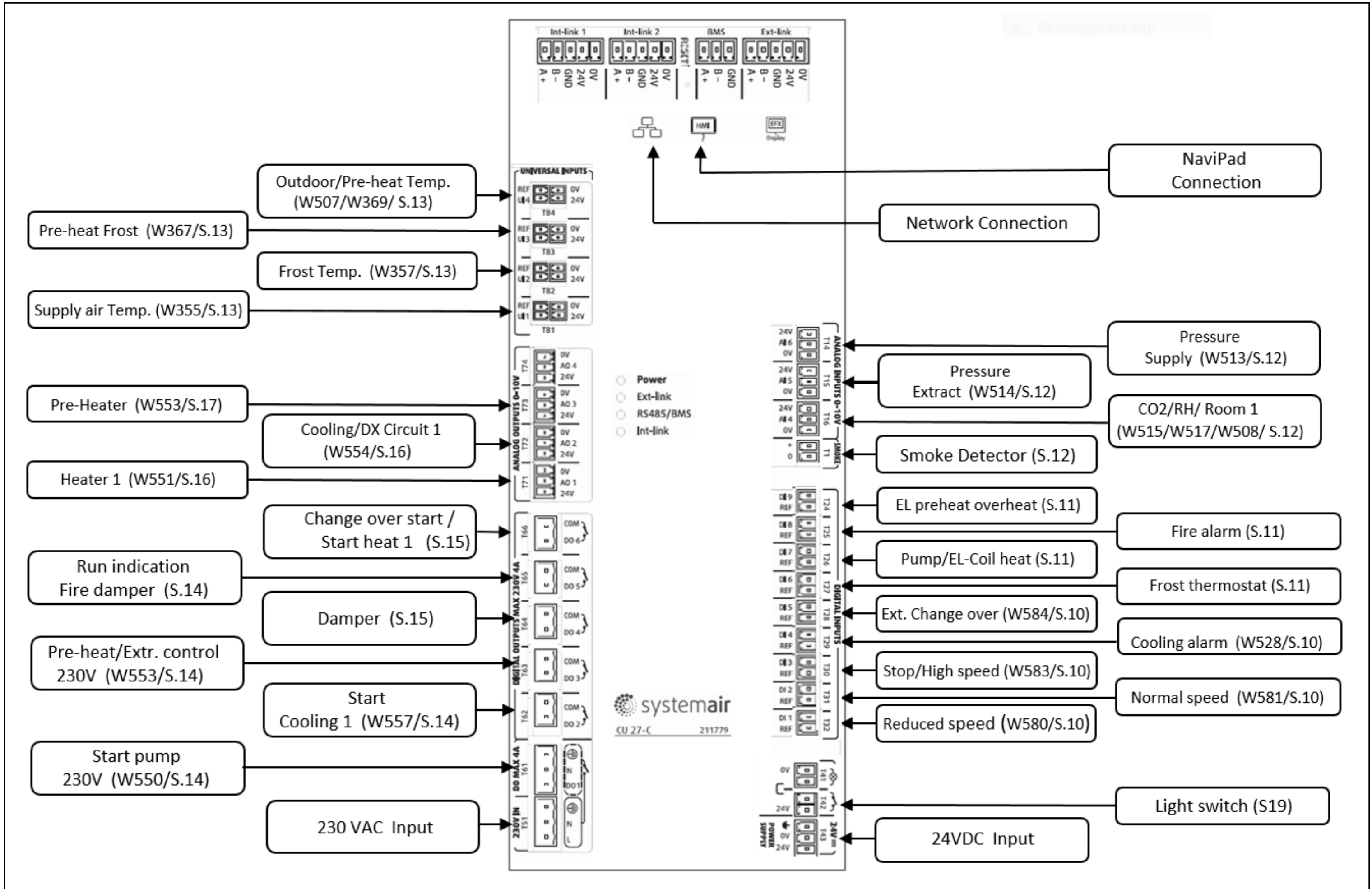

Symbols are according to IEC 60617.  
 On the following 2 pages there are descriptions of used symbols in the project.

Wire Colour code	
Black	- BK
Brown	- BN
Red	- RD
Orange	- OG
Yellow	- YE
Green	- GN
Blue	- BU
Violet	- VT
Gray	- GY
White	- WH
Pink	- PK
Transparent	- TP
Green/Yellow	- PE

L1:1 > References

-X2:1 Terminal

-EA Lamp

-SF Switchgear

-BP Pressure transmitter

-BP Pressure Switch

-F Automatic tripping,

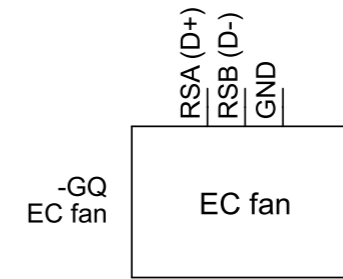

EBM EC fan

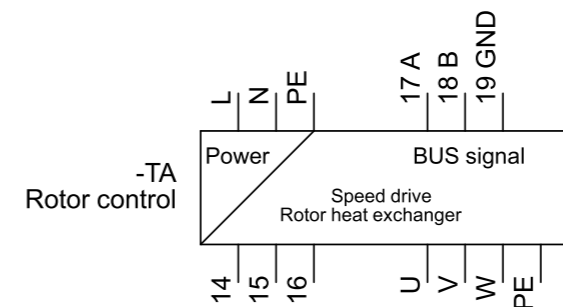

Rotary heat exchanger

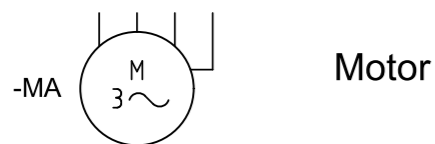

Motor

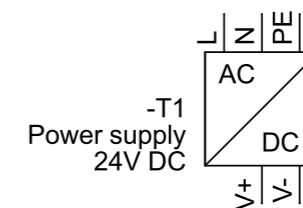

Power supply

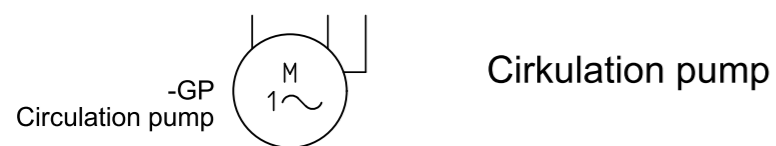

Cirkulation pump

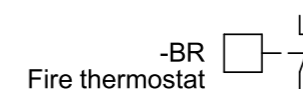

fireguard

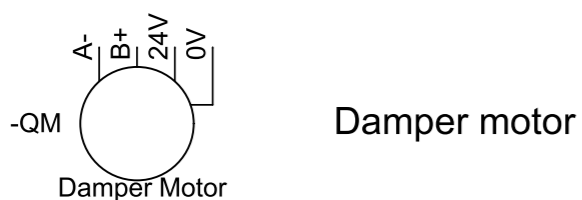

Damper motor

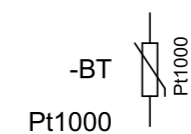

Temperature (measuring)

Labeling of wires are marked with terminal name

Components are marked with component codes followed by a number according to IEC 61346-1 Chart 1

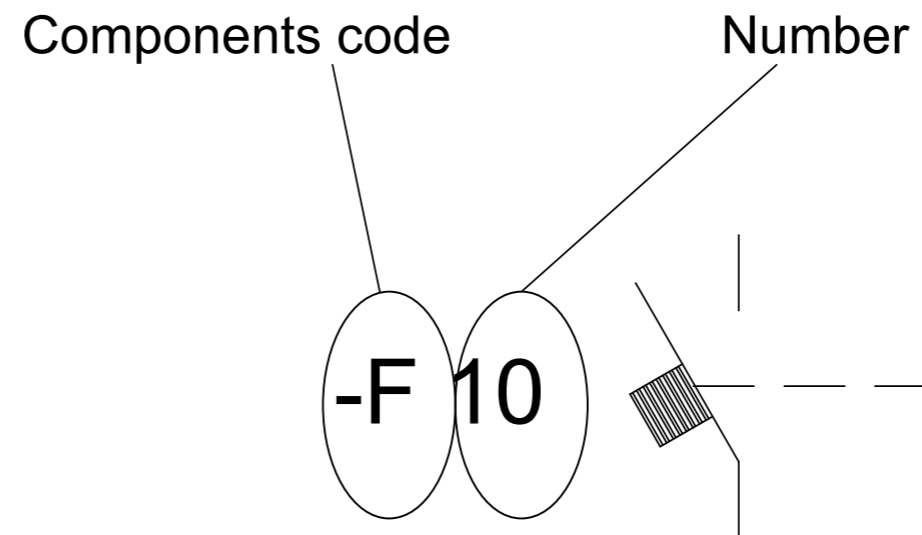
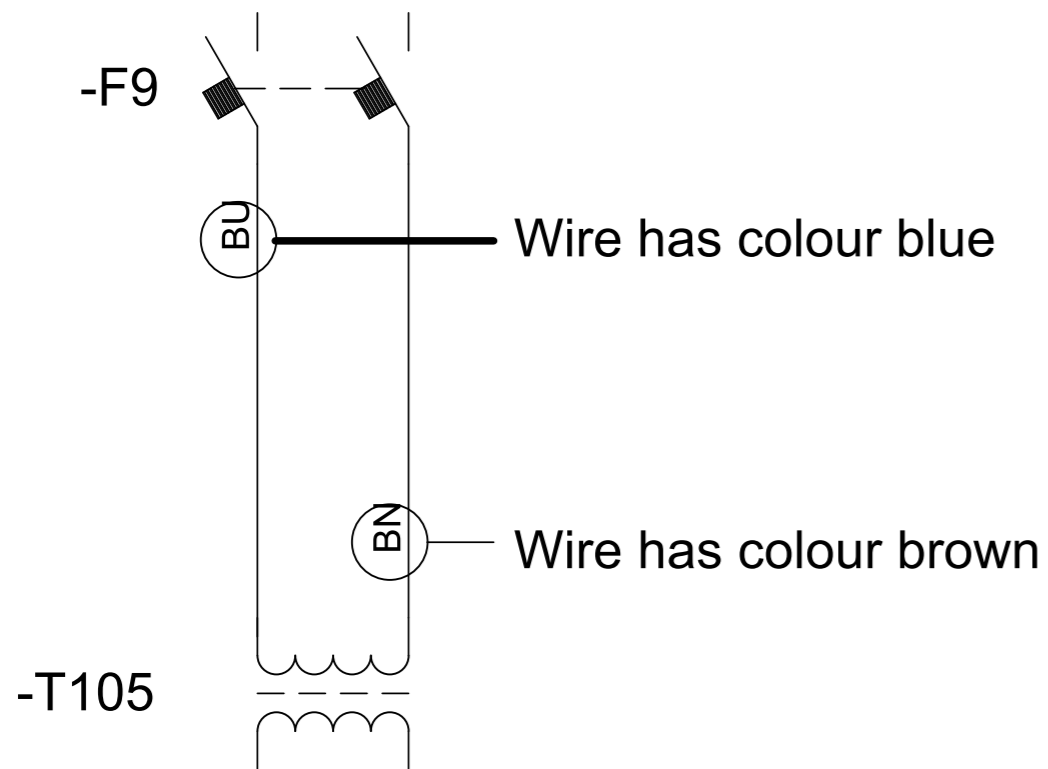

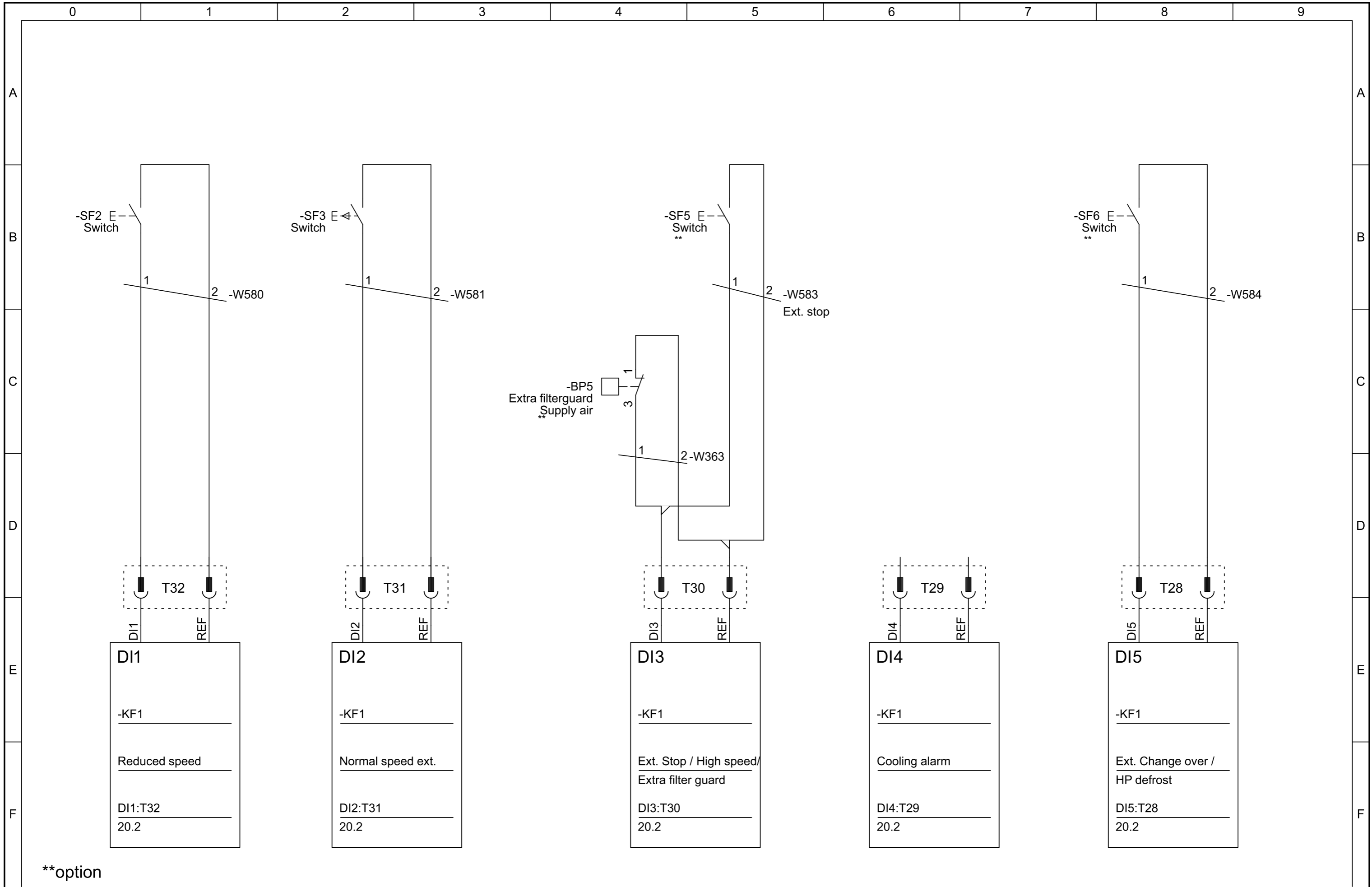

\*\*option

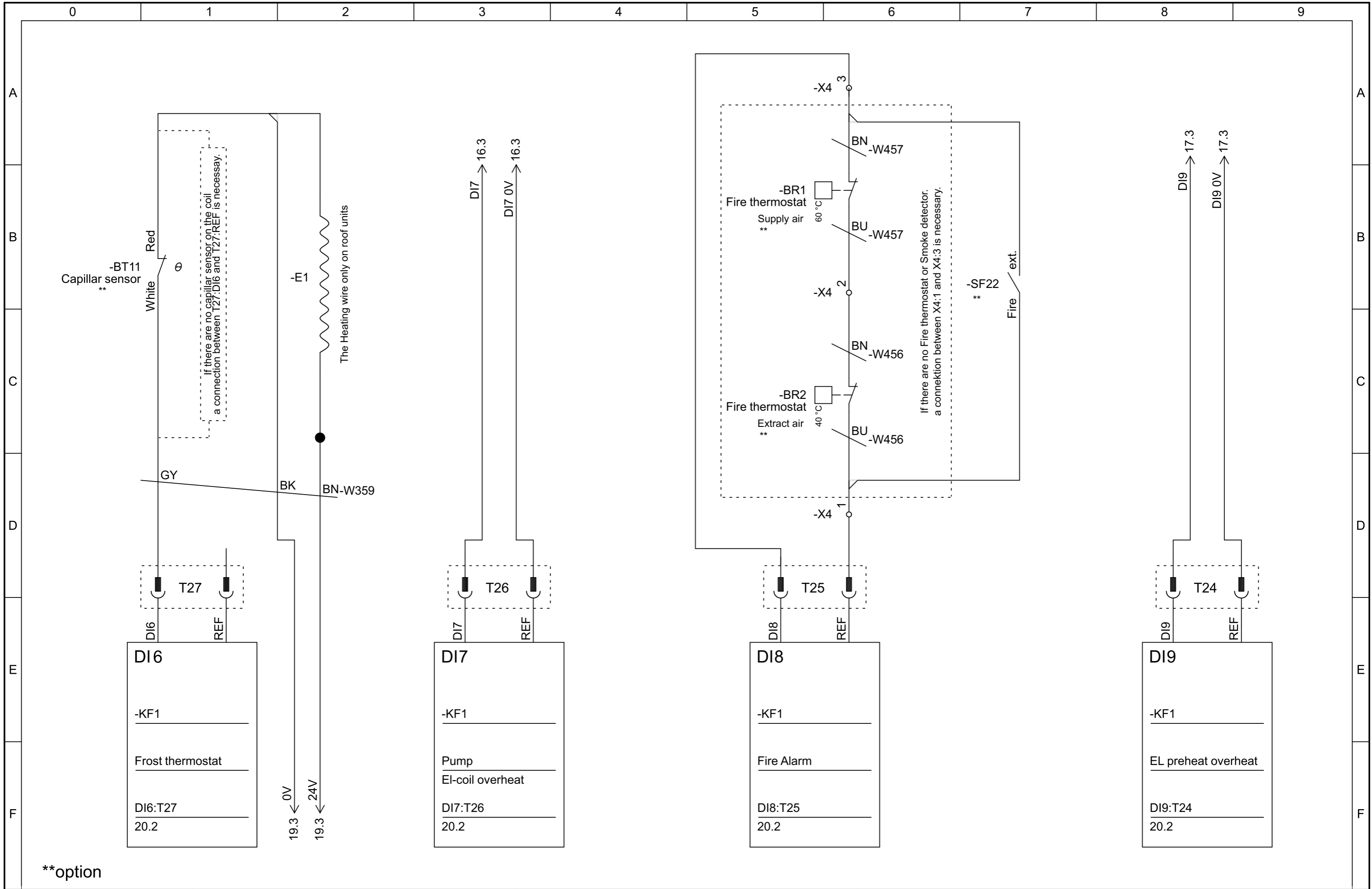

\*\*option

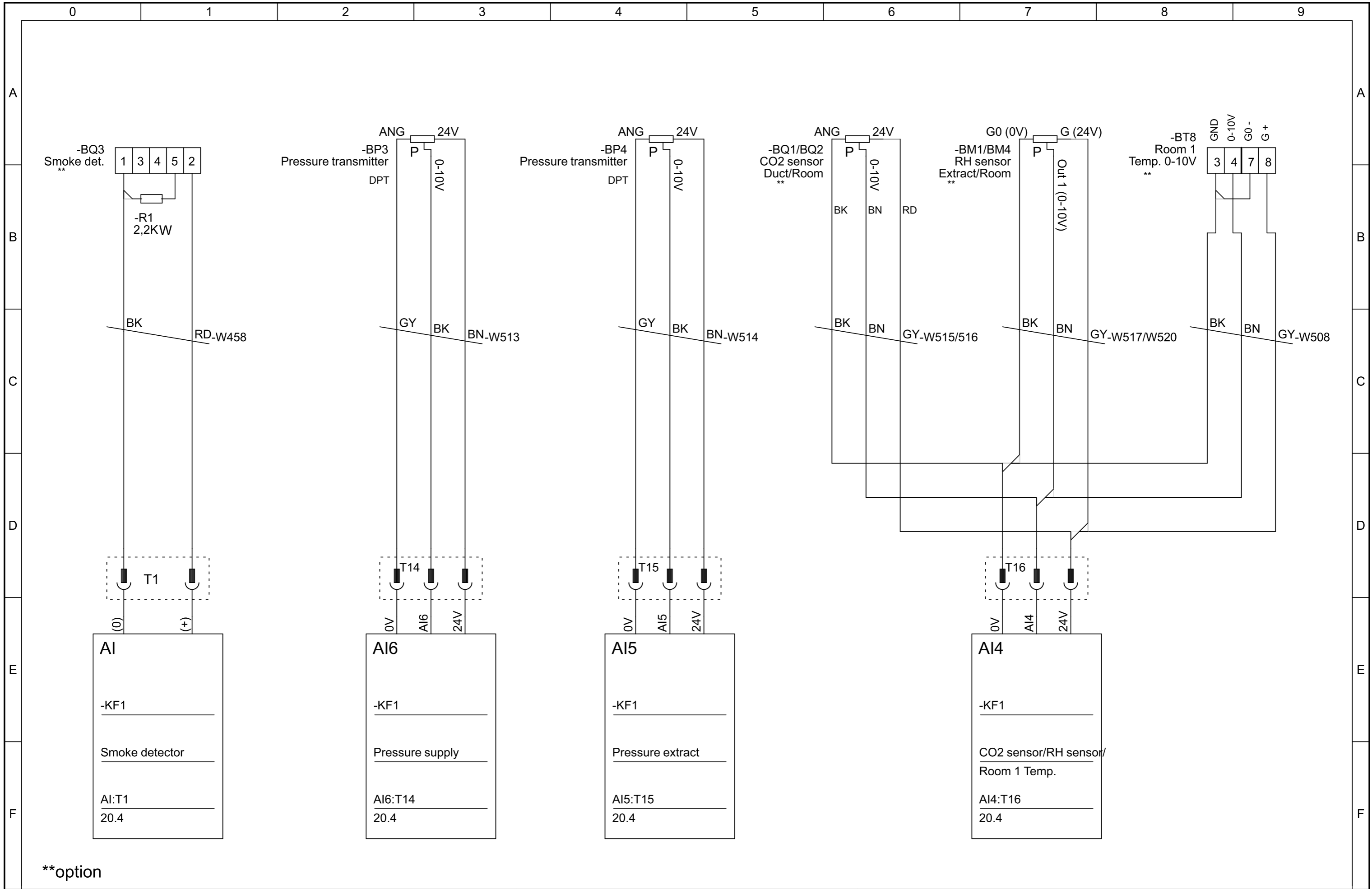

\*\*option

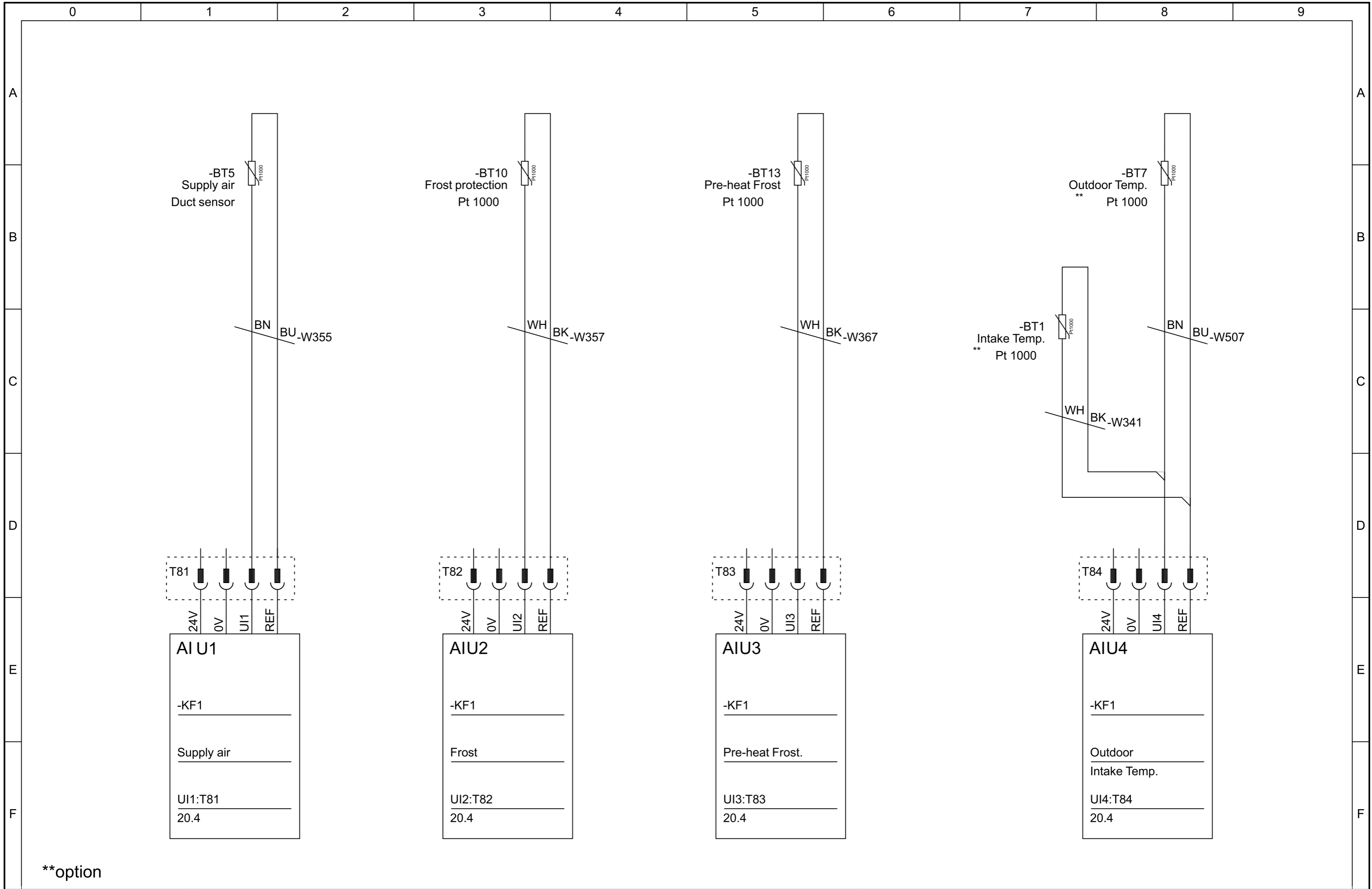

\*\*option



Geniox  
Access CU27 Controller

External connections UI

Project:

Geniox-Core CS 44.04.02 230V Pre-heat GB

Rev.:

44.04.02

Sheet:

13

Date:

06-11-2019

initials:

MIKE

Total sheets:

17

Next sheet:

14



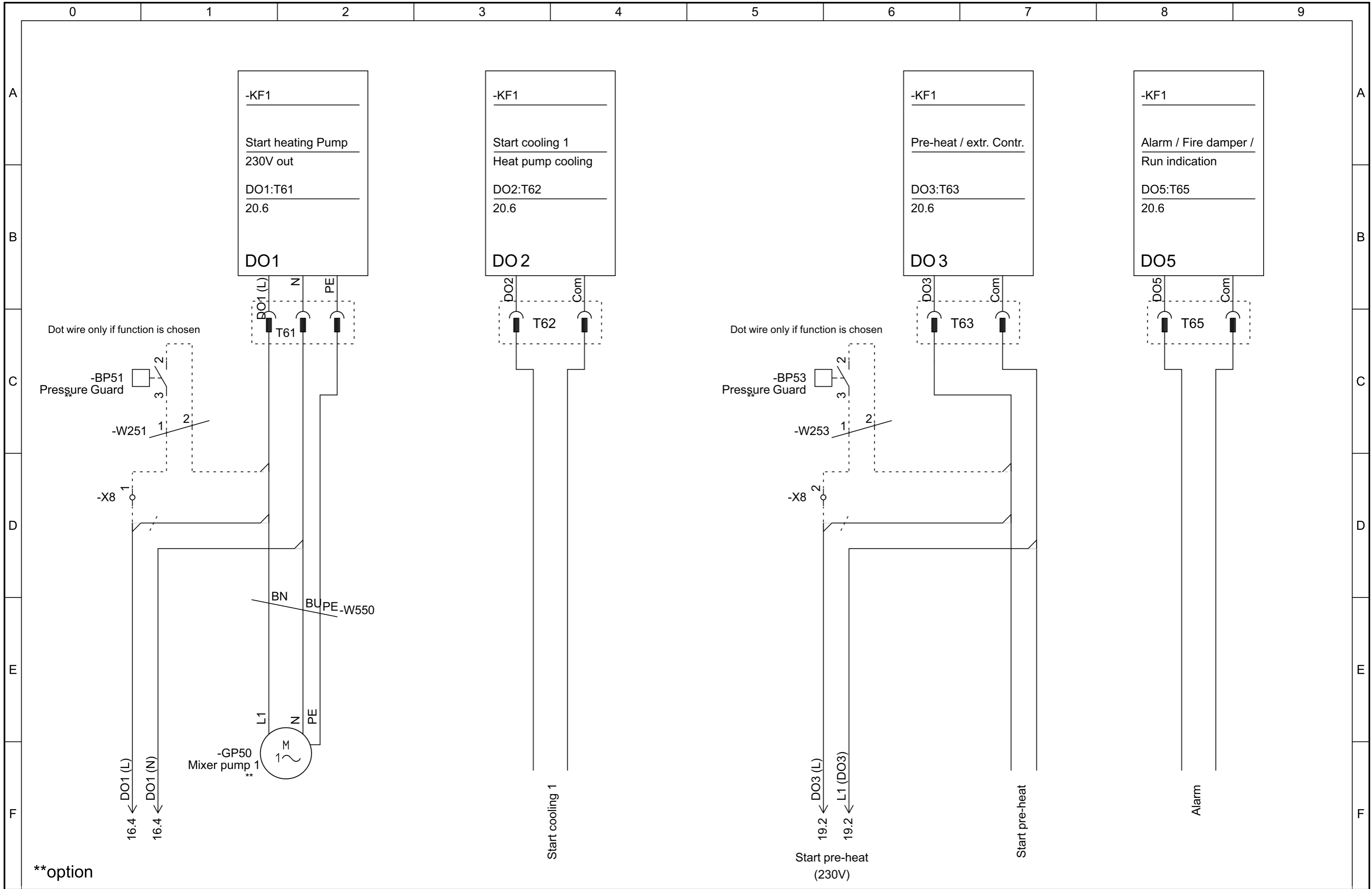

\*\*option

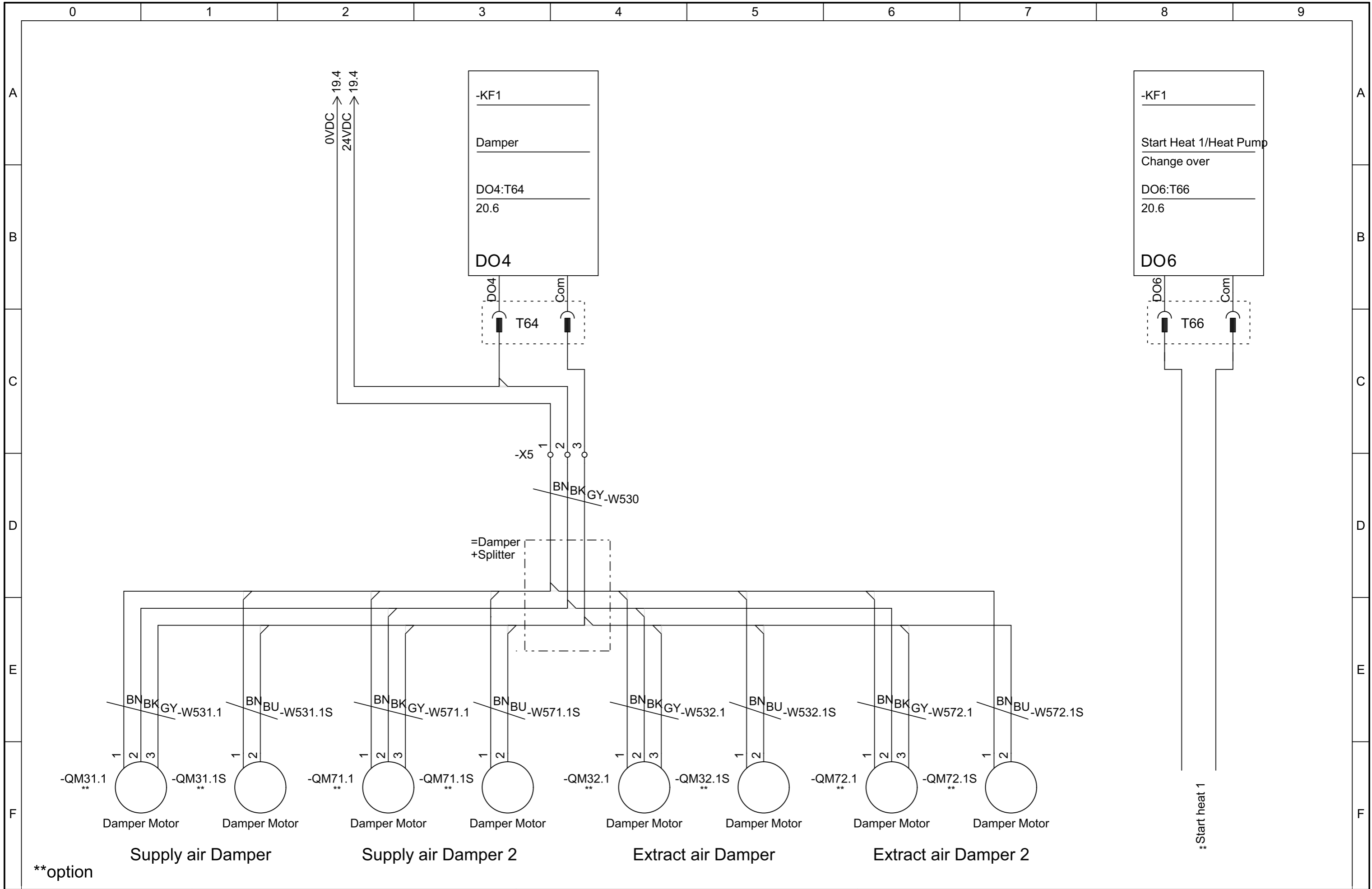

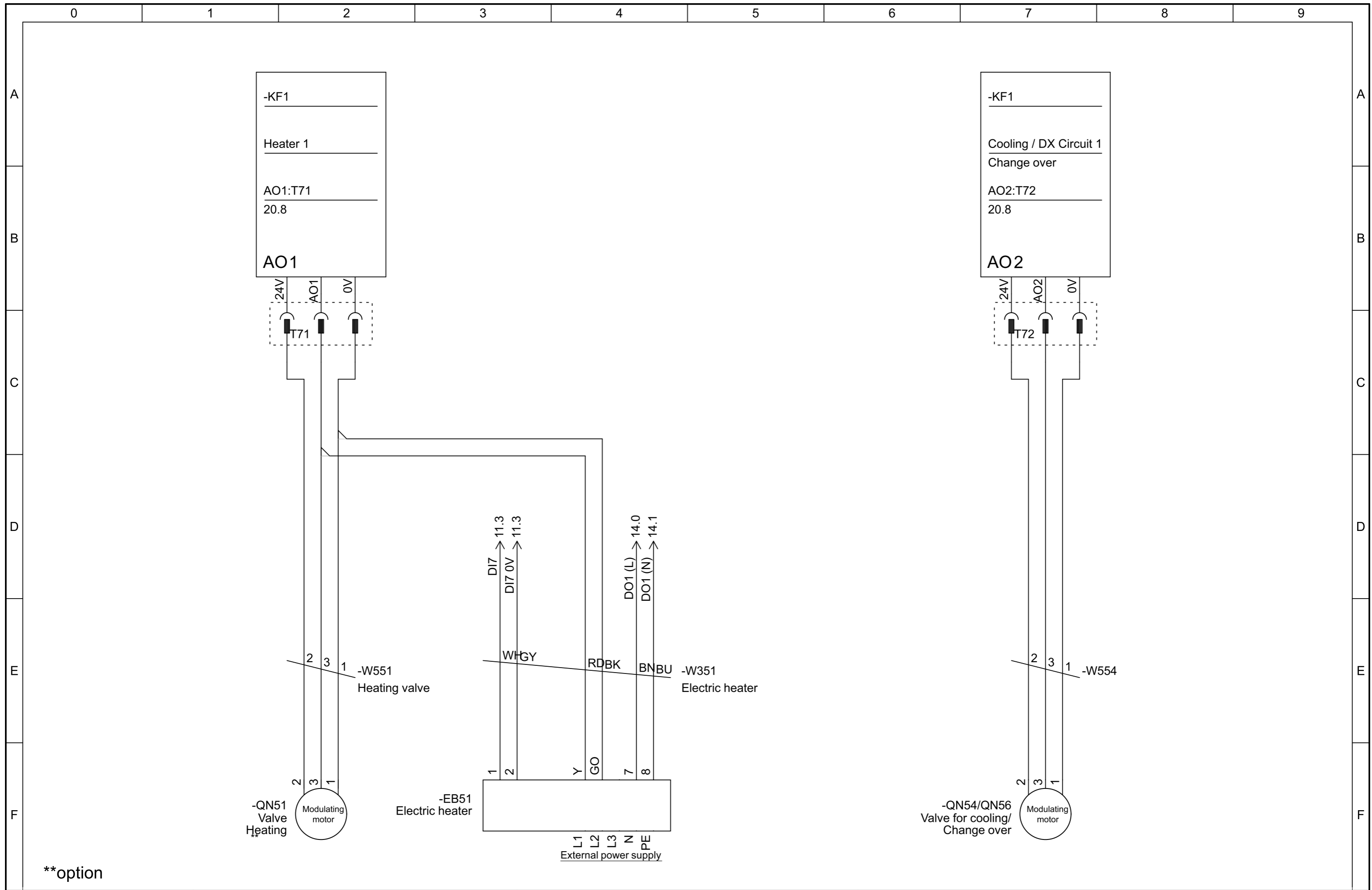

\*\*option

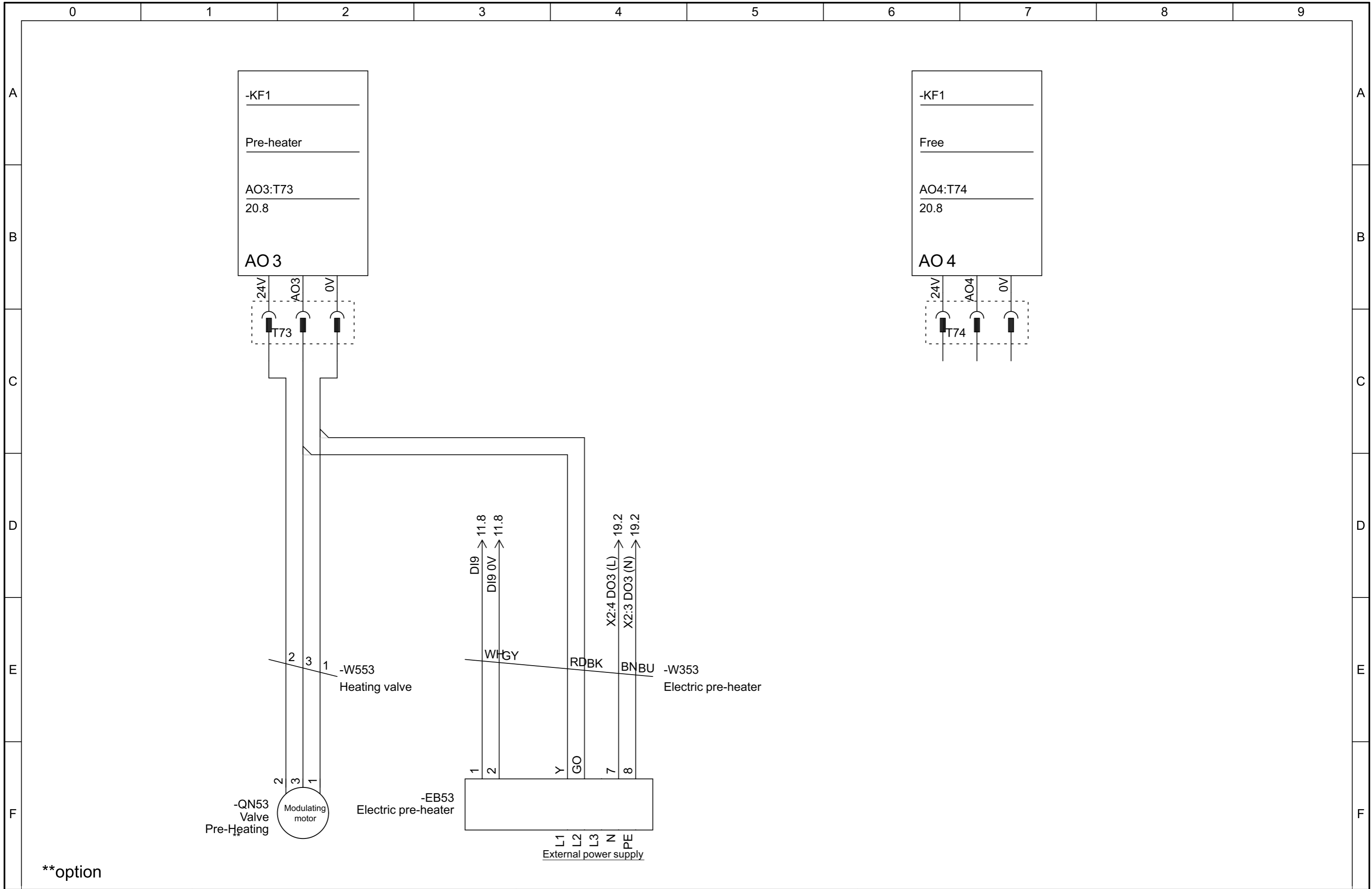

\*\*option

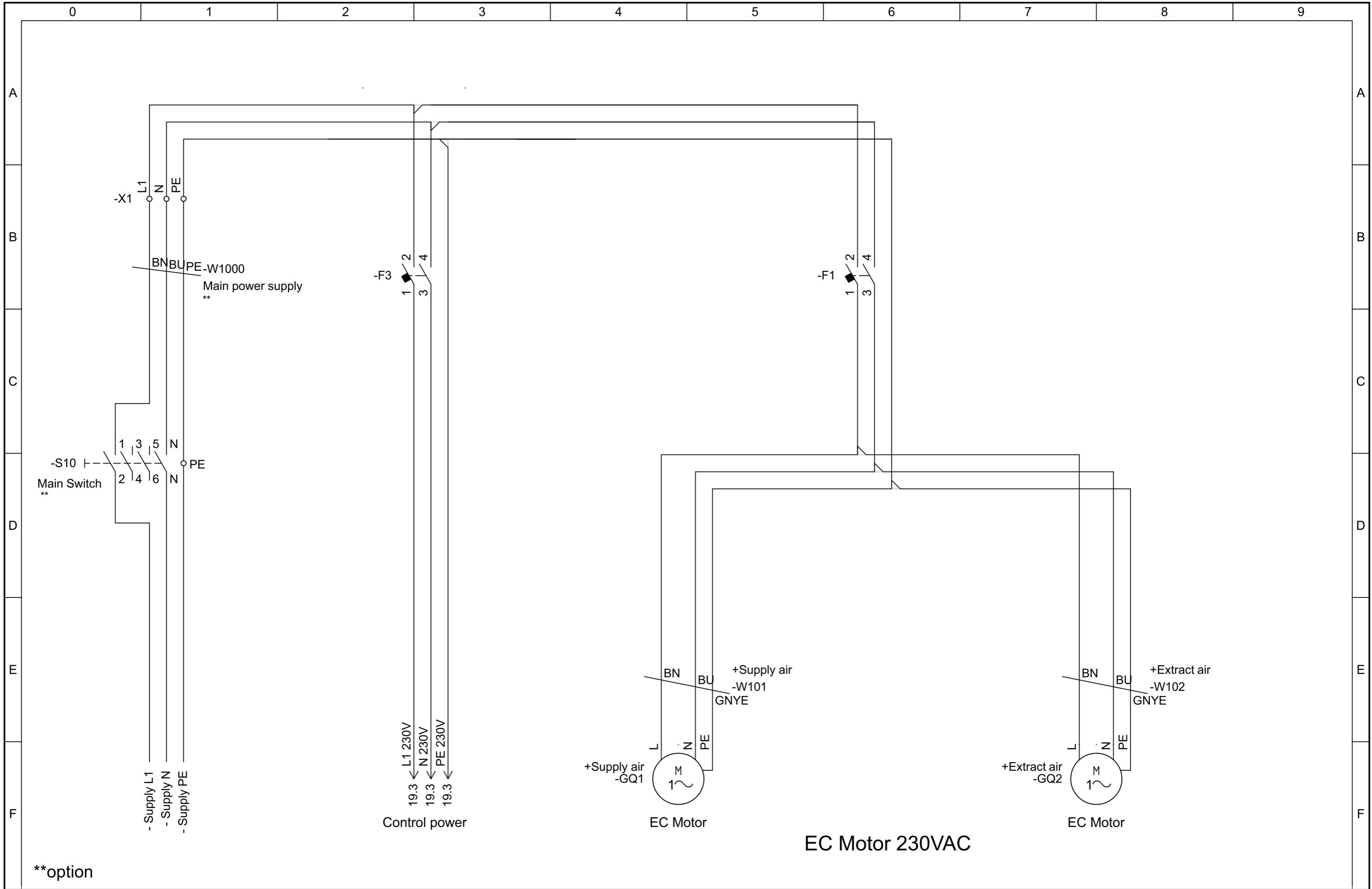

\*\*option

EC Motor 230VAC

	Geniox Access CU27 Controller	Main power EC fan	Project: Geniox-Core CS 44.04.02 230V Pre-heat GB	Rev.: 44.04.02	Sheet: 18
			Date: 06-11-2019	initials: MIKE	Total sheets: 17 Next sheet: 19

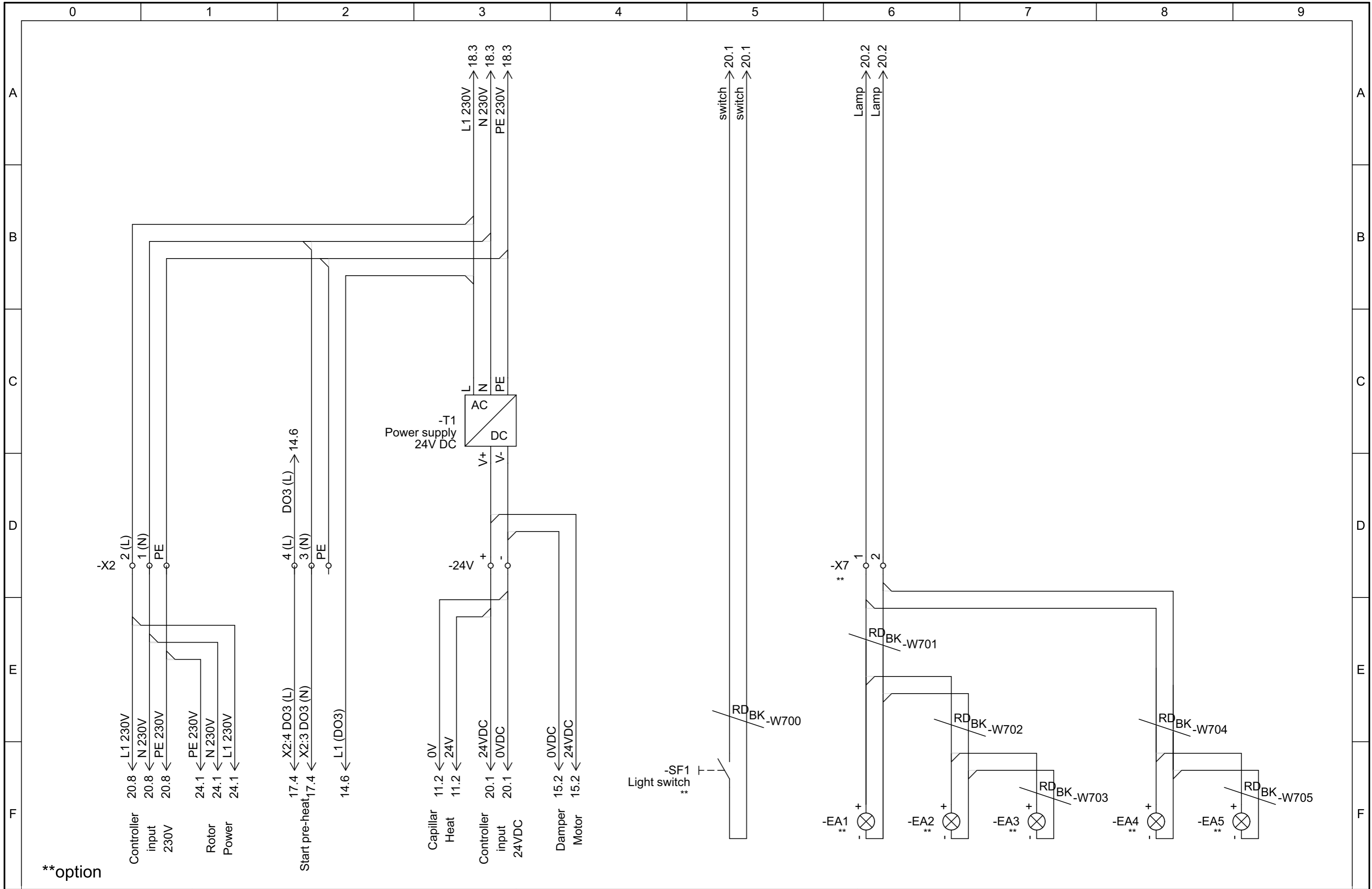

\*\*option

-KF1

### Access CU27 Controller

### Systemair A/S

DI1:T32 10.1 DI1  
Reduced speed



AI:T1 12.0 (0)  
Smoke detector



DO1:T61 14.1 DO1 (L)  
Start heating Pump  
230V out



AO1:T71 16.2 24V  
Heater 1



DI2:T31 10.2 DI2  
Normal speed ext.



AI6:T14 12.2 0V  
Pressure supply



DO2:T62 14.3 DO2  
Start cooling 1  
Heat pump cooling



AO2:T72 16.7 24V  
Cooling / DX Circuit 1  
Change over



DI3:T30 10.4 DI3  
Ext. Stop / High speed/  
Extra filter guard



AI5:T15 12.4 0V  
Pressure extract



DO3:T63 14.6 DO3  
Pre-heat / extr. Contr.



AO3:T73 17.1 24V  
Pre-heater



DI4:T29 10.6 DI4  
Cooling alarm



AI4:T16 12.7 0V  
CO2 sensor/RH sensor/



DO4:T64 15.3 DO4  
Damper



AO4:T74 17.6 24V  
Free



DI5:T28 10.8 DI5  
Ext. Change over /  
HP defrost



DO5:T65 14.8 DO5  
Alarm / Fire damper /  
Run indication



DI6:T27 11.1 DI6  
Frost thermostat



UI1:T81 13.1 24V  
Supply air



DO6:T66 15.8 DO6  
Start Heat 1/Heat Pump  
Change over



DI7:T26 11.3 DI7  
Pump  
EL-coil overheat



UI2:T82 13.3 24V  
Frost



DI8:T25 11.5 DI8  
Fire Alarm



UI3:T83 13.5 24V  
Pre-heat Frost.



DI9:T24 11.8 DI9  
EL preheat overheat



UI4:T84 13.8 24V  
Outdoor  
Intake Temp.



24VDC Input

Light

Int-link 1

Int-link 2

Ext-link

BMS

230V Input

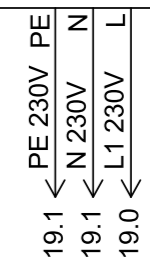
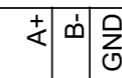
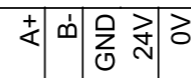
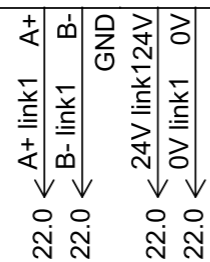
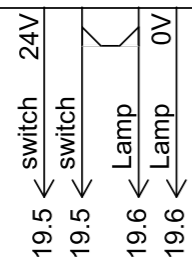
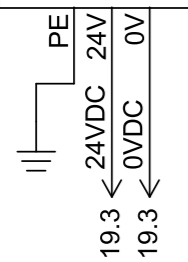

Geniox  
Access CU27 Controller

Access CU27 Controller

Project: Geniox-Core CS 44.04.02 230V Pre-heat GB

Rev.: 44.04.02

Sheet: 20

Date: 06-11-2019

initials: MIKE

Total sheets: 17

Next sheet: 21

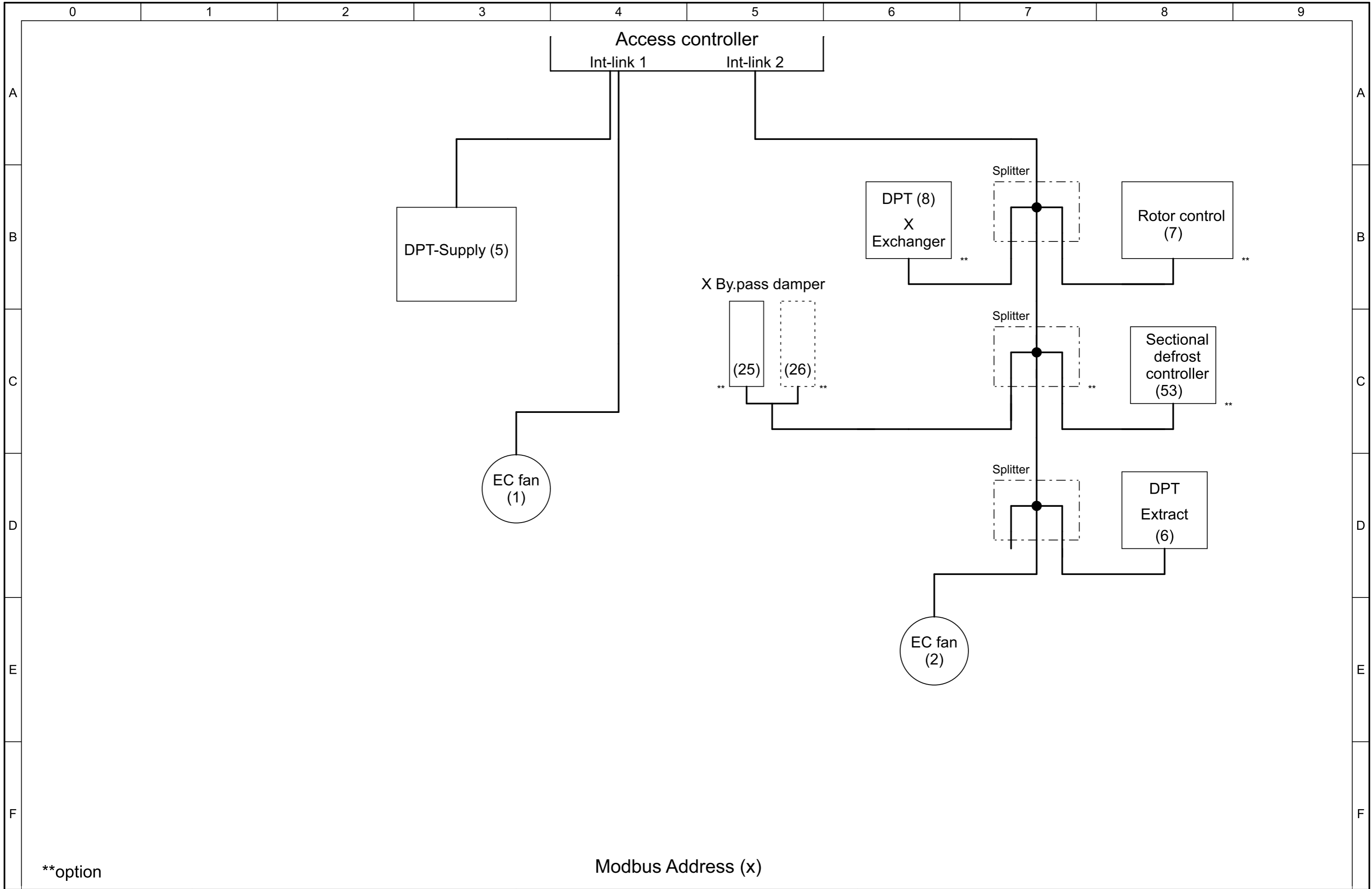

\*\*option

Modbus Address (x)



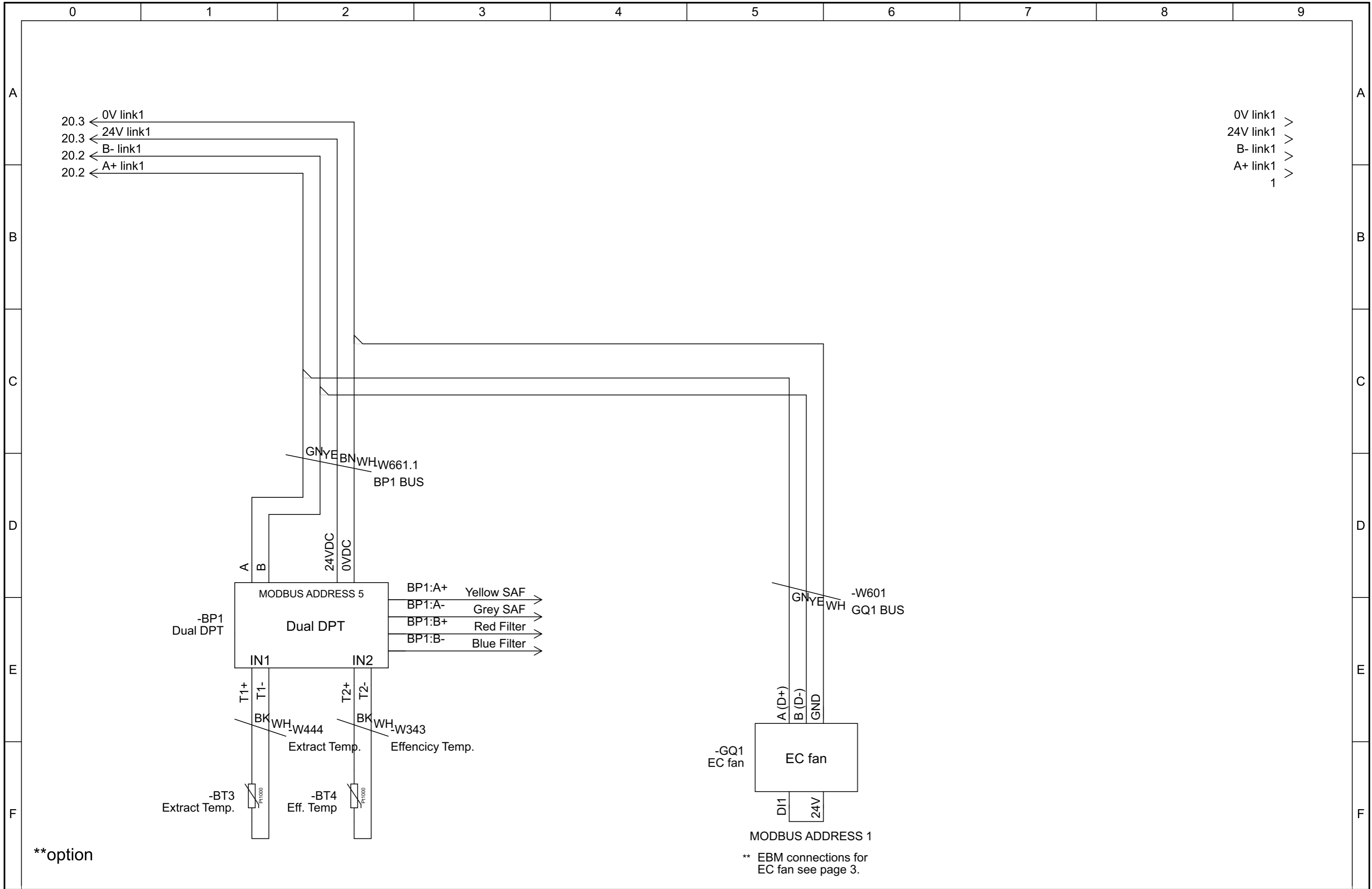

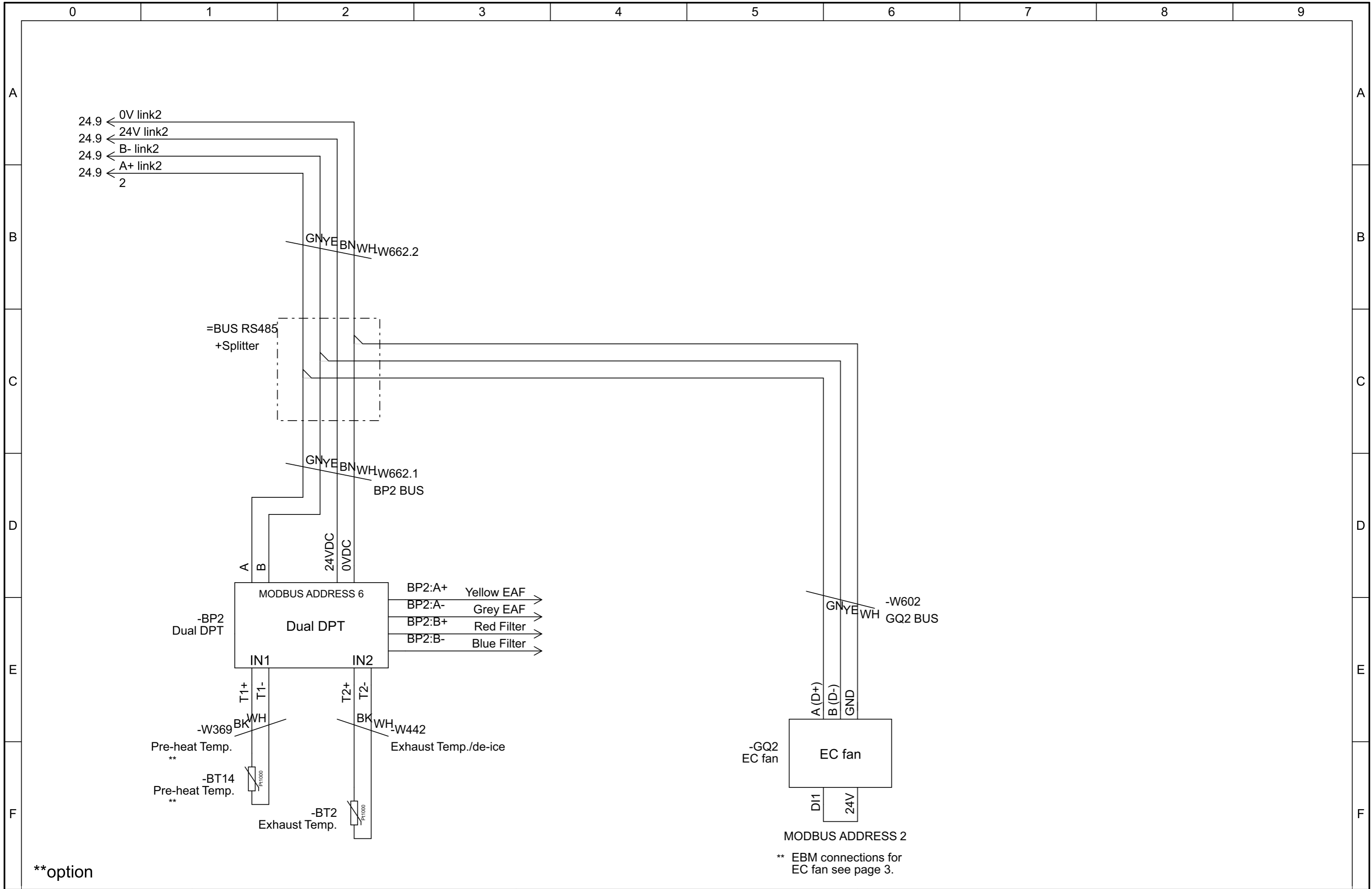

\*\*option

\*\* EBM connections for EC fan see page 3.

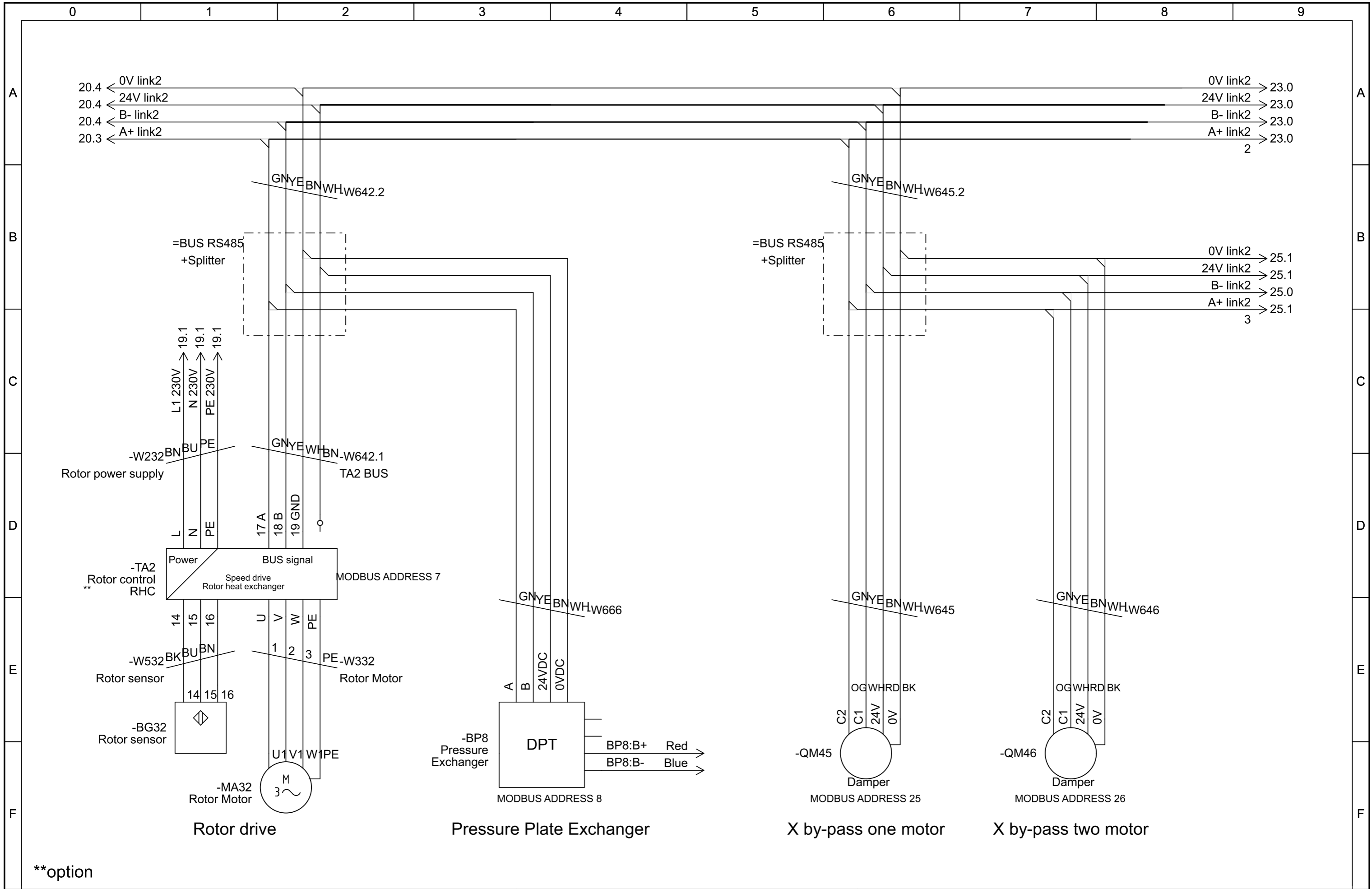

\*\*option

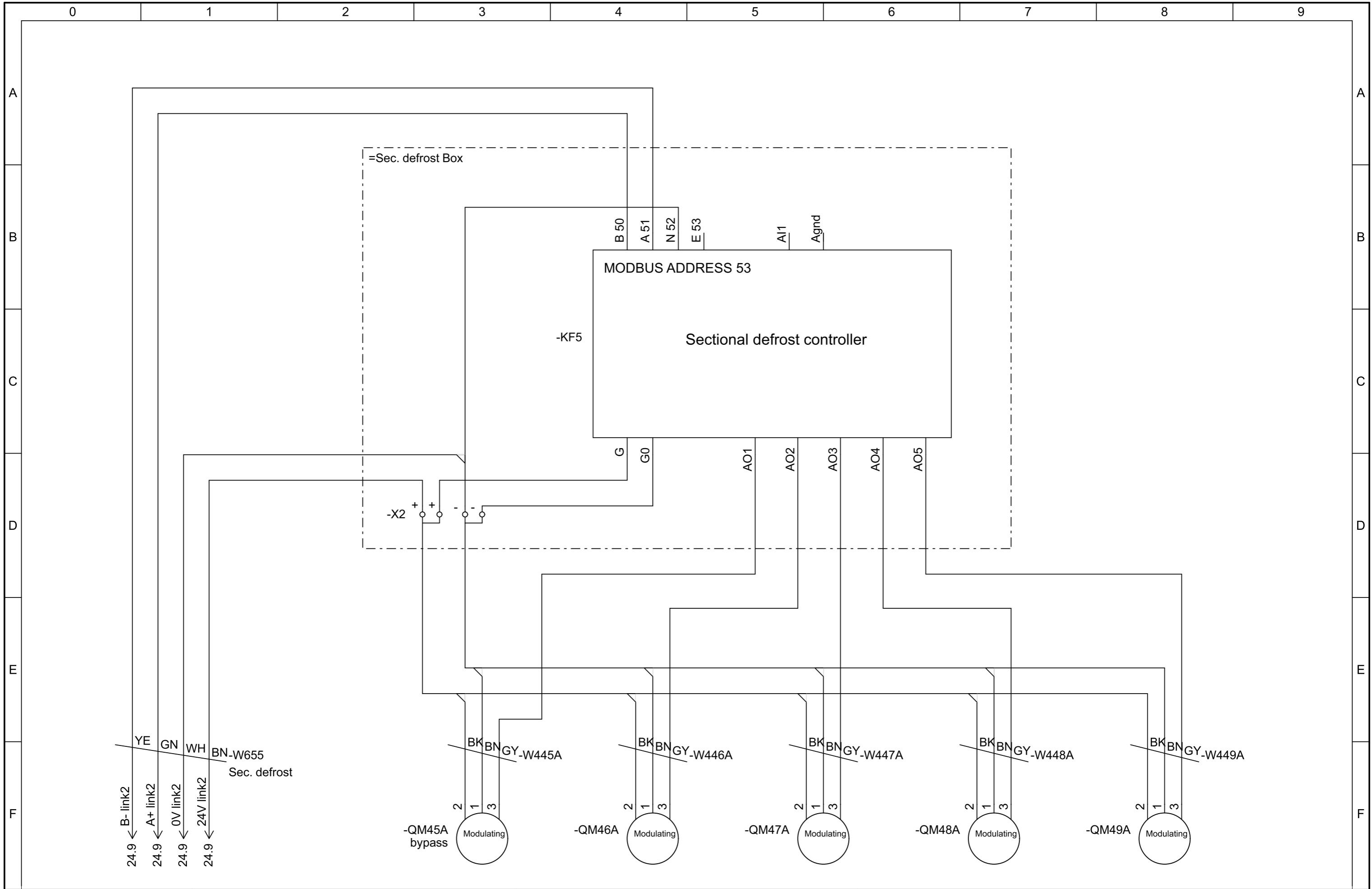

### Address list

### Systemair settings of ECblue Modbus

Address	Component: Code
1	Supply air fan 1: GQ1
2	Extract air fan 1: GQ2
3	Supply air fan 2: GQ3
4	Extract air fan 2: GQ4
5	Dual pressure transmitter supply: BP1
6	Dual pressure transmitter extract: BP2
7	RHC (Rotor drive system): TA2
8	Pressure Exchanger: BP8
25	Plate exchanger by-pass: QM45
26	Plate exchanger "by-pass" 2: QM46
53	Sectional Defrost control: KF5

COM Baudrate: 9600Bd

COM Mode: 8N1

BUS Address: Supply air, 1 and (3, Twin fans)

Extract air, 2 and (4, Twin fans)

D1: 19D

D1 is set to disable internal safety functions that protects the motor (fire mode)

Normal speed control of the fan is possible in this mode.

Function is active if D1 is open = no signal.



# Cable Plan

Path  
Sheet

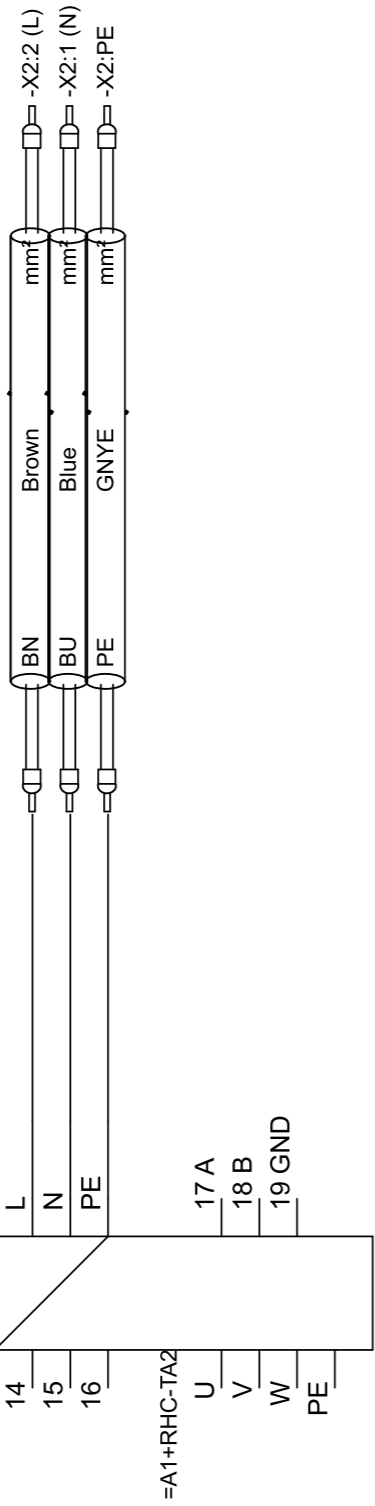

Remark: Rotor power supply  
Cable-type:

**-W232**

24  
24  
24

Remark:  
Cable-type:

**-W251**

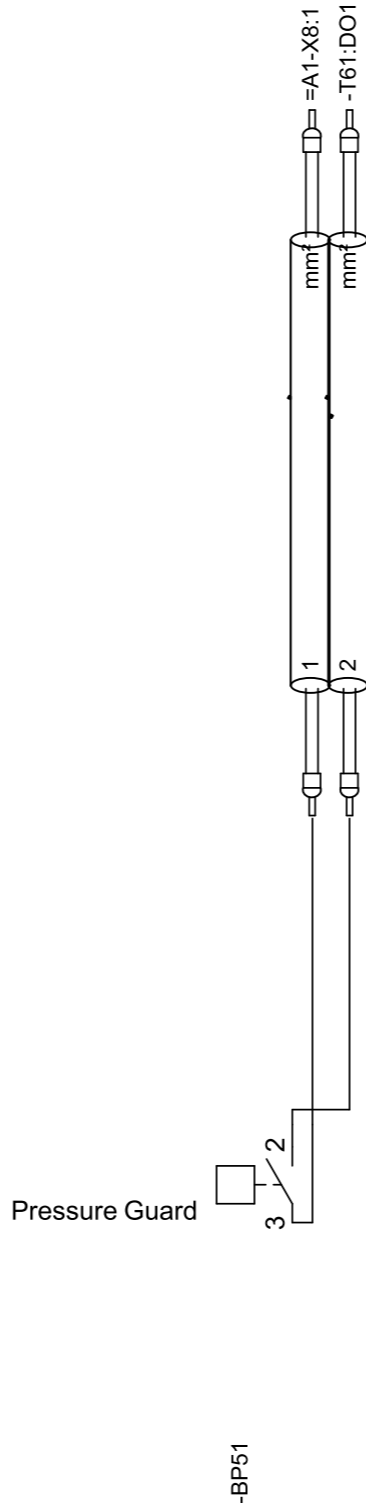

Remark:  
Cable-type:

**-W253**

14  
14

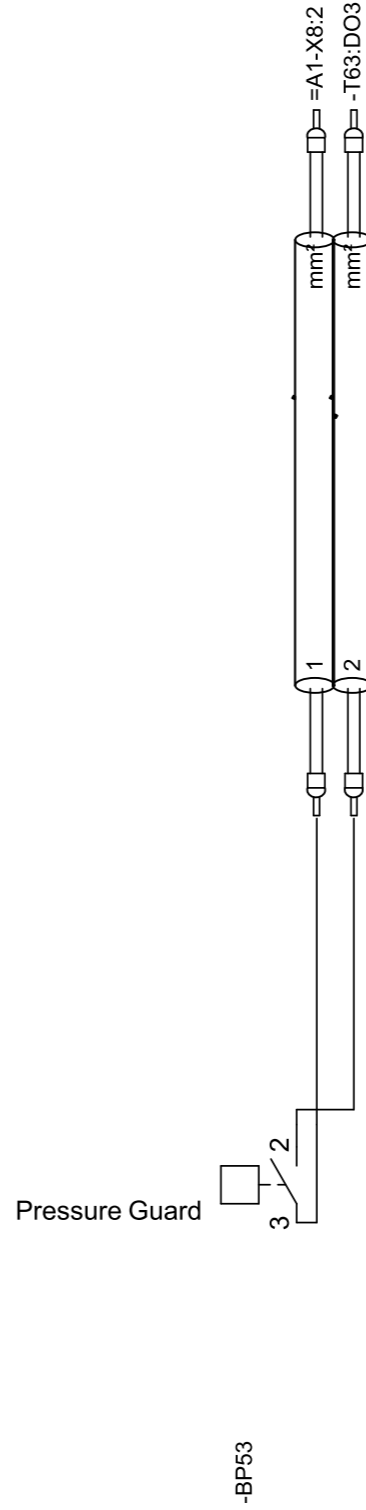

Remark: Intake Temp.  
Cable-type:

**-W341**

14  
14

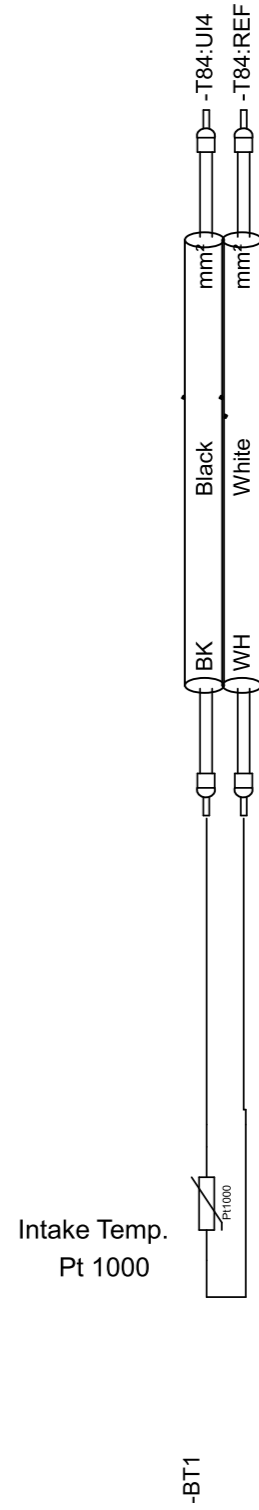

13  
13

# Cable Plan

Path  
Sheet

Remark: Electric heater  
Cable-type:

**-W351**

Electric heater

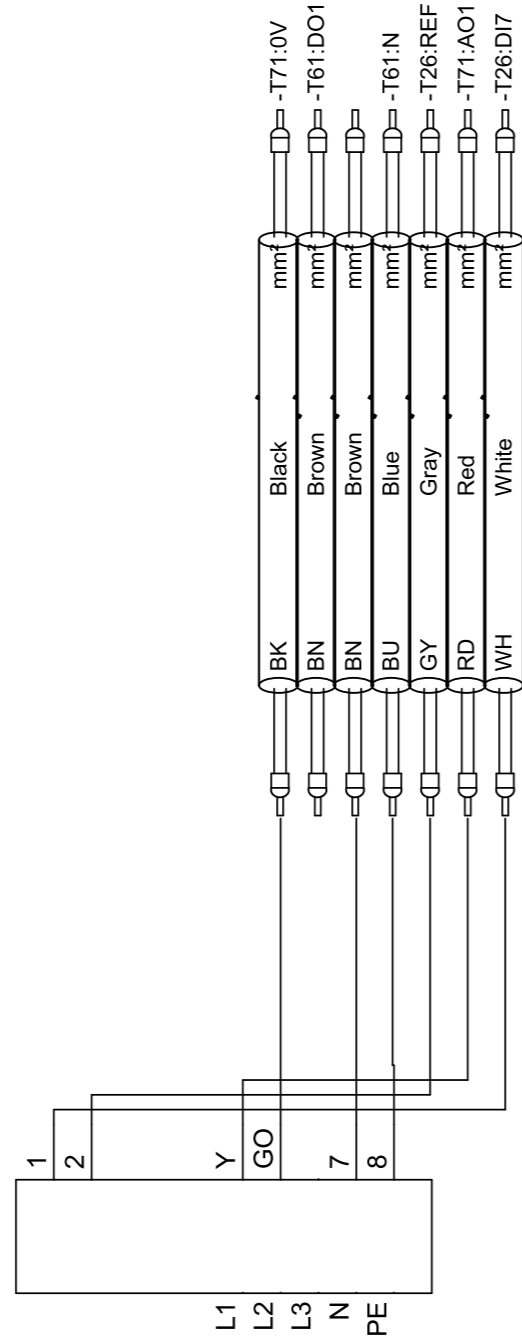

-EB51

16 4  
16 4  
16 4  
16 4  
16 3  
16 4  
16 3

Remark: Electric pre-heater  
Cable-type:

**-W353**

Electric pre-heater

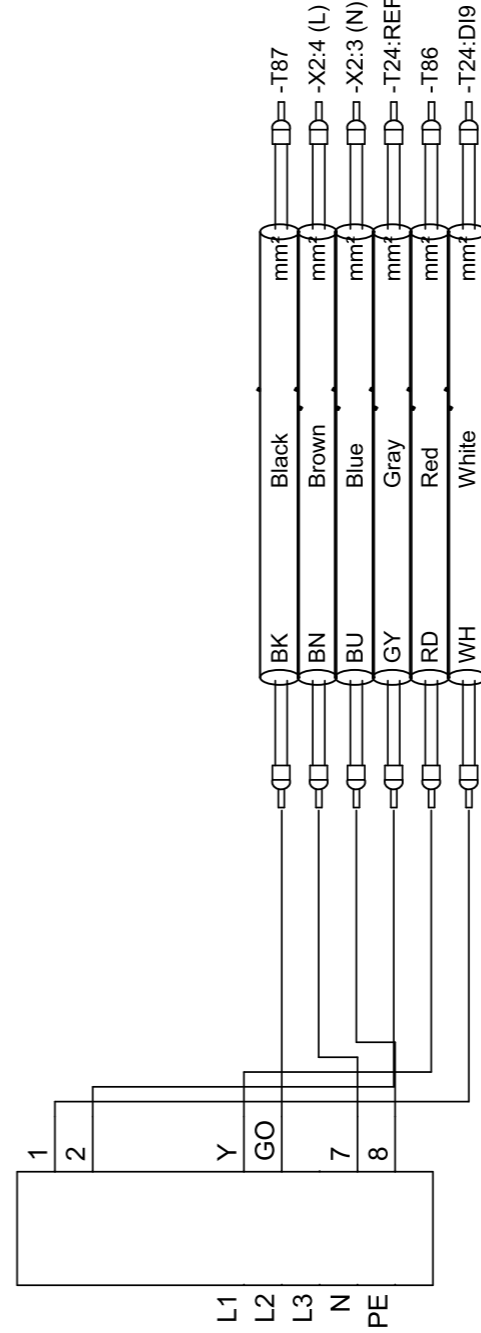

-EB53

17 4  
17 4  
17 4  
17 3  
17 4  
17 3

Remark: Temperatur sensor supply air  
Cable-type:

**-W355**

Supply air  
Duct sensor

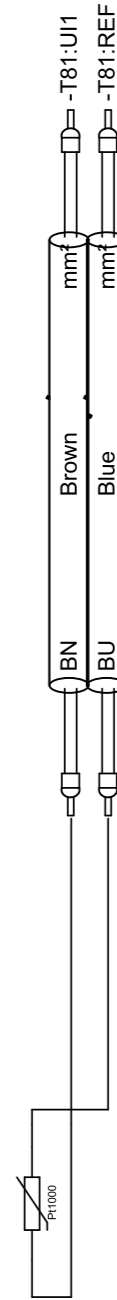

-BT5

13 1  
13 2

# Cable Plan

Path  
Sheet

Remark: Frost protection heating coil  
Cable-type:

**-W357**

Frost protection  
Pt 1000

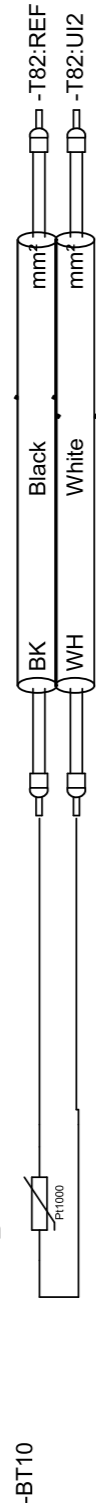

-BT10

4  
13  
3  
13

**-W359**

Remark: Frost thermostat  
Cable-type:

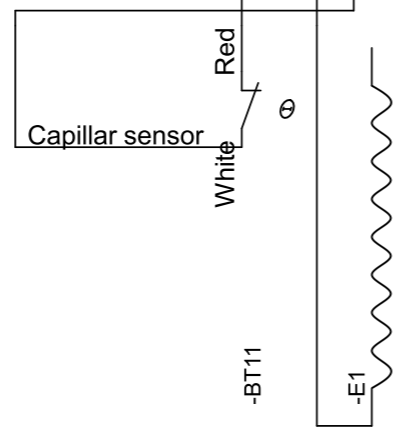

-BT11

2  
11  
2  
11  
1  
11

**-W363**

Remark: Extra filter guard  
Cable-type:

Extra filterguard  
Supply air

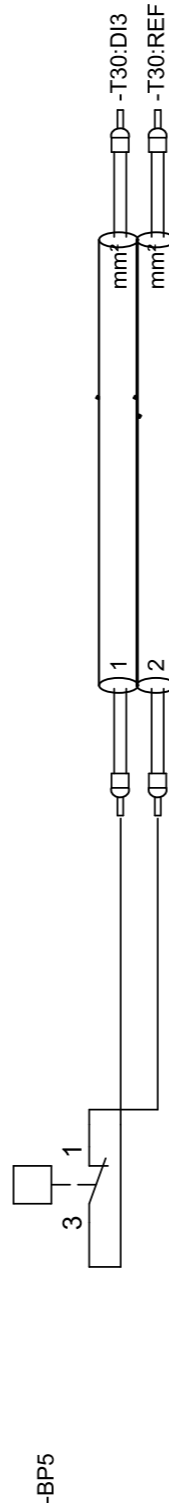

-BP5

4  
10  
4  
10

**-W367**

Remark: Pre-heat Frost  
Cable-type:

Pre-heat Frost  
Pt 1000

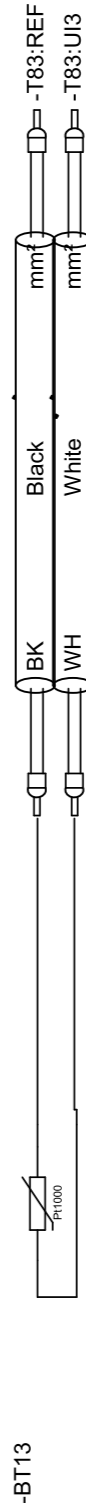

-BT13

6  
13  
5  
13



# Cable Plan

Path  
Sheet

Remark: Pre-heat Temp.  
Cable-type:

**-W369**

Pre-heat Temp.

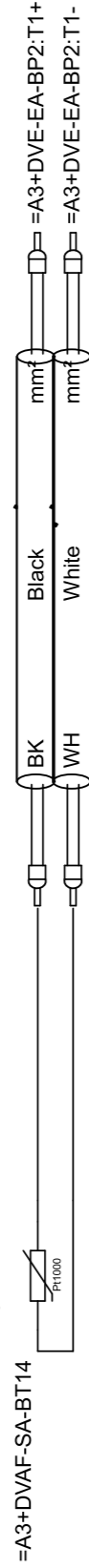

Remark:  
Cable-type:

**-W445A**

bypass

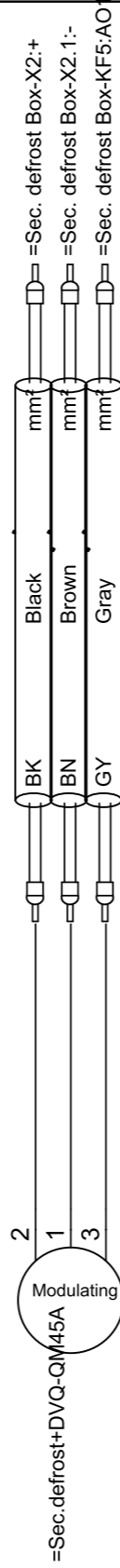

Remark:  
Cable-type:

**-W446A**

Modulating

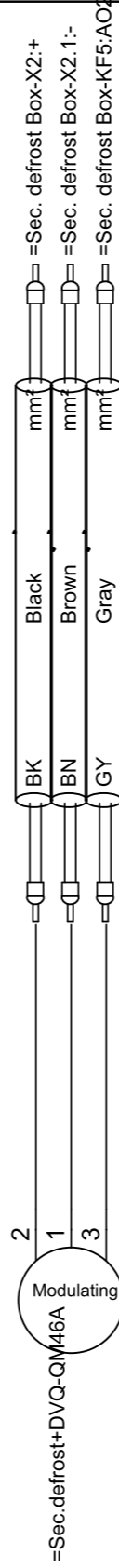

Remark:  
Cable-type:

**-W447A**

Modulating

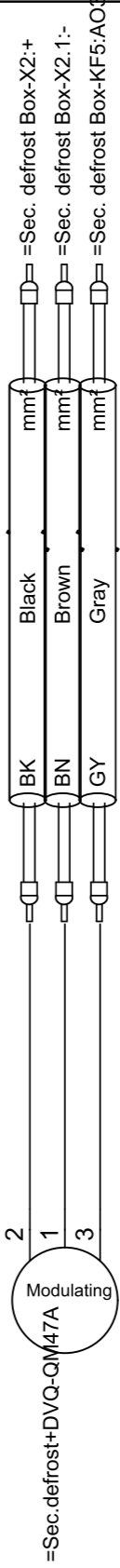

# Cable Plan

Path  
Sheet

**-W448A**

Remark:  
Cable-type:

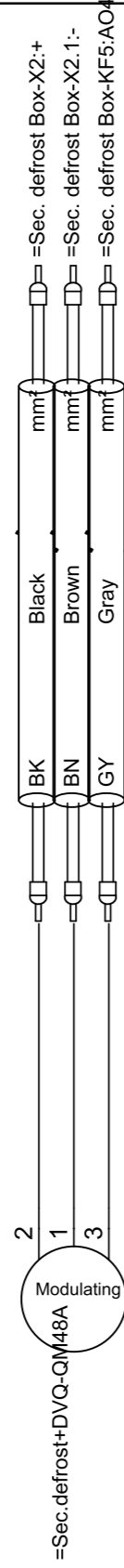

7  
25  
7  
25  
7  
25

**-W449A**

Remark:  
Cable-type:

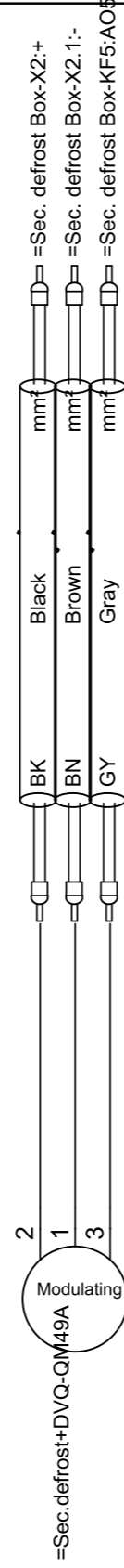

8  
25  
8  
25  
8  
25

**-W456**

Remark: Fire thermostat extract air  
Cable-type:

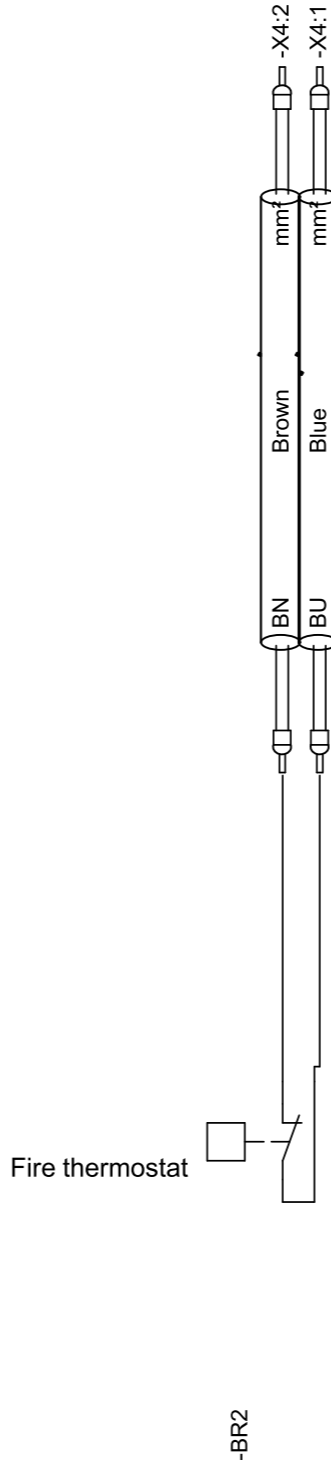

11  
11

**-W457**

Remark: Fire thermostat  
Cable-type: 2x0,75mm²

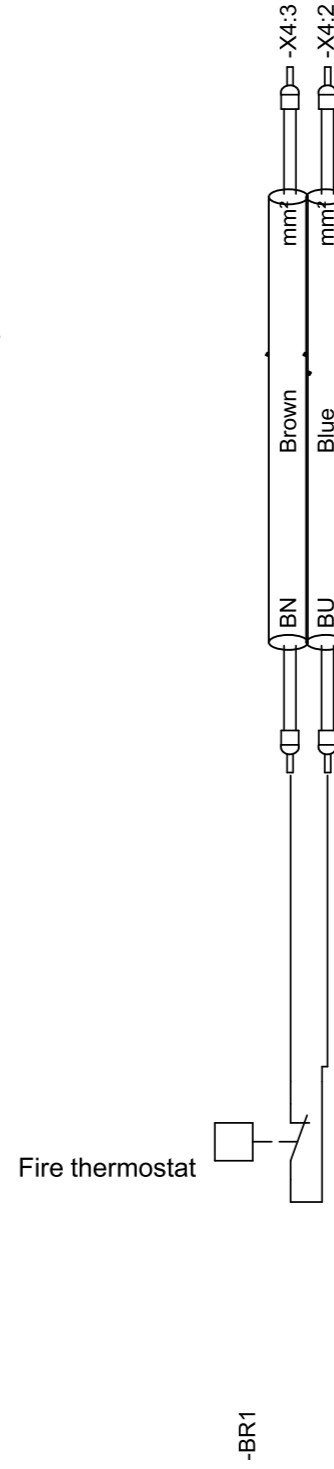

11  
11

# Cable Plan

Path  
Sheet

Remark: Smoke detector  
Cable-type:

-W458

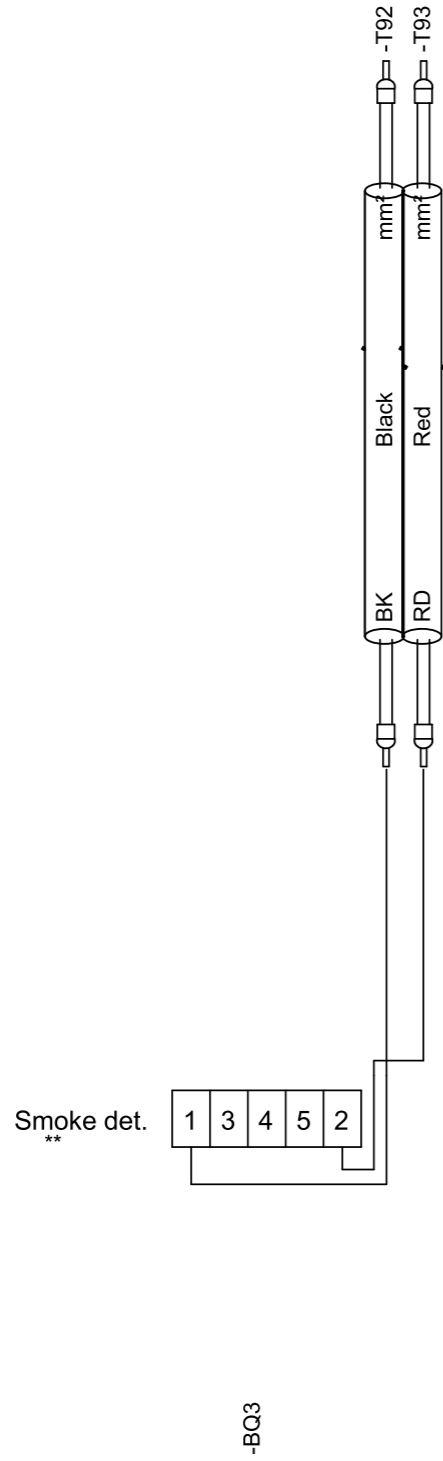

-BQ3

Remark: Outdoor sensor  
Cable-type:

-W507

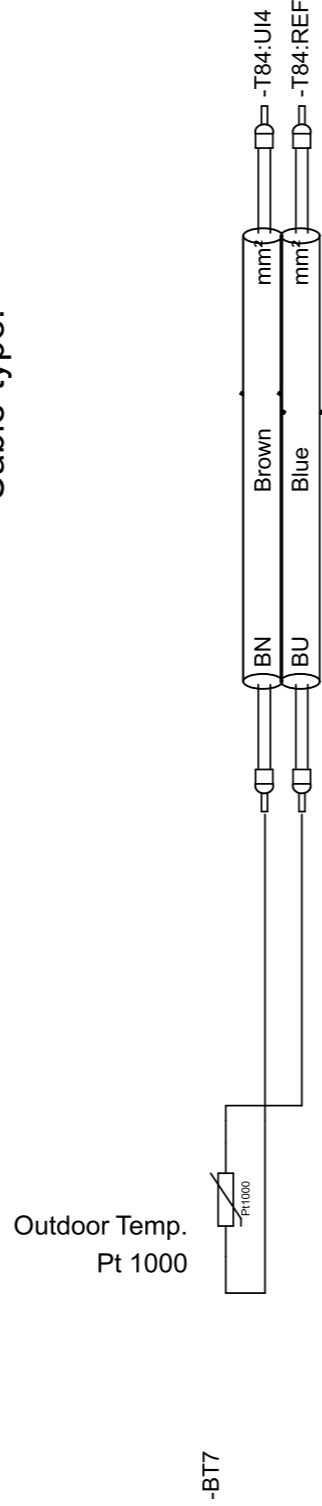

-BT7

Remark: Room sensor 1  
Cable-type:

-W508



Remark: Pressure Supply air external  
Cable-type:

-W513

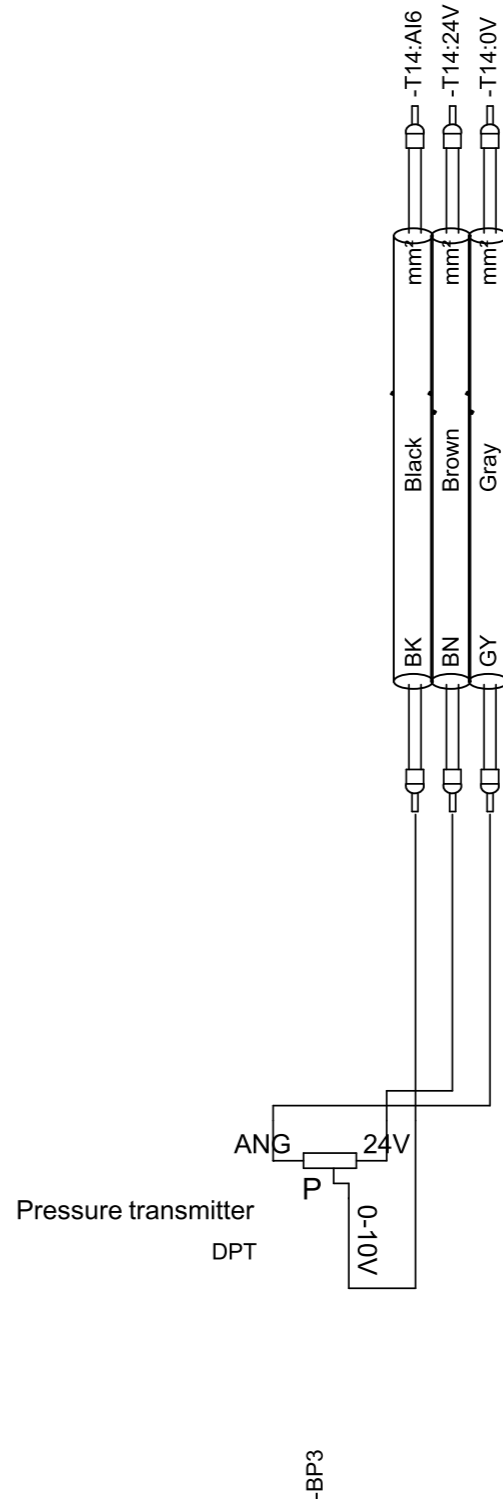

-BP3

0  
12

1  
12

8  
13

8  
13

8  
12

9  
12

9  
12

3  
12

3  
12

2  
12

# Cable Plan

Path  
Sheet

Remark: Pressure Extract air external  
Cable-type:

**-W514**

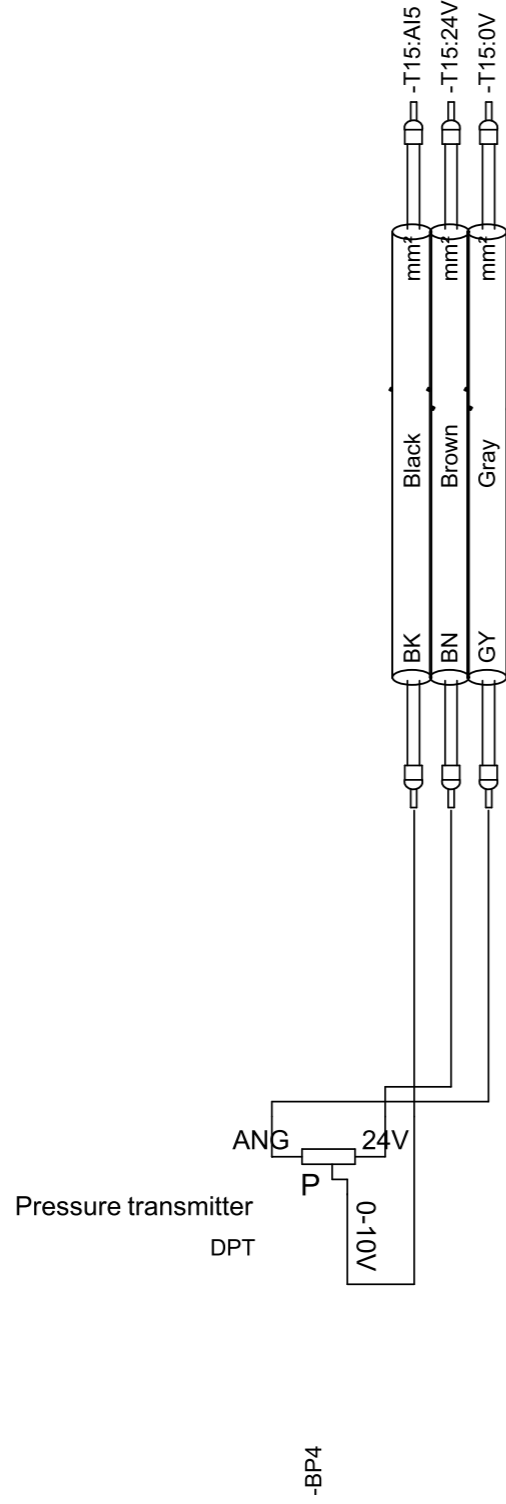

**-W515/516**

Remark: CO2 sensor  
Cable-type:

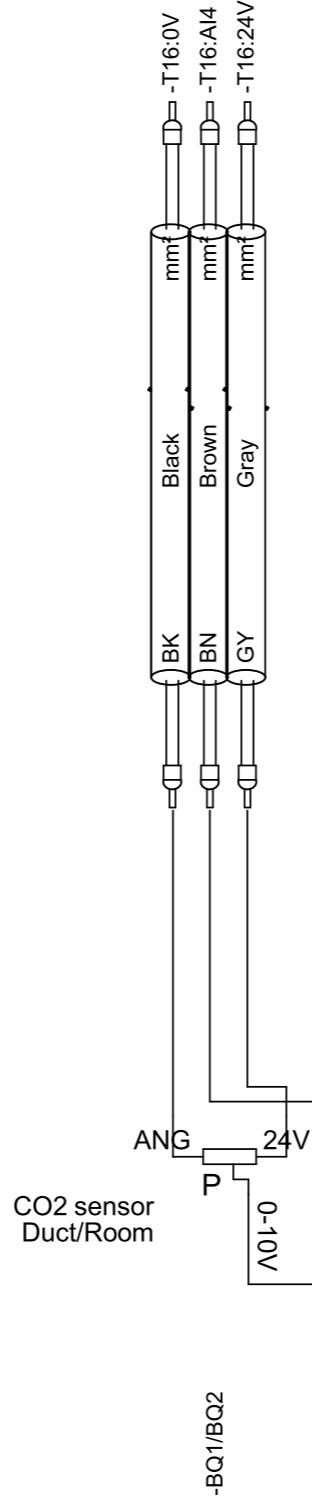

**-W517/W520**

Remark: RH sensor  
Cable-type:

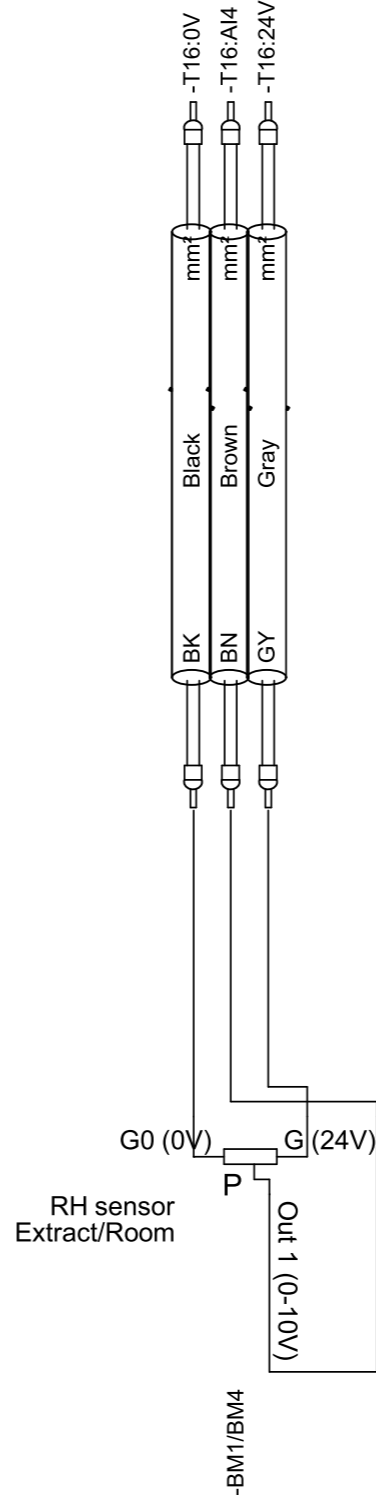

**-W531.1**

Remark: Damper Supply  
Cable-type:

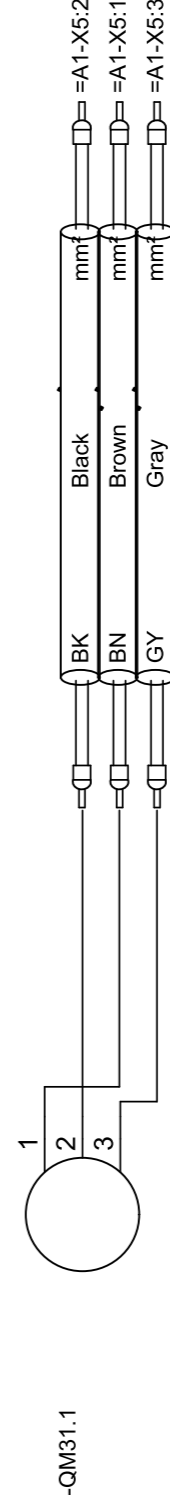

**-W531.1S**

Remark: Damper Supply  
Cable-type:

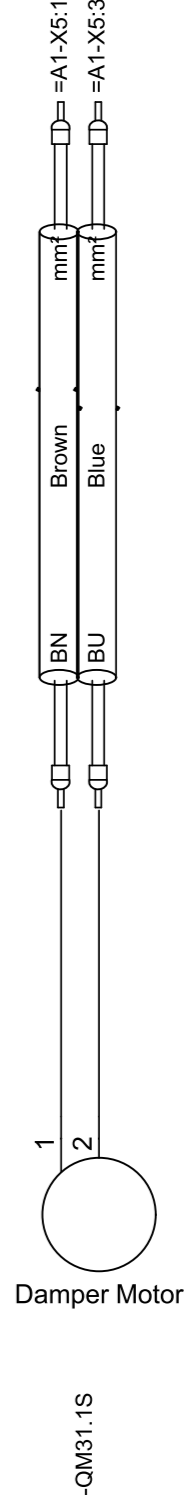

4  
5  
4

6  
6  
6

7  
7  
7

1  
0  
1

1  
1

12  
12  
12

12  
12  
12

12  
12  
12

15  
15  
15

15  
15

# Cable Plan

Path  
Sheet

**-W532.1**

Remark: Damper Extract  
Cable-type:

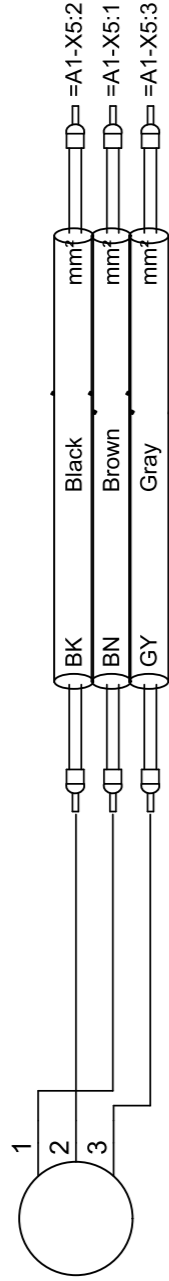

-QM32.1

4  
15  
15  
15

**-W532.1S**

Remark: Damper Extract  
Cable-type:



-QM32.1S

5  
15  
15

**-W551**

Remark: Heating valve  
Cable-type:

Valve Heating

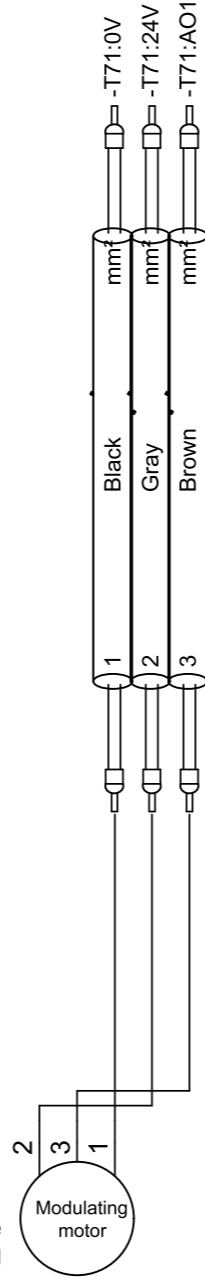

-QN51

2  
16  
16  
16

**-W553**

Remark: Heating valve  
Cable-type:

Valve Pre-Heating

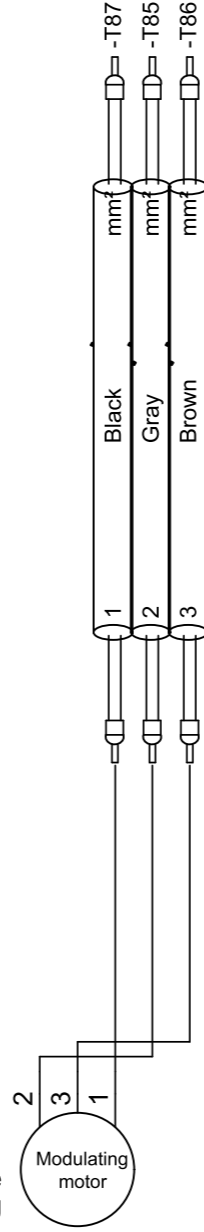

-QN53

2  
17  
17  
17

**-W571.1**

Remark: Damper Supply 2  
Cable-type:

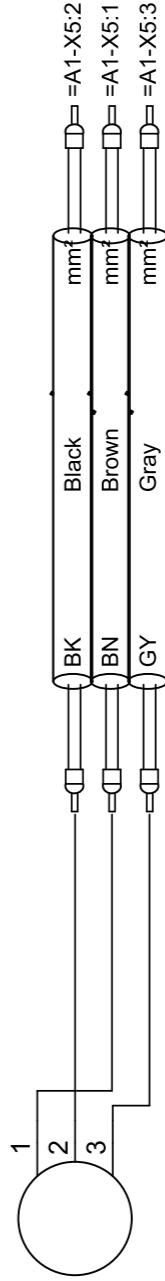

-QM71.1

2  
15  
15  
15

**-W571.1S**

Remark: Damper Supply 2  
Cable-type:

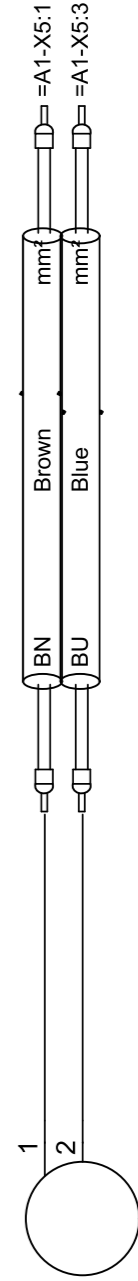

-QM71.1S

3  
15  
15

# Cable Plan

Path  
Sheet

**-W572.1**

Remark: Damper Extract 2  
Cable-type:

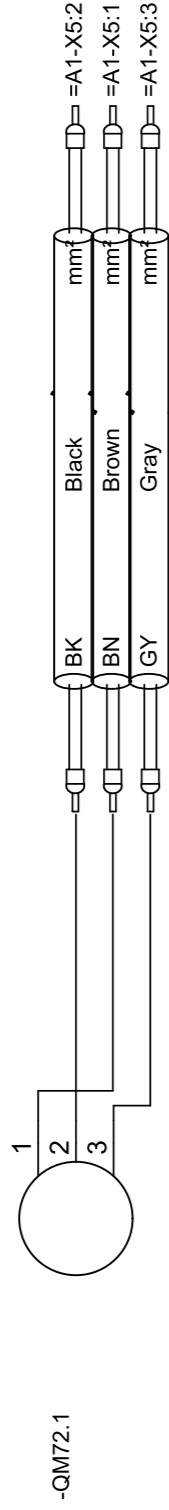

-QM72.1

**-W572.1S**

Remark: Damper Extract 2  
Cable-type:



-QM72.1S  
Damper Motor

**-W580**

Remark: Reduced speed  
Cable-type: 2x0,75mm<sup>2</sup>

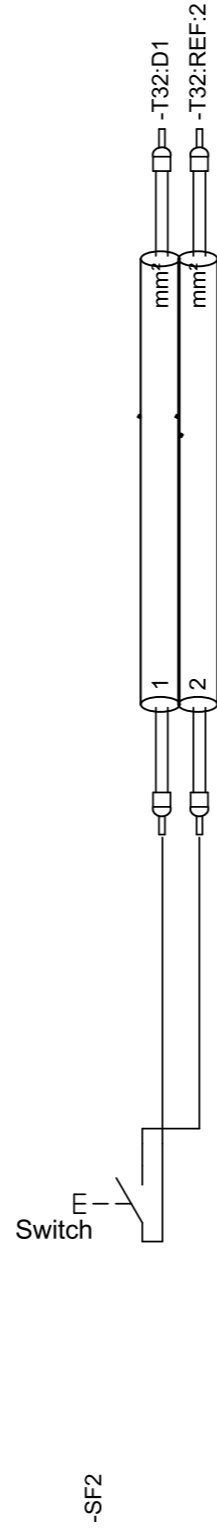

-SF2

**-W581**

Remark: Normal speed-ext.  
Cable-type:

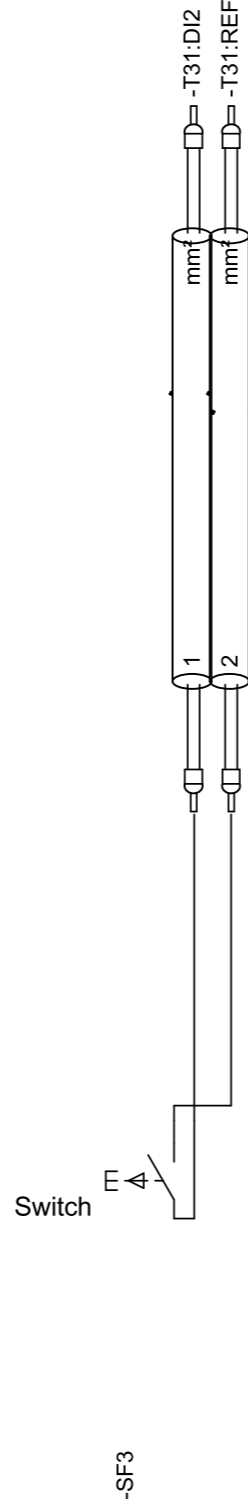

-SF3

**-W583**

Remark: Ext. stop  
Cable-type: 2x0,75mm<sup>2</sup>

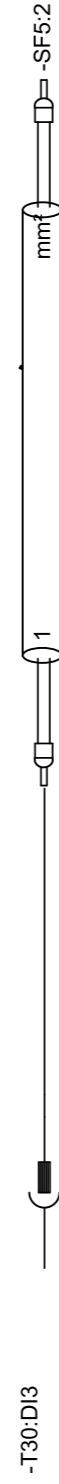

-T30:D13

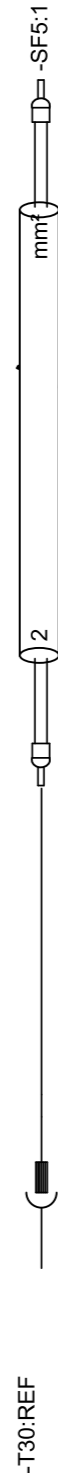

-T30:REF

**-W584**

Remark: Change over  
Cable-type:

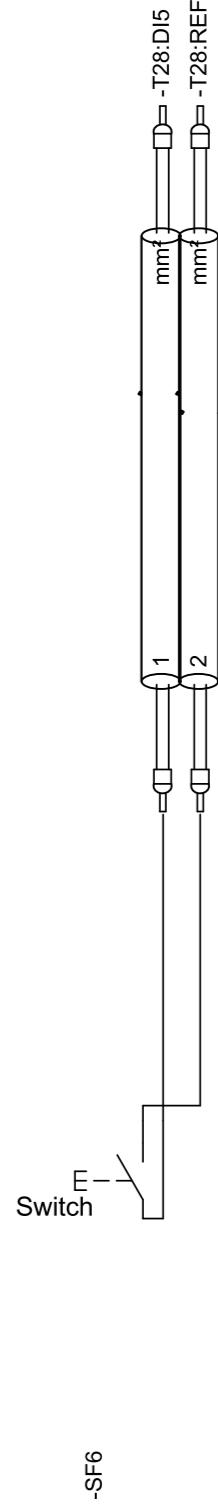

-SF6

15	6
15	6
15	6

15	7
15	7

10	1
10	1

10	2
10	3

10	5
----	---

10	5
----	---

10	8
10	8

# Cable Plan

Path  
Sheet

Remark: GQ1 BUS  
Cable-type: 4x0,6mm<sup>2</sup>

**-W601**

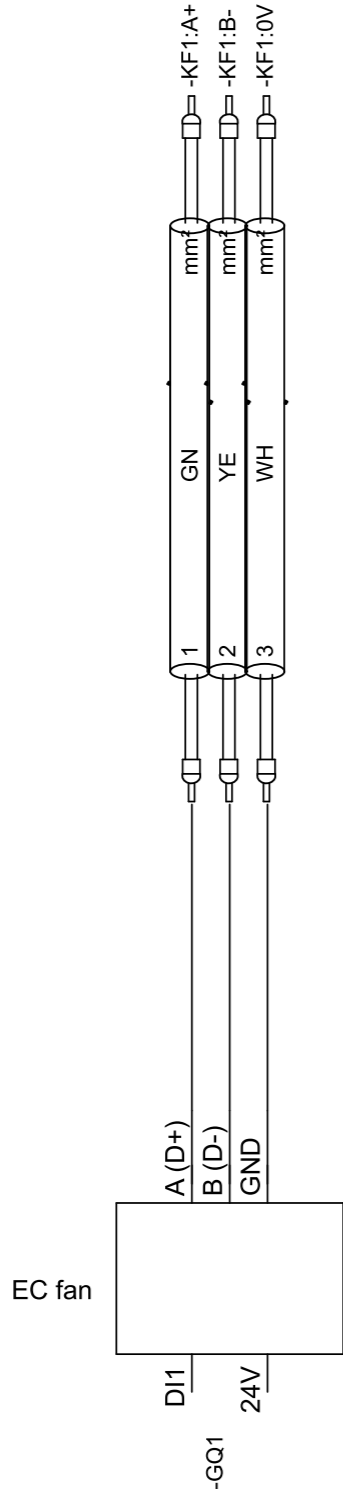

5  
22  
5  
22  
6  
22

Remark: GQ2 BUS  
Cable-type: 4x0,6mm<sup>2</sup>

**-W602**

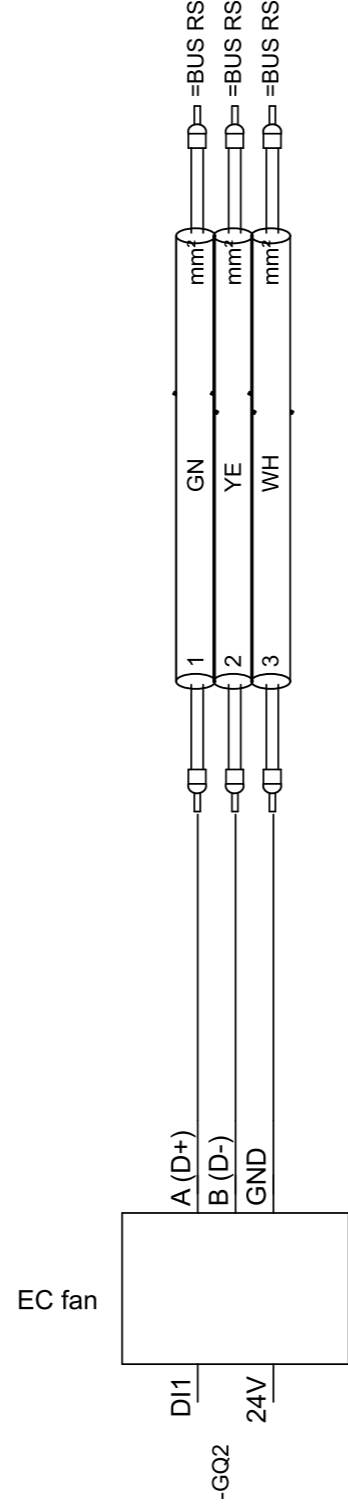

6  
6  
6

Remark: TA2 BUS  
Cable-type:

**-W642.1**

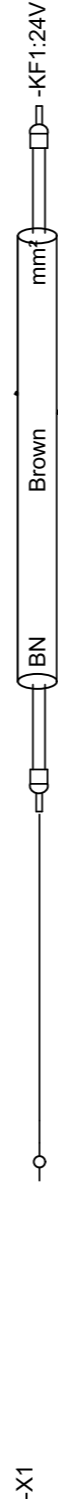

2  
24

Rotor control  
RHC

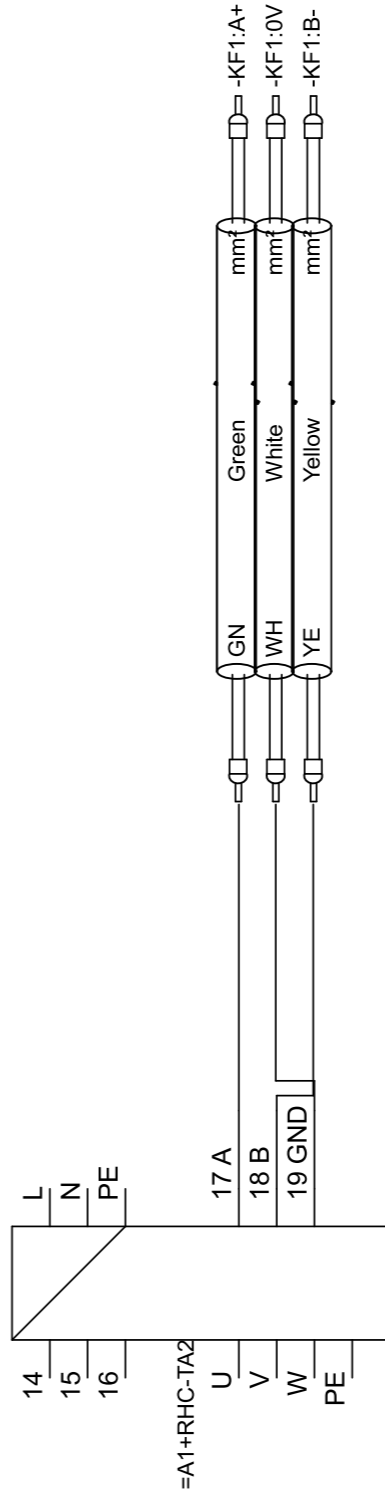

1  
24  
2  
24  
2  
24

# Cable Plan

Path  
Sheet

Remark: Extract  
Cable-type:

-W645

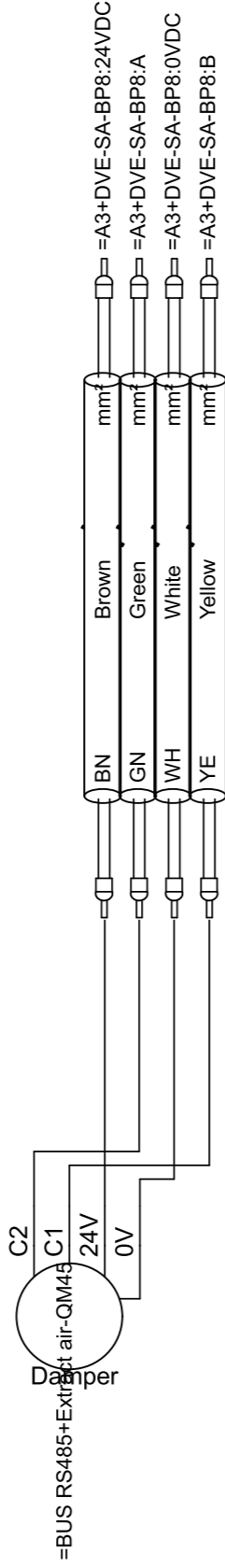

-W646

Remark: Extract  
Cable-type:

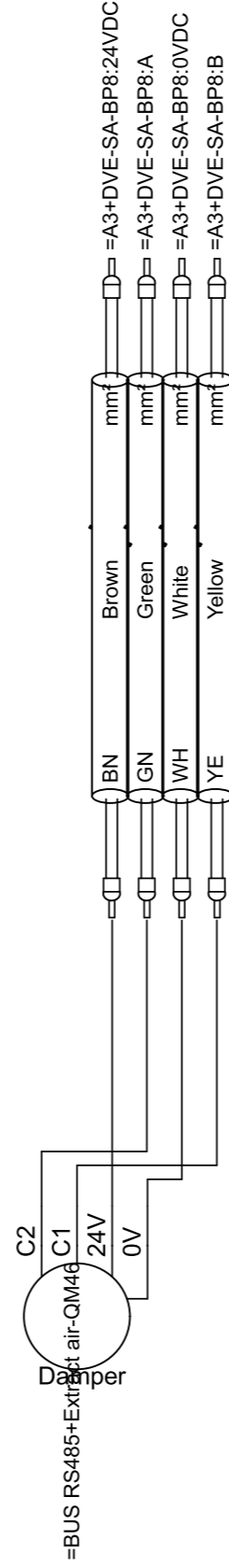

-W655

Remark: Sec. defrost  
Cable-type:

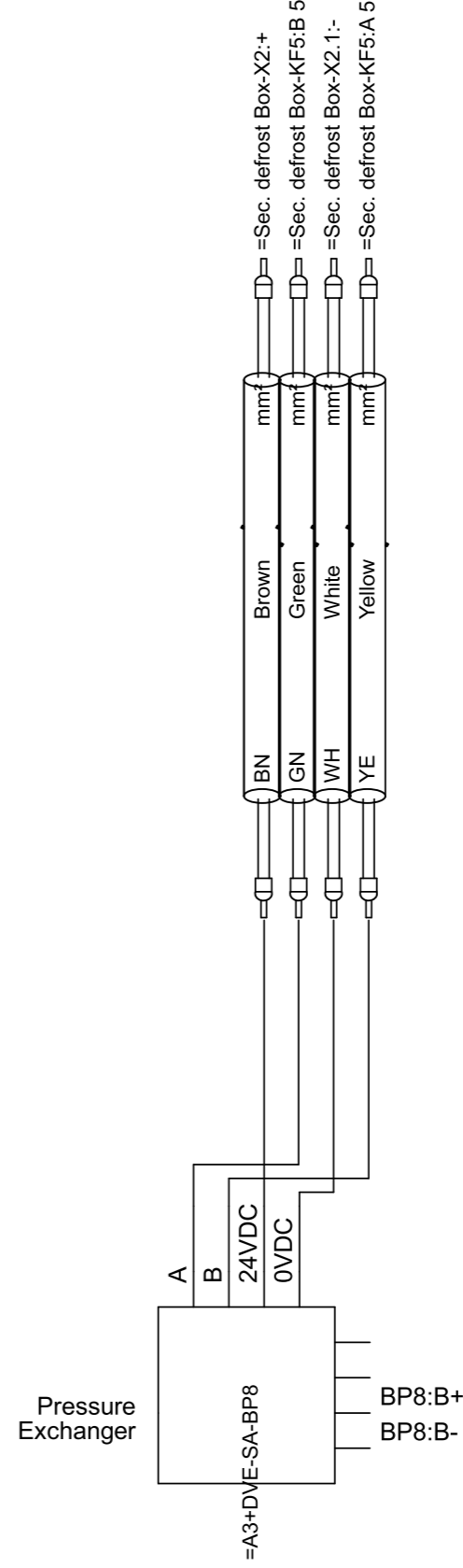

6  
24  
6  
24  
6  
24  
6  
24

7  
24  
7  
24  
8  
24  
7  
24

1  
25  
1  
25  
1  
25  
0  
25



# Cable Plan

Path  
Sheet

Remark: Pressure Plate  
Cable-type:

**-W666**

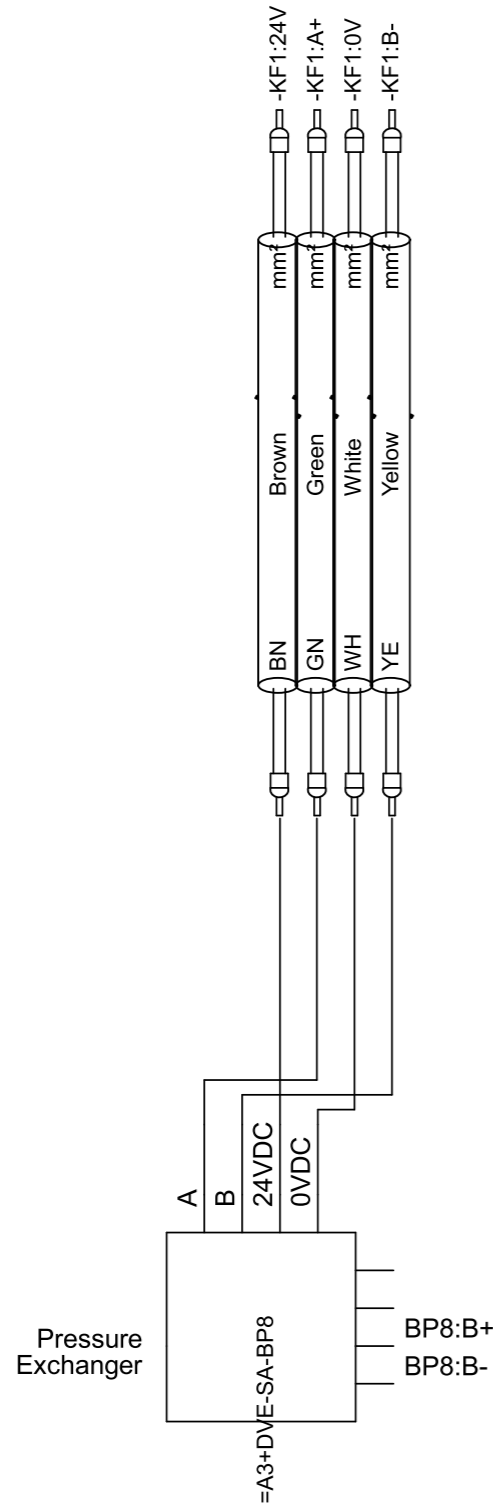

24  
24  
24  
24

4  
3  
4  
3

Remark: Main power supply  
Cable-type:

**-W1000**

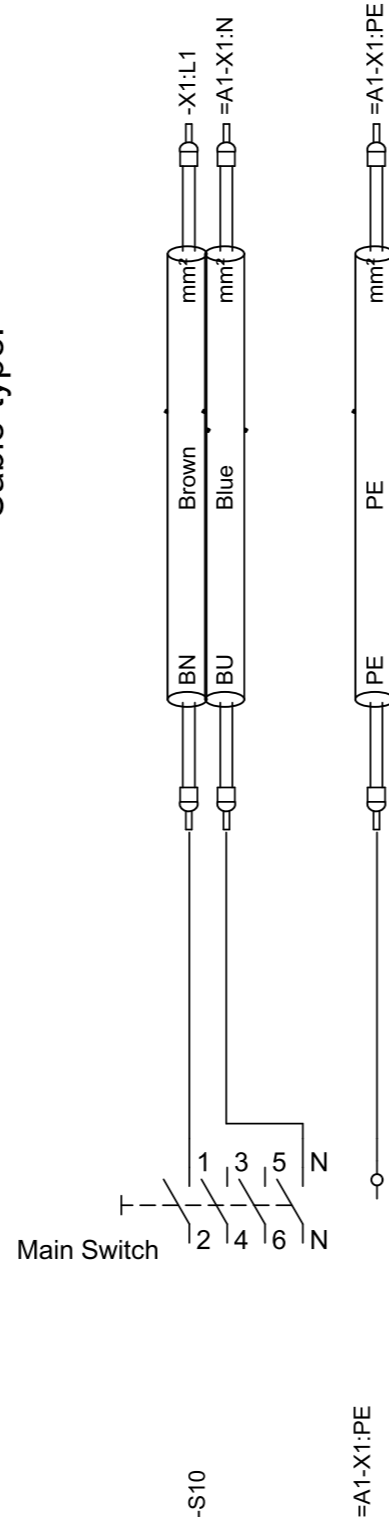

18  
18  
18

1  
1  
1

Remark: Rotor Motor  
Cable-type:

**=A1-W332**

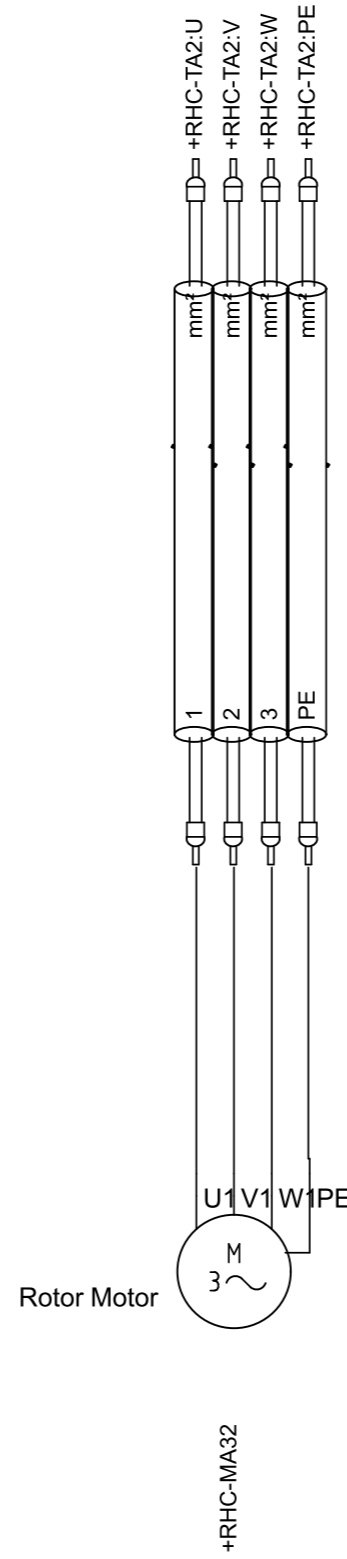

24  
24  
24  
24

1  
2  
2  
2

Remark: Rotor sensor  
Cable-type:

**=A1-W532**

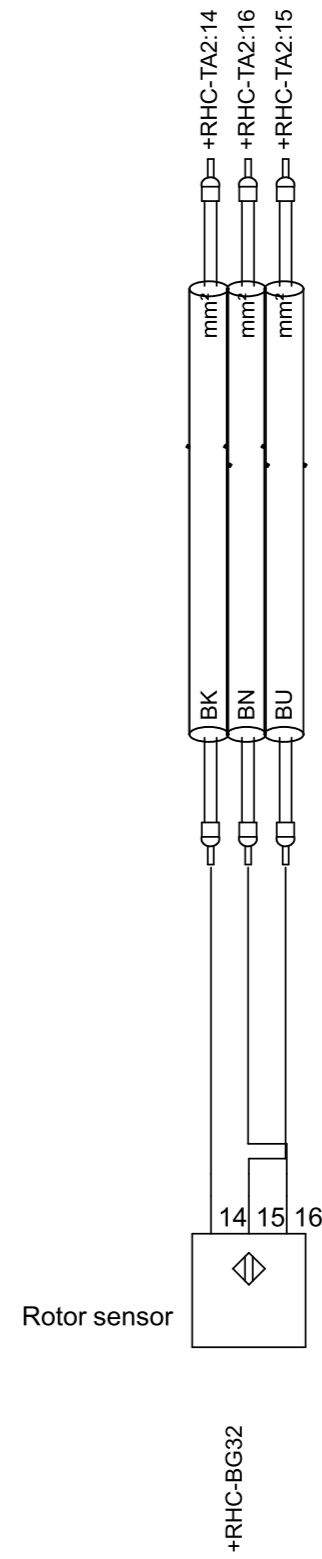

24  
24  
24

1  
1  
1

# Cable Plan

Path  
Sheet

1	2	2	7	7	7	5	5	6	6	7	6
14	14	14	16	16	16	19	19	19	19	19	19

**=A1-W550**

Remark: Mixing pump  
Cable-type:

Mixer pump 1

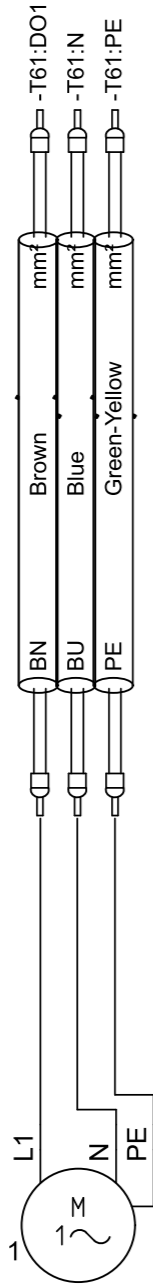

-GP50

**=A1-W554**

Remark: Cooling valve  
Cable-type:

Valve for cooling/  
Change over

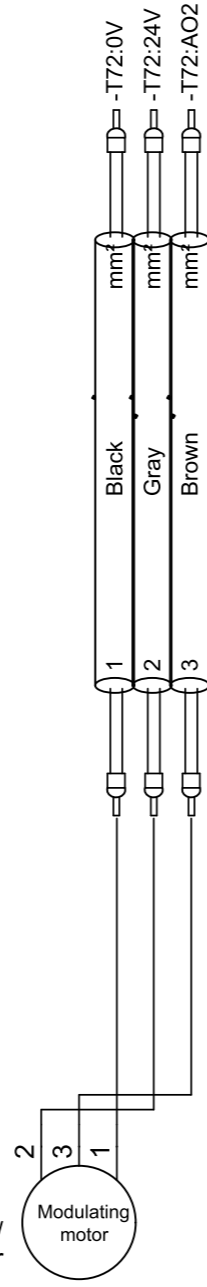

-QN54/QN56

**=A1-W700**

Remark: Light switch  
Cable-type:

Light switch

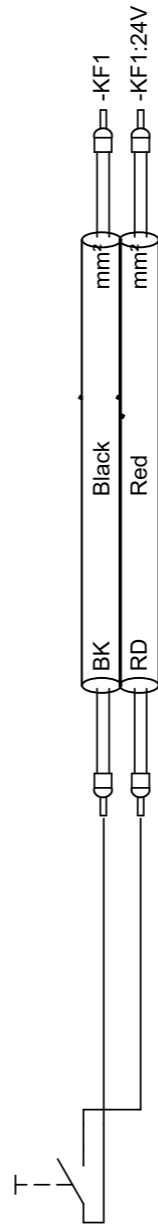

-SF1

**=A1-W701**

Remark: Light P20  
Cable-type:

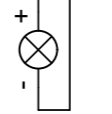

-EA1

**=A1-W702**

Remark: Light P20  
Cable-type:

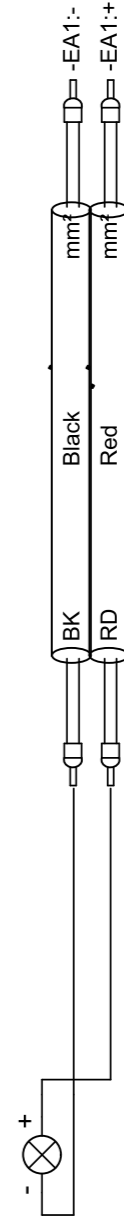

-EA2





# Cable Plan

Path  
Sheet

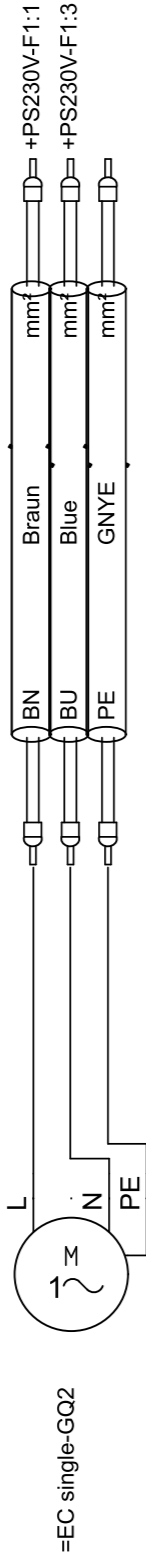

18  
18  
18

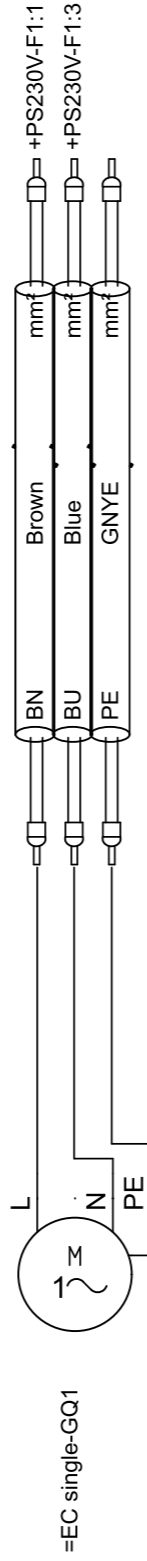

18  
18  
18

-W102, -W101