

Quick Guide

Control system FC for fan heaters

FCDF - FC Direct, FCSF - FC Smart
FCPF - FC Pro, FCBF - FC Building

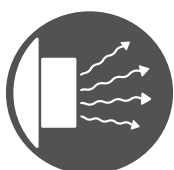
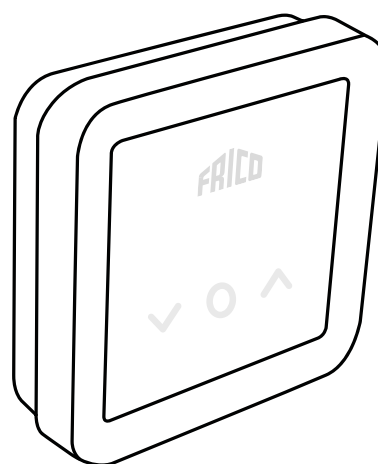

FC Control system

The fan heater must be supplemented with a FC control system.

FC Control system helps to create many smart and energy saving features. In addition to our four packages, components can be added to expand and customize the system.

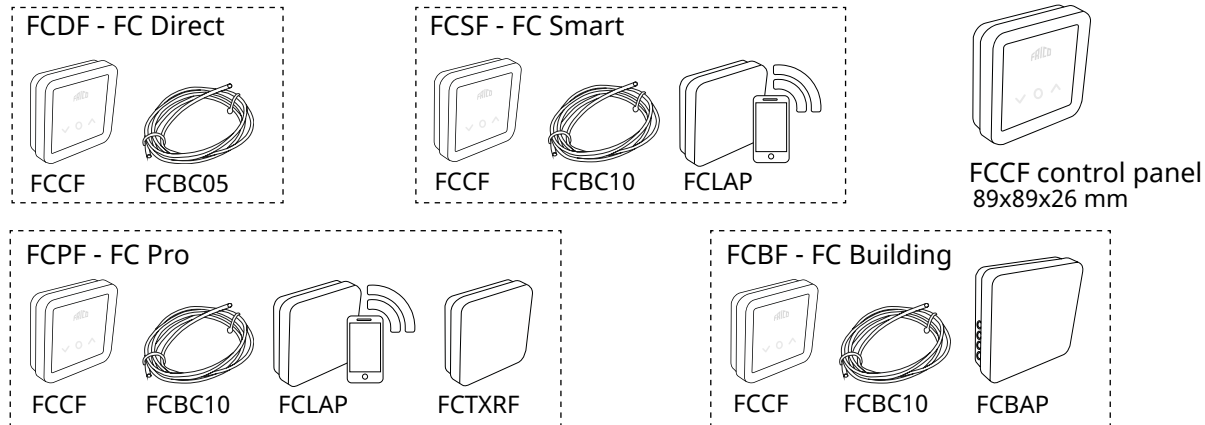

Item number	Type	Description		
74688	FCDF	FC Direct, first level control system		FCRTX IP20
74689	FCSF	FC Smart, second level control system		FCOTX IP44
74690	FCPF	FC Pro, third level control system		FCLAP IP44
74691	FCBF	FC Building, BMS system		FCTXRF IP44
				FCWTA IP65
				FCBAP IP44

Control system content and accessories

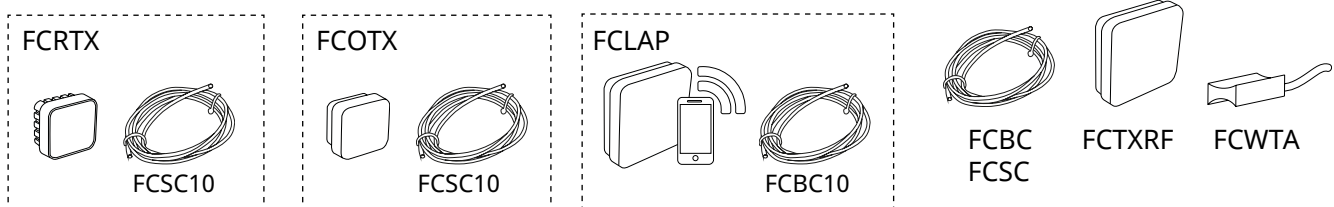

Item number	Type	Description	Dimensions
74694	FCRTX	External room temperature sensor	39x39x23 mm
74695	FCOTX	Outdoor temperature sensor	39x39x23 mm
74699	FCLAP	Local access point for extra wireless sensors and extended range	89x89x26 mm
74718	FCBC05	Extra communication cable, 5 m	5 m
74719	FCBC10	Extra communication cable, 10 m	10 m
74720	FCBC25	Extra communication cable, 25 m	25 m
74721	FCSC10	Extra sensor cable, 10 m	10 m
74722	FCSC25	Extra sensor cable, 25 m	25 m
74703	FCTXRF*	Indoor/outdoor wireless sensor (for FC Smart, FC Pro)	89x89x26 mm
74702	FCWTA	Return water temperature sensor	
74700	FCBAP	Building access point	149x149x43 mm

*The wireless sensor can be set up as outdoor or indoor sensor by a switch inside the sensor.

FC Direct - FCDF

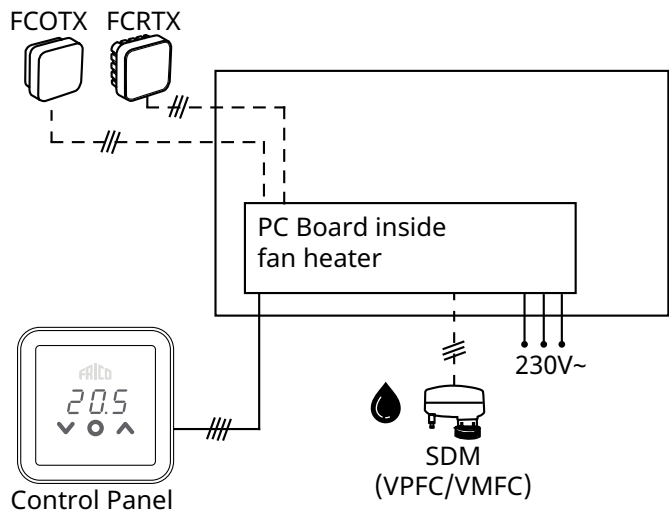
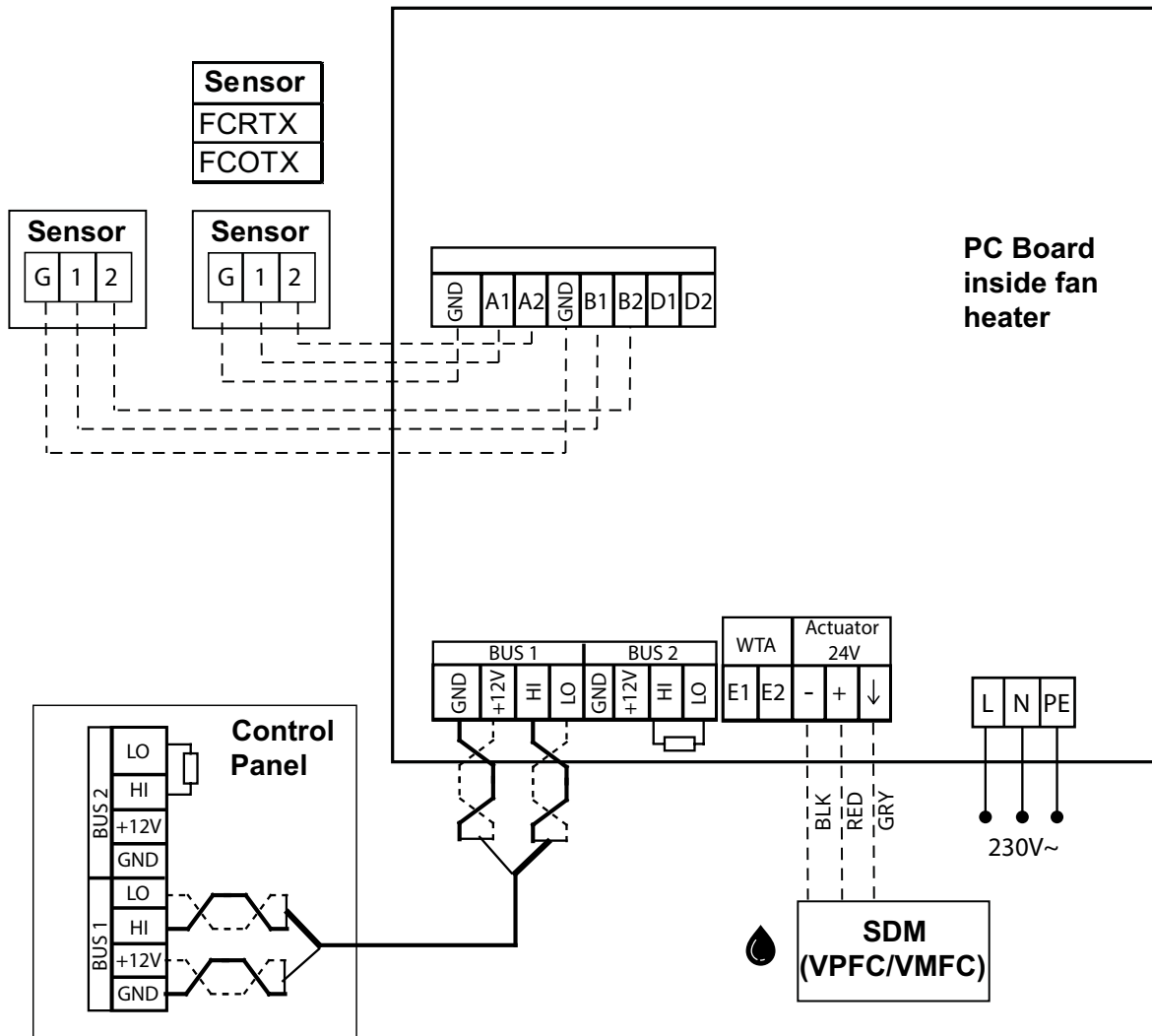

FC Smart - FCSF

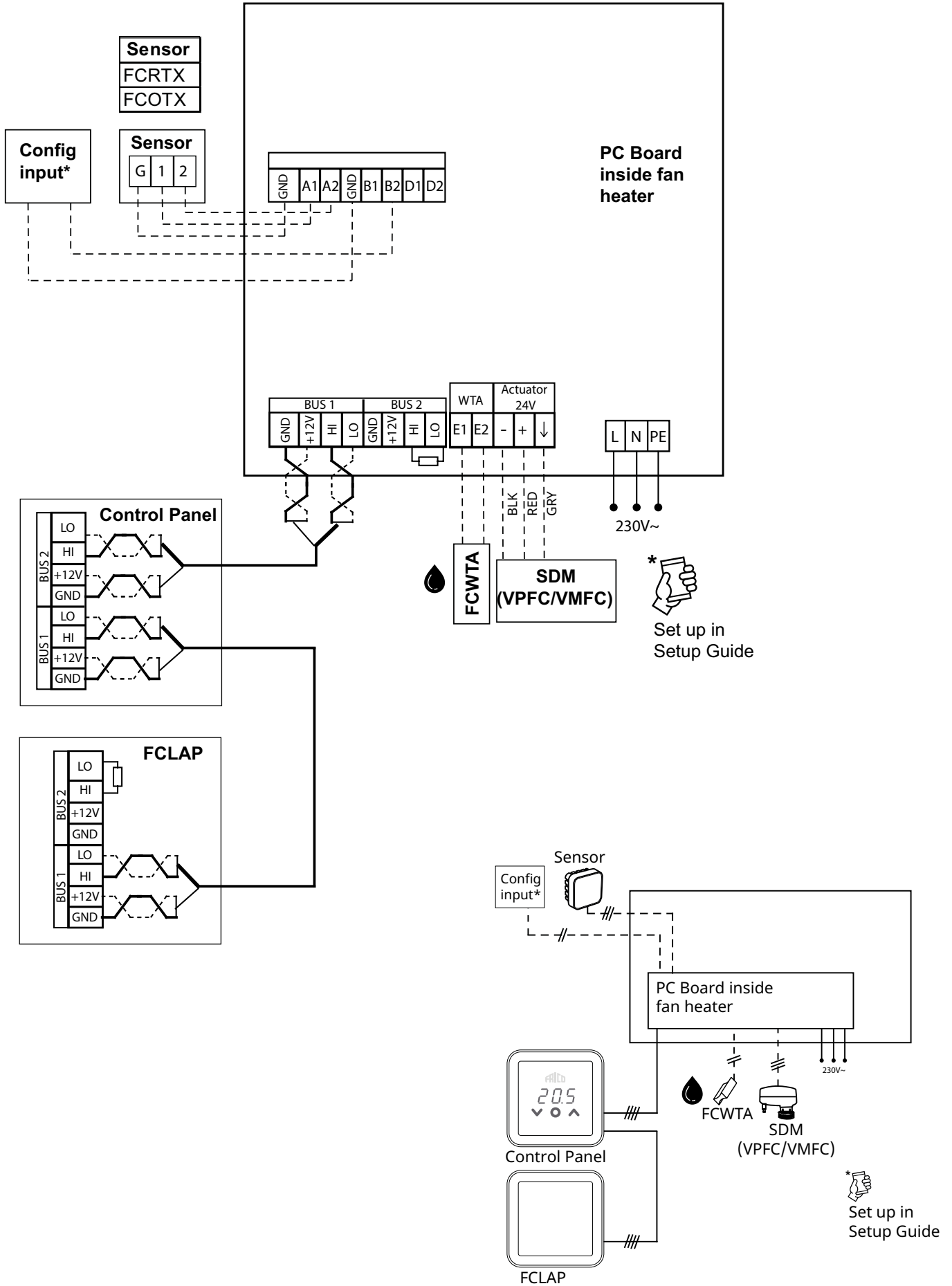

FC Pro - FCPF

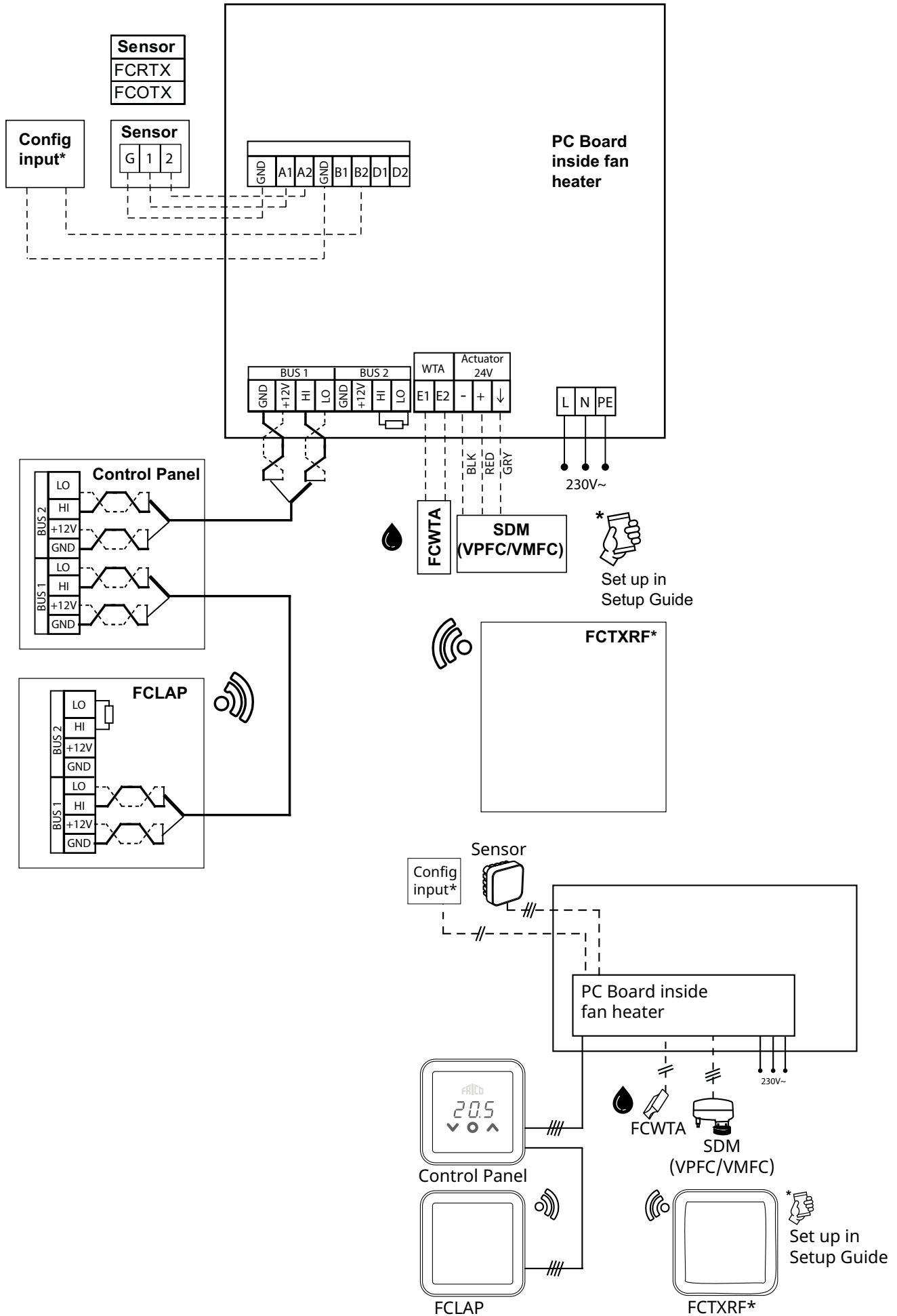

FC Building - FCBF

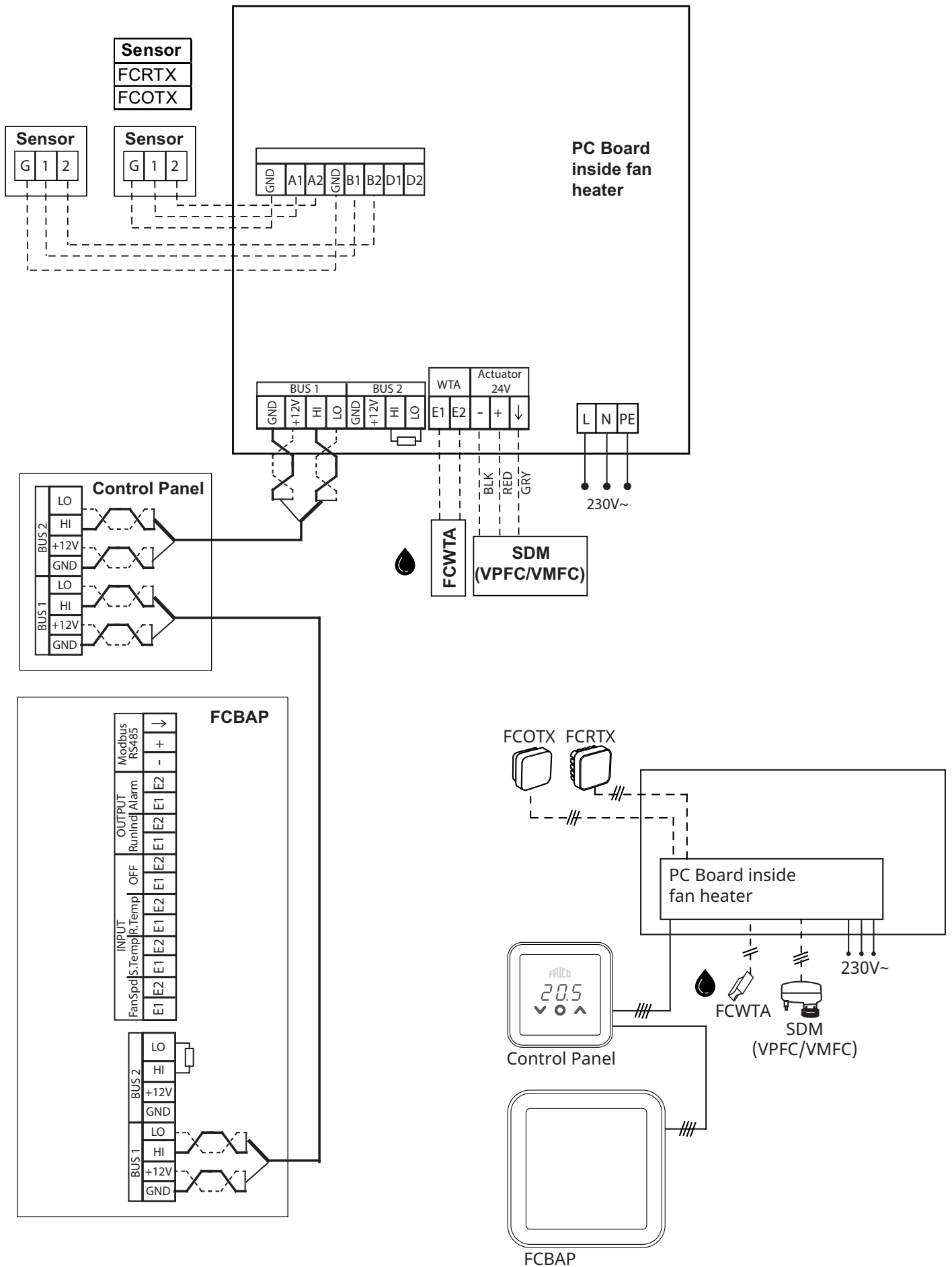

Termination at PC Board

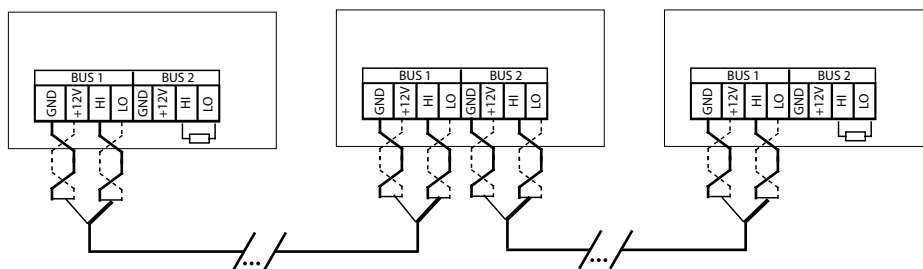

To reduce the risk of interference, the communication BUS should be terminated at each end, i.e. in the units that are located at the start and at the end of the BUS respectively. On delivery, all buses are pre-connected with a 120 Ohm resistor between terminals HI and LO on BUS2. When making further connections, remove the resistor. As an alternative to resistance, the termination switch on the board can be set to the "ON" position.

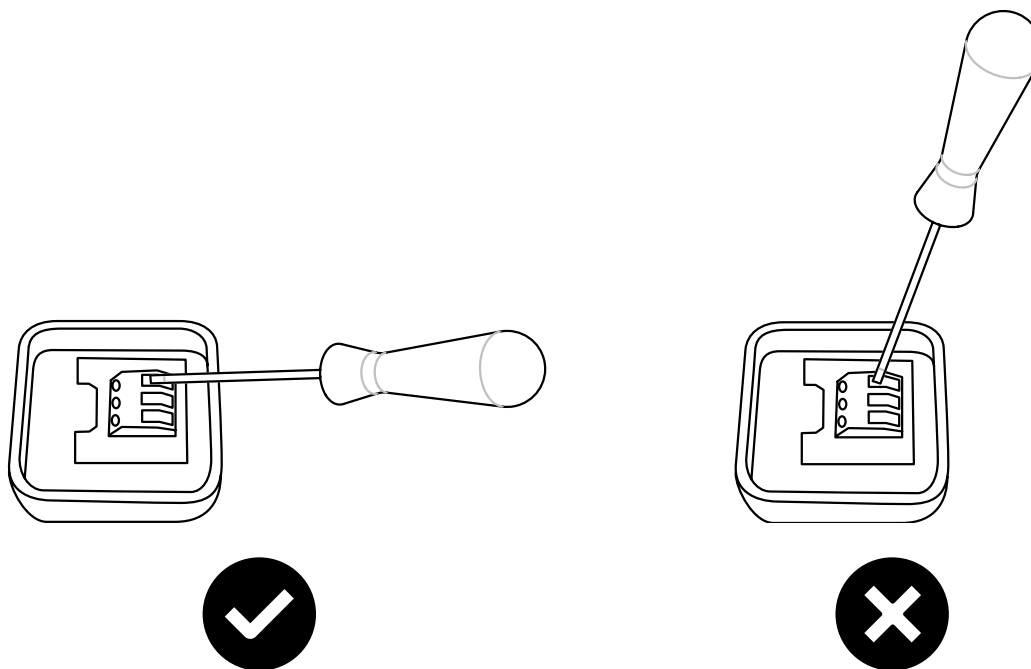

Start up

1. Check that all components and accessories are enclosed.
2. Assemble and connect system, consult wiring diagrams.
3. Power-up the system.
4. The system automatically identifies all components, even when they are added at a later stage.
5. Connecting a new product must always be made with the power off.

System solution

A system consists of a control panel, FCCF, as well as an optional number (1-63) of units (air curtains, fan heaters, access points or control panels) and sensors. The set-point temperature and the fan settings for the system are selected on the control panel.

The control panel houses a built-in temperature sensor which can be used, alternatively the products or zones are fitted with external room temperature sensors that have better sensor positioning for local temperature control.

A. Zone without external room sensors

The control panel's temperature sensor controls all products.

C. Zone with several products with external room sensors connected to each product

External room temperature sensors control each product.

B. Zone with one external room sensor

One external room temperature sensor in the system controls all products.

D. Zone with several products, of which, at least two products have external room sensors and at least one product does not have an external room sensor

External room temperature sensors control each product it is connected to. Products without sensors are controlled by the control panel's temperature sensor.

Heating blocked dependent on outdoor temperature

With outdoor temperature information (FCOTX / FCTXRF / outdoor temperature signal in FCBAP), heating is automatically blocked when the outdoor temperature exceeds 15 °C. The set point can be changed and this function can be deactivated, see Settings.

Control panel

Overview

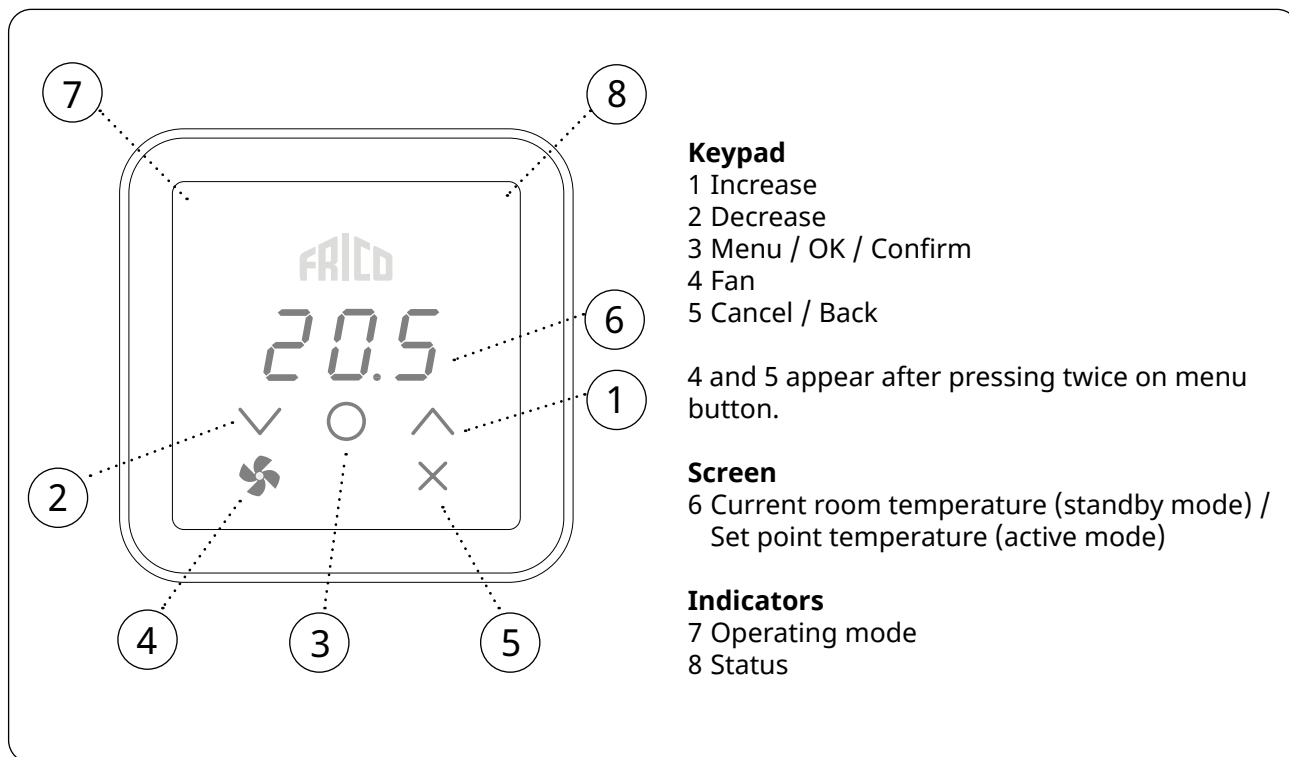

Keypad

- 1 Increase
- 2 Decrease
- 3 Menu / OK / Confirm
- 4 Fan
- 5 Cancel / Back

4 and 5 appear after pressing twice on menu button.

Screen

- 6 Current room temperature (standby mode) / Set point temperature (active mode)

Indicators

- 7 Operating mode
- 8 Status

Indicator Operating Mode (left-hand LED)

Colour (LED)	Operating mode
OFF	Normal mode
White	Comfort mode
White flashing	Comfort mode - temporary
Green	Reduced (night mode)
Green flashing	Reduced (night mode) - temporary
Orange	Timer (activated in app)
Purple	Saving mode (activated in app)
Cyan	Presence mode (activated in app)

During start-up, the text Inlt appears on screen, then the current room temperature is displayed.



When the screen is in standby mode, the light intensity is reduced. Pressing any button will simply display the set point temperature.

The FC control is delivered with preset values. The preset set point temperature is 21 °C and can be easily adjusted using the up/down arrows.

Indicator Status (right-hand LED)



Colour (LED)	Status
White	Heat on
OFF	Heat off
Red flashing	Alarm
Purple	Heating blocking

Display lock

Press and hold (2 sec)	Quick command
 + 	Display lock on/off



The app FRICO CONTROL is available for both iOS and Android.

Fan menu

-  Press twice to activate keypad and hidden buttons.
-  Press and hold for 2 seconds.





Home screen

-  Browse between the menu options.
-  Confirm
or
-  Exit without saving



See the table below for the possible choices.

User menu

-  Press to activate keypad.
-  Press and hold for 2 seconds.



Home screen

-  Browse between the menu options.
-  Confirm
or
-  Exit without saving

See the table on the following page for the possible choices.

Fan menu

Menu options	Functions	Default settings	Description
FAnH	Maximum fan speed in Auto mode.	100 or 3 (100% or step 3)	Increase/decrease with up/down arrow. Confirm with OK.
FAnL	Minimum fan speed in Auto mode.	0	Increase/decrease with up/down arrow. Confirm with OK.
tFAn	Thermostat also controls fan. Fan runs continuously or only when heating.	On	In Auto fan mode; "On" = Fan is off when there is no need for heat "Off" = Fan runs at set "minimum fan speed" (FAnL), when there is no need for heat. In Manual fan mode; "On" = Fan is off when there is no need for heat. "Off" = Fan always runs at the set fan speed, regardless if there is need for heat or not.

User menu

Menu options	Functions	Default settings	Description
dAtE	For week program. Set the following: - year - month - day - time (00:00)	-	Increase/decrease with up/down arrow. Confirm each step with OK.
tHi	For week program. Set the desired room temperature (set point temperature) for comfort mode.	21 °C	Increase/decrease with up/down arrow. Confirm with OK.
tLo	For week program. Set the desired room temperature (set point temperature) for reduced mode.	18 °C	Increase/decrease with up/down arrow. Confirm with OK.
Prog	Weekly program, see separate section.	(off) (function not activated)	Switch between (OFF) and P1-P9 with up/down arrow. Confirm with OK.
HEAt	Switch heating on/off.	On (on)	Switch between (On) and (OFF) with up/down arrow. Confirm with OK.
AL A	Display active alarm.	-	Switch between alarms with up/down arrow. To see the serial number for an alarm, press OK. If no alarm: no A.
AL H	Display alarm history.	-	Switch between alarms with up/down arrow. To see the serial number for an alarm, press OK. If no alarm: no A.
OFF	Switch off the system.	-	To switch off the system, select (OFF) using OK. Wait 10 sec. The system is then switched on by pressing OK and selecting (On) with up/down arrow and confirming with OK.
SEt	Change settings, see separate section Settings.	-	
CLr	Factory reset. Resets values to factory settings.	-	Press OK. Select (YES), by keeping OK depressed for 2 seconds (countdown).
LAP	Pairing with local access point. Follow set up guide in mobile app to pair it with the FC system.	-	Press OK. A pairing period of 120 s starts.

Week program

The FC has nine preset weekly programs (P1-P9) and one customized (P0). Customized program is possible via FC Smart and FC Pro through the mobile app.

To activate weekly program, the following must be set in the user menu:

- Date (dAtE)
- Temperature, comfort mode (tHi)
- Temperature, reduced mode (tLo)

The adaptive start function allows the control to learn when it needs to start in order to attain a given set point temperature at a given time of the day in the environment in which it is used. This function can be deactivated (see Settings menu).





Preset programs

	Description	Comfort mode*
P1	Residence	Mon-Fri: 05:30 - 08 17 - 22 Sat-Sun: 07 - 23
P2	Residence, late	Mon-Fri: 06:30 - 10 19 - 23:30 Sat-Sun: 07:30 - 23:30
P3	Residence, short	Mon-Fri: 06 - 09 16 - 23 Sat-Sun: 07 - 23
P4	Residence, day only	Mon-Sun: 06 - 22
P5	Weekend	Fri: 17 - 23 Sat-Sun: 07 - 23
P6	Office	Mon-Fri: 06 - 18
P7	Office, late	Mon-Fri: 09 - 21
P8	Shop, late	Mon-Fri: 09 - 22 Sat-Sun: 09 - 20
P9	Shop	Mon-Fri: 09 - 18 Sat-Sun: 09 - 14



*) Other times: Reduced (night mode)

Setting week programs

Weekly program is selected and activated in User Menu:



-  Press to activate keypad.
-  Press and hold for 2 seconds.
-  Browse to Prog.
-  Confirm

Selection of preset program P0/P1 - P9

-  Select P0/P1-P9.
-  Confirm to start the program.

Temporarily override the weekly program

It is easy to temporarily disregard the set point temperature which is preset in the weekly program.

-  Set the desired temporary set point temperature.
-  Confirm





The temporary set point temperature will apply until the next program step.

Power failure

Note! A power loss longer than 7 days may require an adjustment of time and date. The week program is affected if the clock is not correctly set.



Settings

Settings are changed in User Menu:

-  Press to activate keypad.
-  Press and hold for 2 seconds.
-  Browse to SEt.
-  Confirm



Enter the number for the setting that will be changed using up/down arrows, confirm each digit with OK. See table.

-  Select desired value according to table.
-  Confirm



Enter password using up/down arrows, confirm each digit with OK. Password: 1932.

Settings - General

#	Functions	Default settings	Description
438	Daylight saving/summer time and winter time.	1 (function activated)	0 (function not activated) / 1 (function activated) Automatic time change-over.
696	Outlet temperature limit		Sets the desired maximum air outlet temperature.

Settings - Outdoor temperature sensor, requires FCOTX / FCTXRF / outdoor signal from FCBAP

#	Functions	Default settings	Description
374	Outdoor temperature heat blocking	1 (enabled)	0 (disabled) / 1 (enabled) If enabled, the heat is blocked when temperature exceeds the set point #376.
376	Outdoor temperature heat blocking - set point	150 (15.0 °C)	Set point for Outdoor temperature heat blocking in 0.1 °C.

Settings - Water heated fan heater

#	Functions	Default settings	Description
747	Bypass	1 (enabled)	0 (disabled) / 1 (enabled) Allows time controlled or temperature* controlled bleeding. *Requires return water temperature sensor and mobile app.
741	Bypass temperature set point - WTA	300 (30.0 °C)	0-50 °C
760	Return water temperature control	0 (disabled)	0 (disabled) / 1 (enabled) Controls the return water temperature. Requires return water temperature sensor and mobile app.
757	Return water temperature limit	500 (50.0 °C)	15-90 °C Sets the desired maximum return water temperature. Requires return water temperature sensor and mobile app.

Reset alarm

To reset manually, press X for 2 seconds where the serial number for an alarm is displayed (see User Menu). The majority of the alarms reset automatically, once the problem is corrected.

The last four digits of the serial number for the faulty product, can be found on the data label on the outside of each FC component or on the PC-board inside the fan heater.

Troubleshooting

Error code	Cause	Action
A 1	Control panel communication error	<ul style="list-style-type: none"> • Check the connections. • If the alarm persists after resetting, contact Frico.
A 5	Contact lost with one or several units in the system	<ul style="list-style-type: none"> • If the component is removed intentionally, the alarm must be reset manually. See previous page. • Check the connections. • The alarm resets automatically, if the component is detected again. • If the alarm persists after resetting, contact Frico.
A 7	External room temperature sensor fault	<ul style="list-style-type: none"> • Check the connections. • If the alarm persists after resetting, contact Frico.
A 8	Contact lost with external room temperature sensor FCRTX	<ul style="list-style-type: none"> • If the component is removed intentionally, the alarm must be reset manually. See previous page. • Check the connections. • The alarm resets automatically, if the component is detected again. • If the alarm persists after resetting, contact Frico.
A 9	Fault on the control panel's temperature sensor	<ul style="list-style-type: none"> • Check the connections. • If the alarm persists after resetting, contact Frico.
A 10	Incorrect sensor connection	
A 11	Outdoor temperature sensor fault	
A 12	Contact lost with outdoor temperature sensor FCOTX	<ul style="list-style-type: none"> • If the component is removed intentionally, the alarm must be reset manually. See previous page. • Check the connections. • The alarm resets automatically, if the component is detected again. • If the alarm persists after resetting, contact Frico.
A 15	Return water temperature sensor fault	<ul style="list-style-type: none"> • Check the connections. • If the alarm persists after resetting, contact Frico.

Troubleshooting

Error code	Cause	Action
A 16	Contact lost with return water temperature sensor, FCWTA	<ul style="list-style-type: none"> • If the component is removed intentionally, the alarm must be reset manually. See previous page. • Check the connections. • The alarm resets automatically, if the component is detected again. • If the alarm persists after resetting, contact Frico.
A 17	No room temperature sensor in the system	Connect a room temperature sensor or a control panel to the system.
A 18	Overheat alarm electrical	Check the reason for overheating. Make sure that the air inlet is not blocked.
A 19	Frost protection alarm	Ensure that the heating is on and working.
A 20	Frost protection alarm from return water temperature sensor.	
A 21	Contact lost with RF sensor, FCTXRF	Check the batteries. If low, replace them. If the batteries are ok, check the local access point.
A 23	RF sensor out of batteries.	Replace the batteries.
A 25	No water heat	Check the water supply temperature and flow.
A 26	No electrical heat	Check the electrical supply. Check the overheat protection, see manual for the air curtain.
A 27	Filter alarm - timer	Clean the filter. Reset the alarm manually.
A 33	Motor alarm	Determine which fan is not functioning and replace it.
A 37	Parameter error	Contact Frico.
A 38	Outlet sensor missing	Check the sensor connections.
A 39	Inlet sensor missing	

When error codes are displayed, the system continues to operate with the components that are functioning. If all room temperature sensors, including the temperature sensor in the control panel, have lost contact, the system will run at 25% heat output.

If the problems continue, please contact Frico for support.



Main office

Frico AB
Industrivägen 41
SE-433 61 Sävedalen
Sweden

Tel: +46 31 336 86 00
mailbox@frico.se
www.frico.net

**For latest updated information and information
about your local contact: www.frico.net**