



resideo

Centra Linear Valve VDE/VXE/VYE

Small Linear Valves

APPLICATION

These small linear valves are used in combination with small electric linear valve actuators and thermoelectric actuators for the control of hot and/or chilled water for fan coil units and small reheaters/recoolers in electric/electronic temperature control systems.

SPECIAL FEATURES

- Dezincification-resistant yellow brass
- No maintenance work is required
- Wide standardized range of k_{vs} values
- Reduced k_{vs} values in the bypass to facilitate hydronic balancing
- Range of fittings available for different connections (compression, soldered, threaded)
- Compatible with two-piece Conex compression fittings
- Small size allows installation where space is limited
- Long stroke results in a high-quality characteristic
- Soft seat for low leakage rate and high rangeability
- High close-off pressure

TECHNICAL DATA

Media	
Medium:	Water, with max. 50 % glycol
Water quality:	according to VDI 2035
Water temperature:	2...120 °C
Connection/Sizes	
Valve size:	DN15 (G ¹ / ₂ "), DN20 (G ³ / ₄ "), DN25 (G1 ¹ / ₄ ")
Specifications	
Model:	Two-way: VDE Three-way: VXE Three-way with bypass: VYE
Operation:	All models stem up to close, port A to B / AB
Nominal pressure rating:	PN 16
Capacity index (k_{vs}):	See chapter „Flow capacities and close-off pressure ratings“
Close-off pressures:	
Leakage rate:	≤0.02 % of k_{vs}
Port connection:	Conical and flat sealing connections in standard sizes

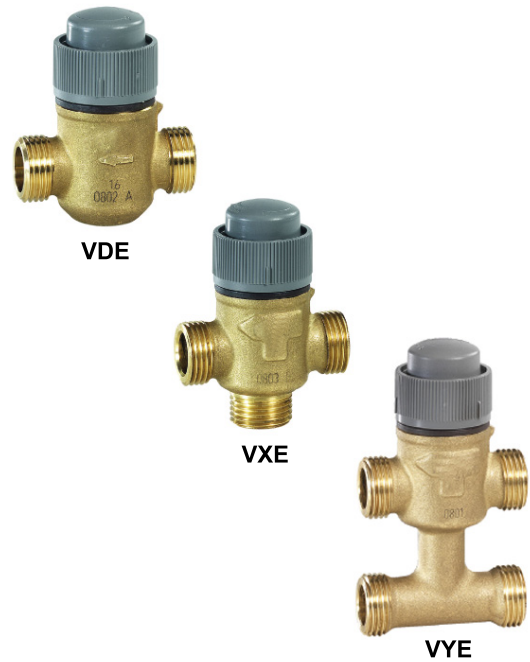

Modulating valves	
Stroke:	6.5 mm
Closure distance:	18 mm
Characteristics:	2-way: - modified equal % 3-way: - A-AB modified equal %; - B-AB linear
ON/OFF valves	
Stroke:	2.5 mm
Closure distance:	14 mm
Snap-on Valves	
Stroke:	2.5 mm
Closure distance:	5 mm

CONSTRUCTION

Overview	Components	Materials
	1 Valve body	Brass resistant to dezincification
	Not depicted components:	
	Stem	Stainless steel
	Plug	Brass, EPDM seals

METHOD OF OPERATION

All types of valves should be mounted in the return flow. If the Δp -values exceed 300 kPa, attention should be paid to the development of noise.

In the case of the 2-way valve, the 3-way valve and the 3-way valve with bypass, the built-in spring produces a closing force on the A-B / A-AB ports.

The valves are supplied with a screwed-on adjustment cap for manual operation and for protection of the stem. If it should become necessary to flush the system, the valve can be opened between approx. 50% and 75% of the rated kVS with the protection cap attached or fully opened via a connected actuator.

This allows the stem to be set up for filling or initial heating/cooling during the building construction phase without the use of a controller or actuator.

The small electric valve actuators as well as the thermoelectric actuators provide automatic control over the opening and closing movement of the valve stem.

Two-way valves

Direction of flow always from port A to port B
Port B: Outlet

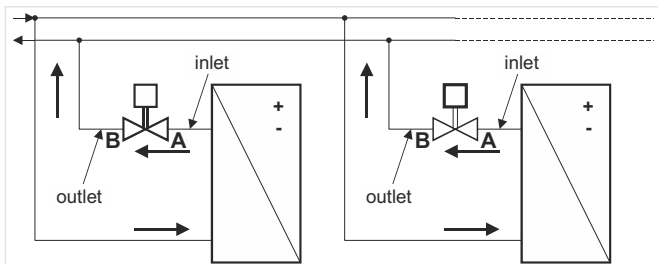

Three-way valves

These valves are preferably used as mixing valves, this means:

Port AB: Total flow outlet

Port A: Controlled flow inlet

Port B: Outlet

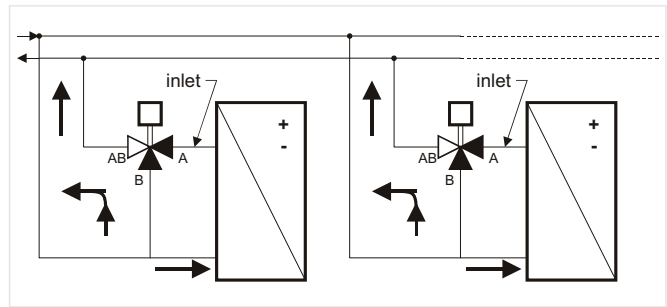

Three-way valves with Bypass

These valves simplify the installation, which is depending on the layout of the pipework, as the bypass pipe is part of the valve. The information for the normal 3-way valves is also valid for this type.

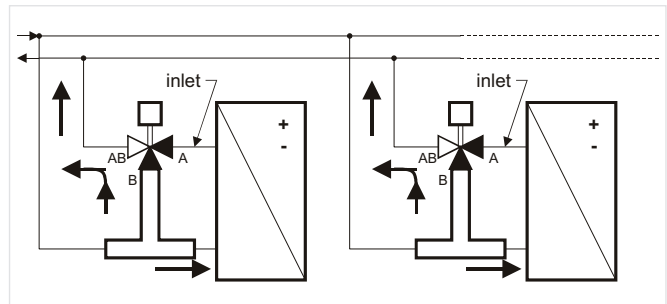

INSTALLATION GUIDELINES

Mounting

When installing the valve care must be taken that the flow direction is correct (see section). The valve must not be mounted with the stem pointing downward.

The adjustment cap must be removed from the valve only when the actuator is fitted. The valve should be installed as stress-free as possible with a tightening torque of 25 to 30 Nm.

The valve is supplied complete with mounting instructions.

Note: Mount the actuator by hand, only. Do not use a tool, as this could result in damage.

Disposal

Statutory regulations and/or environmental protection considerations may require special handling in disposing of the valves

TECHNICAL CHARACTERISTICS

Valve action with MT4/MT8-Series Smart-T Thermal Actuators

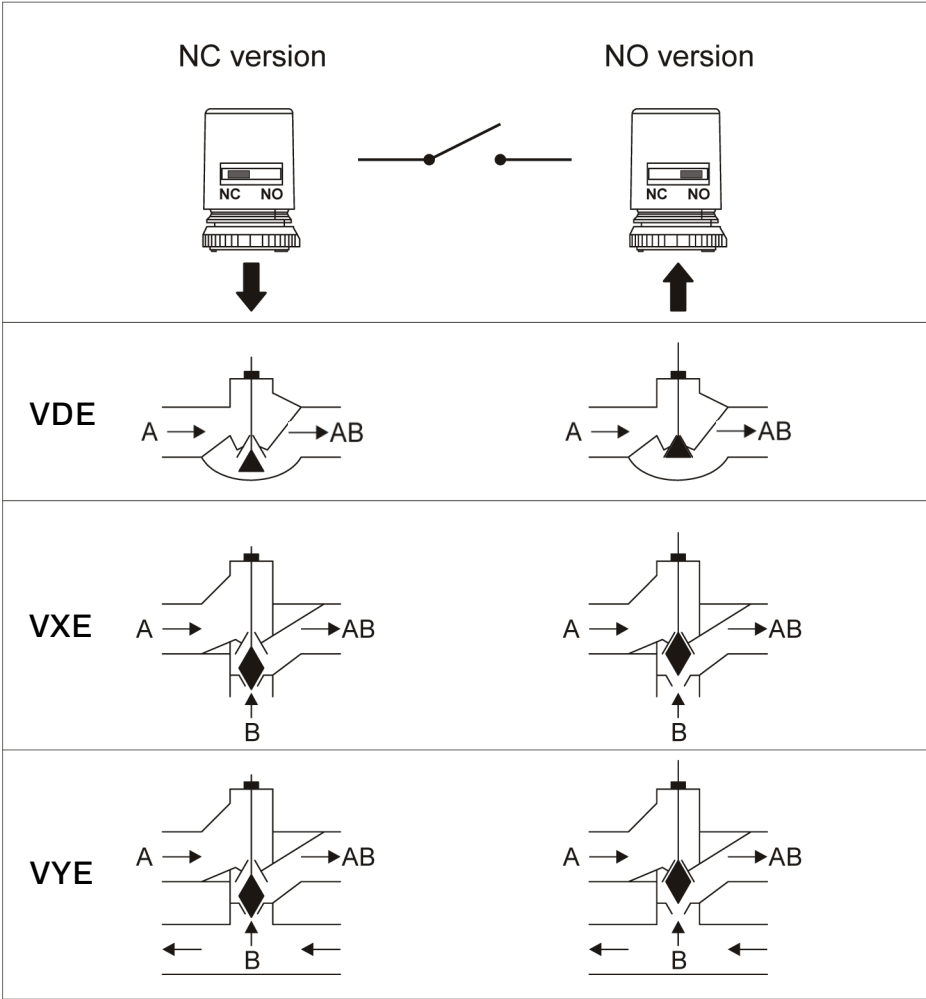

DIMENSIONS

VDE... (2-way)

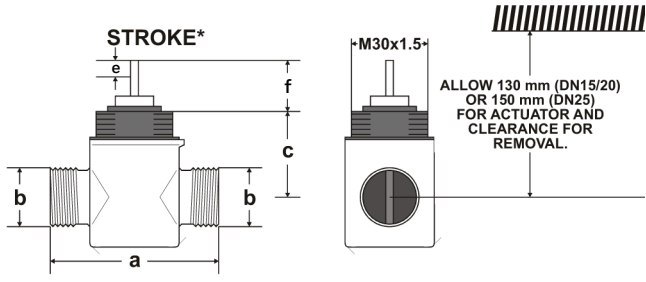
Overview		mod	on-off
	Stroke (e)	6.5	2.5
	Closure distance (f)	18	14

Type	DN	a	b	c
Conical sealing	15	56	G 1/2" A*	32
	20	66	1-1/8 BS84	34
	25	76	G 1 1/4" A*	48
Flat sealing	15	56	G 1/2" A*	32
	20	66	G 3/4" A*	34
	25	76	G 1 1/4" A*	48

VDE...SN (2-way with snap-on)

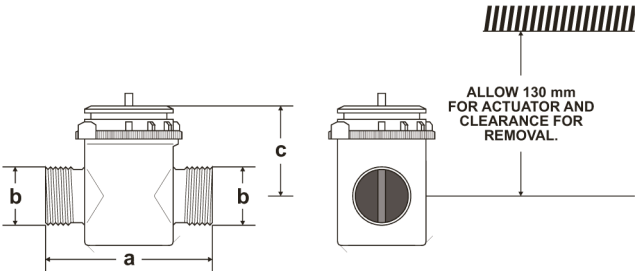
Overview		mod
	Stroke (e)	2.5
	Closure distance (f)	5

Type	DN	a	b	c
Flat sealing	20	66	G 3/4" A*	36.6

VXE... (3-way)

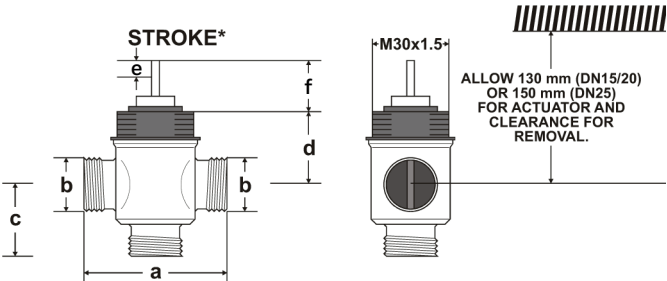
Overview		mod	on-off
	Stroke (e)	6.5	2.5
	Closure distance (f)	18	14

Type	DN	a	b	c	d
Conical sealing	15	56	G 1/2" A*	24.5	32
	20	66	1-1/8 BS84	33	34
	25	76	G 1 1/4" A*	38	48
Flat sealing	15	56	G 1/2" A*	25.5	32
	20	66	G 3/4" A*	33	34
	25	76	G 1 1/4" A*	38	48

VYE... (3-way with bypass)**Overview**

	mod	on-off
Stroke (e)	6.5	2.5
Closure distance (f)	18	14

Type	DN	a	b	c	d
Conical sealing	15	56	G 1/2" A*	40	32
	20	66	1-1/8 BS84	40	34
	25	76	G 1 1/4" A*	62.5	48
Flat sealing	15	56	G 1/2" A*	40	32
	20	66	G 3/4" A*	40	34
	25	76	G 1 1/4" A*	62.5	48

*ISO 228/1

Note: All dimensions in mm unless stated otherwise.

ORDERING INFORMATION

The following tables contain all the information you need to make an order of an item of your choice. When ordering, please always state the type, the ordering or the part number.

Naming key linear valves

VD	E	15	B	1.6	OF
Linear valves	Type of thread	DN (mm)	PN (bar)	k _{VS} -value	Special (optional)
VD = 2 way valves small	E = External	15	B = 16	0.16	OF = On/Off
VX = 3 way valve small		20		0.25	M = Modulating
VY = 3 way valve small with bypass		25		0.40	P = Pressure balanced
				0.63	C/CS = Conical Sealing
				1.0	SN = Snap-On
				1.6	
				2.5	
				4.0	
				5.5	
				6.3	
				8.0	

Naming key linear valves accessories

ASV	-CS	-20	-O	-F
Accessories for V&A	Connection set	DN (mm)	Fitting type	Sealing type
ASV= Accessories for V&A	CS= Connection set	15	F = CONEX Fitting	F = Flat
		20	S = Soldered	C = Conical
		25	O = Outer thread	

Flow capacities and close off pressure ratings**VDE Valves (2-way valves)**

DN	K _{vs} A-B	Type	Stroke	Close-off pressure	Pressure balanced	OS-No.
Two way valves modulating with conical sealing						
15	0.16	MOD	6.5	600 kPa		VDE15B0.16MCS
15	0.25	MOD	6.5	600 kPa		VDE15B0.25MCS
15	0.40	MOD	6.5	600 kPa		VDE15B0.4MCS
15	0.63	MOD	6.5	600 kPa		VDE15B0.63MCS
15	1.0	MOD	6.5	600 kPa		VDE15B1.0MCS
15	1.6	MOD	6.5	300 kPa		VDE15B1.6MCS
15	2.5	MOD	6.5	100 kPa		VDE15B2.5MCS
20	2.5	MOD	6.5	150 kPa		VDE20B2.5MCS
20	4.0	MOD	6.5	50 kPa		VDE20B4.0MCS
25	6.3	MOD	6.5	250 kPa	•	VDE25B6.3MPC
25	8.0	MOD	6.5	250 kPa	•	VDE25B8.0MPC
Two way valves modulating with flat sealing						
15	0.16	MOD	6.5	600 kPa		VDE15B0.16M
15	0.25	MOD	6.5	600 kPa		VDE15B0.25M
15	0.40	MOD	6.5	600 kPa		VDE15B0.4M
15	0.63	MOD	6.5	600 kPa		VDE15B0.63M
15	1.0	MOD	6.5	600 kPa		VDE15B1.0M
15	1.6	MOD	6.5	300 kPa		VDE15B1.6M
15	2.5	MOD	6.5	100 kPa		VDE15B2.5M
20	2.5	MOD	6.5	150 kPa		VDE20B2.5M
20	4.0	MOD	6.5	50 kPa		VDE20B4.0M
25	6.3	MOD	6.5	250 kPa	•	VDE25B6.3MP
25	8.0	MOD	6.5	250 kPa	•	VDE25B8.0MP
Two way valves on-off with flat sealing						
15	1.0	ON-OFF	2.5	600 kPa		VDE15B1.0OF
15	1.6	ON-OFF	2.5	300 kPa		VDE15B1.6OF
15	2.5	ON-OFF	2.5	150 kPa		VDE15B2.5OF
20	2.5	ON-OFF	2.5	200 kPa		VDE20B2.5OF
20	2.5	ON-OFF, Snap on*	2.5	200 kPa		VDE20B2.5OFSN
20	4.0	ON-OFF	2.5	100 kPa		VDE20B4.0OF
25	4.0	ON-OFF	2.5	200 kPa	•	VDE25B4.0OFP
20	4.0	ON-OFF, Snap on*	2.5	200 kPa		VDE20B4.0OFSN
25	5.5	ON-OFF	2.5	200 kPa	•	VDE25B5.5OFP

* To be used directly with MT4/MT8 thermoelectric actuator without adapter because of integrated Snap-On connection

VXE Valves (3-way valves)

DN	K _{vs}		Type	Application	Stroke	Close-off pressure	Pressure balanced	OS-No.
	A-AB	B-AB						
Three way valves modulating with conical sealing								
15	0.25	0.16	MOD	MIX	6.5	600 kPa		VXE15B0.25MCS
15	0.40	0.25	MOD	MIX	6.5	600 kPa		VXE15B0.4MCS
15	0.63	0.40	MOD	MIX	6.5	600 kPa		VXE15B0.63MCS
15	1.0	0.63	MOD	MIX	6.5	600 kPa		VXE15B1.0MCS
15	1.6	1.0	MOD	MIX	6.5	300 kPa		VXE15B1.6MCS
15	2.5	1.6	MOD	MIX	6.5	100 kPa		VXE15B2.5MCS
20	2.5	1.6	MOD	MIX	6.5	150 kPa		VXE20B2.5MCS
20	4.0	2.5	MOD	MIX	6.5	50 kPa		VXE20B4.0MCS
25	6.3	4.0	MOD	MIX	6.5	250 kPa	•	VXE25B6.3MPC
25	8.0	5.5	MOD	MIX	6.5	250 kPa	•	VXE25B8.0MPC
Three way valves modulating with flat sealing								
15	0.25	0.16	MOD	MIX	6.5	600 kPa		VXE15B0.25M
15	0.40	0.25	MOD	MIX	6.5	600 kPa		VXE15B0.4M
15	0.63	0.40	MOD	MIX	6.5	600 kPa		VXE15B0.63M
15	1.0	0.63	MOD	MIX	6.5	600 kPa		VXE15B1.0M
15	1.6	1.0	MOD	MIX	6.5	300 kPa		VXE15B1.6M
15	2.5	1.6	MOD	MIX	6.5	100 kPa		VXE15B2.5M
20	2.5	1.6	MOD	MIX	6.5	150 kPa		VXE20B2.5M
20	4.0	2.5	MOD	MIX	6.5	50 kPa		VXE20B4.0M
25	6.3	4.0	MOD	MIX	6.5	250 kPa	•	VXE25B6.3MP
25	8.0	5.5	MOD	MIX	6.5	250 kPa	•	VXE25B8.0MP
Three way valves on-off with flat sealing								
15	1.0	0.63	ON-OFF	MIX/DIV	2.5	600/200 kPa		VXE15B1.0OF
15	1.6	1.0	ON-OFF	MIX/DIV	2.5	300/200 kPa		VXE15B1.6OF
15	2.5	1.6	ON-OFF	MIX/DIV	2.5	150 kPa		VXE15B2.5OF
20	2.5	1.6	ON-OFF	MIX	2.5	200 kPa		VXE20B2.5OF
20	4.0	2.5	ON-OFF	MIX	2.5	100 kPa		VXE20B4.0OF
25	4.0	2.5	ON-OFF	MIX	2.5	200 kPa	•	VXE25B4.0OFP
25	5.5	3.5	ON-OFF	MIX	2.5	200 kPa	•	VXE25B5.5OFP

VYE Valves (3-way valves with bypass)

DN	K _{vs}		Type	Application	Stroke	Close-off pressure	Pressure balanced	OS-No.
	A-AB	B-AB						
Three way valves with bypass modulating with conical sealing								
15	0.40	0.25	MOD	MIX	6.5	600 kPa		VYE15B0.4MCS
15	0.63	0.40	MOD	MIX	6.5	600 kPa		VYE15B0.63MCS
15	1.0	0.63	MOD	MIX	6.5	600 kPa		VYE15B1.0MCS
15	1.6	1.0	MOD	MIX	6.5	300 kPa		VYE15B1.6MCS
15	2.5	1.6	MOD	MIX	6.5	100 kPa		VYE15B2.5MCS
20	2.5	1.6	MOD	MIX	6.5	150 kPa		VYE20B2.5MCS
20	4.0	2.5	MOD	MIX	6.5	50 kPa		VYE20B4.0MCS
25	6.3	4.0	MOD	MIX	6.5	250 kPa	•	VYE25B6.3MPC
25	8.0	5.5	MOD	MIX	2.5	250 kPa	•	VYE25B8.0MPC
Three way valves with bypass modulating with flat sealing								
15	0.40	0.25	MOD	MIX	6.5	600 kPa		VYE15B0.4M
15	0.63	0.40	MOD	MIX	6.5	600 kPa		VYE15B0.63M
15	1.0	0.63	MOD	MIX	6.5	600 kPa		VYE15B1.0M
15	1.6	1.0	MOD	MIX	6.5	300 kPa		VYE15B1.6M
20	2.5	1.6	MOD	MIX	6.5	100 kPa		VYE15B2.5M
20	2.5	1.6	MOD	MIX	6.5	150 kPa		VYE20B2.5M
25	4.0	2.5	MOD	MIX	6.5	50 kPa		VYE20B4.0M
25	6.3	4.0	MOD	MIX	6.5	250 kPa	•	VYE25B6.3MP
25	8.0	5.5	MOD	MIX	6.5	250 kPa	•	VYE25B8.0MP
Three way valves with bypass on-off with flat sealing								
15	1.0	0.63	ON-OFF	MIX/DIV	2.5	600/200 kPa		VYE15B1.0OF
15	1.6	1.0	ON-OFF	MIX/DIV	2.5	300/200 kPa		VYE15B1.6OF
15	2.5	1.6	ON-OFF	MIX/DIV	2.5	150 kPa		VYE15B2.5OF
20	2.5	1.6	ON-OFF	MIX	2.5	200 kPa		VYE20B2.5OF
20	4.0	2.5	ON-OFF	MIX	2.5	100 kPa		VYE20B4.0OF
25	4.0	2.5	ON-OFF	MIX	2.5	200 kPa	•	VYE25B4.0OFP

Overview associated actuators

Operation	Valve stroke	Control signal				
		230 V AC, On/Off	24 V AC/DC, On/Off	230 V AC, Floating	24 V AC, Floating	24 V AC, 0/2...10V
On/Off	2.5 mm	MT4-230...NC/NO	MT4-024...NC/NO			
Modulating	6.5 mm	MT8-230...NC/NO M5410L1001 M4450A1009	MT8-024...NC/NO M5410C1001 M8450A1000	M6410L2023 M6410L4029	M6410C2023 M6410C4029 M7410C1007	M7410E1002 M7410E2026 M7410E4022

Accessories

	Description	Dimension	Part No.
	MT4 Actuator thermoelectric		
	4.0 mm effective stroke, 90N, on/off	24 V AC	MT4-024-NO
		24 V AC	MT4-024-NC
		230 V	MT4-230-NO
		230 V	MT4-230-NC
	MT8 Actuator thermoelectric		
	6.0 mm effective stroke, 90N, on/off	24 V AC	MT8-024-NO
		24 V AC	MT8-024-NC
		230 V	MT8-230-NO
		230 V	MT8-230-NC
	M5410 Actuator fast motorized		
	Note: Closes when power fails		
	6.5 mm effective stroke, 100N, on/off	24 V AC	M5410C1001
		230 V	M5410L1001
	M4450A Small linear thermoelectric Actuator		
	6.5 mm effective stroke, on/off	230 V	M4450A1009
	M8450A Small linear thermoelectric Actuator		
	6.5 mm effective stroke, on/off	24 V AC	M8450A1000
	M6410 Actuator 3-point		
	6.5 mm effective stroke, 180N, floating	24 V AC	M6410C2023
			M6410C4029
		230 V	M6410L2023
			M6410L4029
	M7410C Actuator 3-point		
	6.5 mm effective stroke, 180N, floating	24 V AC	M7410C1007
	M7410E Actuator 0/2 - 10 V		
	6.5 mm effective stroke, 180N, modulating, depending on model with manual adjustment and auxiliary switch	24 V AC	M7410E1002
			M7410E2026
			M7410E4022

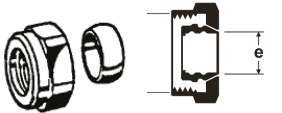
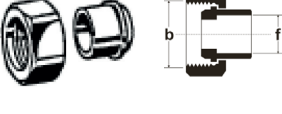
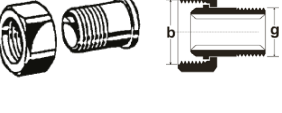
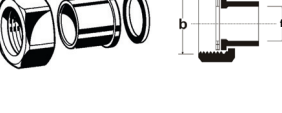
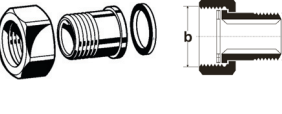
	ASV-CS-xx-F-C Conical connection set Consisting of one union nut and one ferrule, compression connection	$b = G^{1/2}$, $e = 15 \text{ mm}$	DN15	ASV-CS-15-F-C
		$b = 1^{1/8} \times 14 \text{ BS } 84$, $e = 22 \text{ mm}$	DN20	ASV-CS-20-F-C
	ASV-CS-xx-S-C Conical connection set Consisting of one union nut and one solder bush, soldering connection	$b = G^{1/2}$, $f = 12 \text{ mm}$	DN15	ASV-CS-15-S-C
		$b = 1^{1/8} \times 14 \text{ BS } 84$, $f = 15 \text{ mm}$	DN20	ASV-CS-20-S-C
	ASV-CS-xx-O-C Conical connection set Consisting of one union nut and one tailpiece, external thread	$b = G^{1/2}$, $g = R^{3/8}"$	DN15	ASV-CS-15-O-C
		$b = 1^{1/8} \times 14 \text{ BS } 84$, $g = R^{1/2}"$	DN20	ASV-CS-20-O-C
		$b = G1^{1/4}$ $g = R1"$	DN25	ASV-CS-25-O-C
	ASV-CS-xx-S-F Flat connection set Consisting of one union nut, one solder bush and one gasket, soldering connection	$b = G^{1/2}$, $f = 12 \text{ mm}$	DN15	ASV-CS-15-S-F
		$b = G^{3/4}$, $f = 15 \text{ mm}$	DN20	ASV-CS-20-S-F
	ASV-CS-xx-O-F Flat connection set Consisting of one union nut, one tailpiece and one gasket, external thread	$b = G^{1/2}$, $g = R^{3/8}"$	DN15	ASV-CS-15-O-F
		$b = G^{3/4}$, $g = R^{1/2}"$	DN20	ASV-CS-20-O-F
		$b = G1^{1/4}$, $g = R1"$	DN25	ASV-CS-25-O-F

Note: VDE needs two connection sets, VXE needs three connection sets, VYE needs four connection sets



Manufactured for
and on behalf of
Pittway Sàrl, Z.A., La Pièce 4
1180 Rolle, Switzerland

For more information
homecomfort.resideo.com/europe
Ademco 1 GmbH, Hardhofweg 40,
74821 MOSBACH, GERMANY
Phone: +49 6261 810
Fax: +49 6261 81309