

Operating instructions

Date 0628

Dcontrol

Type PKDT / PKDM



English

Controllers for voltage-regulated 3-phase motors

Applications:

- Speed controller for fans in refrigeration, air-conditioning and clean-room engineering
- Pressure / temperature controller for refrigeration engineering



Manufacturer: ZIEHL-ABEGG AG
Heinz-Ziehl-Straße
D-74653 Künzelsau
Phone: +49 (0) 7940 16-0
Fax: +49 (0) 7940 16-504
e-mail: info@ziehl-abegg.de
internet: <http://www.ziehl-abegg.de>

PKDT5: Software D1238A Part-No. 00162653 from version 10

PKDM5..80.: Software D1197A Part-No. 00162616 from version 07 (with two sensor inputs)

From year of construction: 2006

Contents

1. General..... 4

2. Safety measures..... 4

3. General description 5

3.1 Scope of applications 5

3.2 Technical data 5

3.3 Versions 6

3.4 Power decrease for increased ambient temperatures 7

4. Installation 8

4.1 Mounting..... 8

4.2 Minimum space requirement..... 8

4.3 Outdoor installation 8

4.4 Installation location for agriculture..... 8

4.5 Temperature influences during commissioning 8

4.6 Residual-current-operated protective device 8

4.7 Potential at control voltage connections 8

4.8 Employment in the IT Net..... 8

5. Electrical connections 9

5.1 Mains connection 9

5.2 Adjustment to specific mains conditions 9

5.3 Motor connection..... 9

 5.3.1 Motor feeder cable 9

5.4 Motor noise..... 10

5.5 Motor protection 10

5.6 Special function only for PKDM...: Motorstart with maximum output voltage „Hard start function “ 10

5.7 Signal cable (sensor cable)..... 10

5.8 Enable ON / OFF..... 11

5.9 Signal connection or sensor connection (Analog IN1, Analog IN2)..... 11

5.10 External speed setting (operation as a speed regulating rheostat) 11

 5.10.1 Inverting setting signal 11

 5.10.2 Operation with second setting signal at input „E2“ (special function only for PKDM..) 11

5.11 Sensor Connection (operation as a P-controller)..... 12

 5.11.1 Operation with a second sensor signal at input E2 for dual circuit condensers (only for PKDM..) 12

5.12 Switch over control function at Digital IN 2 (only for operation as P-controller)..... 12

5.13 Fault indications 12

5.14 Voltage supply for external equipment..... 12

5.15 Output voltage (0-) 10 V (needed only as required) 12

6. General settings and operating elements 13

6.1 Programming the operating mode (speed controller / P- controller)..... 13

6.2 Controls 14

7. Settings for operation	15
7.1 Settings for operation as a speed controller	15
7.1.1 Setting of output voltage via potentiometer „SET“	15
7.1.2 Setting of output voltage via external signal or external potentiometer	15
7.1.3 Min. speed „n-min“ (minimum output voltage or basic speed).....	15
7.1.4 Max. speed „n-max“ (derating) and Cos ϕ -adjustment.....	15
7.1.5 Operation with two variable output voltages (2 steps).....	16
7.2 Settings for operation as a controller	17
7.2.1 Adjusting the nominal value via potentiometer “Set”	17
7.2.2 Adjusting the control range via potentiometer “Pband”	18
7.2.3 Min. speed „n-min“ (minimum output voltage or basic speed).....	18
7.2.4 Max. speed „n-max“ (derating) and Cos ϕ -adjustment.....	18
7.2.5 Setting with pressure / temperature refrigerant medium table for Type PKDT <u>5</u> with MBG-30I.....	19
7.2.6 Setting with pressure / temperature refrigerant medium table for type PKDM <u>5</u> .80 with MBG-30I.	20
7.2.7 Minimum airflow rate (Minimum air shutdown active / not active)	21
7.2.8 Reversed control function (Act>Set = n+)	21
8. Faults and rectification of these	22
8.1 Mains fault	22
8.2 Temperature fault	22
8.3 Motor fault	22
8.4 Sensor-signal faults.....	23
8.5 If controller doesn't work correctly	23
9. Enclosure.....	24
9.1 Connection diagram PKDT <u>5</u>	24
9.2 Connection diagram PKDM <u>5</u> .80.....	25
9.3 Connection suggestion for several motors with motor protection unit type STDT.....	26
9.4 Dimension sheet.....	27

1. General

Before installation and start-up, read this manual carefully to ensure a correct use.

Attention! Hazardous area!



Danger owing to electric current or voltage!!



Important information!



- The copyright for these operating instructions remains to ZIEHL-ABEGG AG, Künzelsau.
- The device is constructed in accordance with the current state of technology and the recognised safety regulations. Nevertheless, use of the device is associated with dangers which may cause death or injury to users or third parties as well as damage to the system and other objects.
- The device is intended exclusively for the tasks listed in the order confirmation. Any other or extraordinary uses of the device (unless previously agreed by contract) are considered contrary to regulations. The manufacturer is not liable for damages resulting from incorrect use. The operating company alone bears the risk.
- To allow for future developments, construction methods and technical data given are subject to alteration. We do not accept any liability for possible errors or omissions in the information contained in data, illustrations or drawings provided.
- The controllers are packed ex factory to suit the transport method previously agreed. Always use the original packaging materials when transporting the controller. When transporting by hand, ensure that personnel possess the strength required to lift and carry the device. Avoid shocks and impacts to the device. Check the packaging and controller for damage.
- Store the controller in its original packaging in a dry and weather-proof room. The device must not be exposed to extreme heat and low temperatures.

2. Safety measures

In the case of a malfunction or a failure of the equipment check all functions with alarms in order to prevent injury to persons or property. Note possibility of back-up operation.

If used in intensive animal environments, any malfunctions in the air supply must be detected as soon as possible to prevent the development of a life-threatening situation for the animals. The design and installation of the system must comply with local regulations and directives. In Germany these include DIN VDE 0100, the animal protection and the keeping of working animals ordinance and the pig-keeping ordinance etc.

Also note the instructions of AEL, DLG, VdS.

- Apart from the operating instructions and the obligatory regulations to be followed by users relating to accident prevention, the recognised technical regulations must also be observed (safety and branch-related work as per UVV, VBG, VDE, etc.).
- These devices are potentially dangerous if they are used incorrectly by untrained personnel or are not implemented according to their specified use.
- **Work on electric components/modules may only be carried out by trained electricians in accordance with electro-technical regulations (e.g. EN 60204, DIN VDE 0100/0113/0160).**
- The contractor or owner must also ensure that the electric systems and equipment are operated and maintained in accordance with electro-technical regulations. The owner is obliged to ensure that the device are operated in perfect working order only.
- **It is forbidden to carry out work on electrically live parts. The rating given in the enclosure for the device when open is IP00! It is possible to inadvertently touch components carrying hazardous voltages!**
- During operation, the device must be closed or installed in a control cabinet.
- Fuses may only be replaced by new ones and must not be repaired or bypassed. The data for the maximum line fuse are to be considered absolutely (☞ Technical data). Use only fuses specified in schematic diagrams.
- The safe isolation from the supply must be checked using a two-pole voltage detector.
- Any faults detected in the electric system/modules/operating equipment must be corrected immediately. If these faults are not corrected, the device/system is potentially very dangerous. The device/system must therefore not be operated when it is faulty.

3. General description

3.1 Scope of applications

The controlling device as described is intended for infinitely variable speed settings in voltage-regulated 3-phase motors for driving fans and pumps.

3.2 Technical data

The name plate data refer to a maximum ambient temperature of 40°C. (with internal semiconductor fuses) or 50°C (without internal semiconductor fuses).

version: housing IP54, internal semiconductorfuses								
Type	Part.-No.	Rated current for 40°C {1} [A]	max. line fuse {2} [A]	internal semiconductor fuse {3} (Part-No.)	Heat dissipation approx. [W]	Weight [kg]	Line voltage	
PKDT5	304555	5	10	FF20A 6x32mm Pack of 10 fuses : 349026	25	2.4	3~ 415 V, (-18 % .. +6 %) 50/60 Hz	
PKDT5*	304556	5				2.4		
PKDM5	304558	5				2.4		
PKDM10	304559	10	16	FF30A 10x38mm pack of 10 fuses: 349027	50	2.8	3~ 208 - 415 V, (-10 % bis +6 %) 50/60 Hz	
PKDM12	304570	12				3.4		
PKDM15	304560	15				4.7		
PKDM20	305594	20	25	FF30A 10x38mm gRL single fuse 00155984	80	5.7		
PKDM25	305532	25	35	FF50A D02 pack of 10 fuses: 349028	100	12.7		
PKDM35	305533	35	50	FF63AD02 pack of 10 fuses: 349029	150	13.0		
PKDM50	305563	50	63	FF100A NH00 single fuse 00150230	170	19.5		
PKDM80	305564	80	100	FF160 ANH00 single fuse (00089793)	270	20.5		
PKDM20(500V)	305600	20	25	FF30A 10x38mm gRL single fuse 00155984	80	5.7		3~ 208 - 500 V, (-10 % .. +10%) 50/60 Hz

version: housing IP54, no internal semiconductor fuses							
Type	Part.-No.	Rated current for 50°C {1} [A]	max. line fuse {2} [A]	semiconductor fuse installation on site {4} (Part.-No)	Heat dissipation approx. [W]	Weight [kg]	Line voltage
PKDT5Z	304573	5	10	FF20A 6x32mm pack of 10 fuses : 349026	25	2.4	3~ 415 V, (-18 % .. +6 %) 50/60 Hz
PKDM10Z	304574	10	16		45	2.8	
PKDM12Z	304575	12	16	FF30A 10x38mm pack of 10 fuses: 349027	50	3.35	3~ 208 - 415 V, (-10 % bis +6 %) 50/60 Hz
PKDM15Z	304576	15	20		65	4.7	
PKDM20Z	305597	20	25	FF30A 10x38mm gRL single fuse 00155984	75	5.65	
PKDM25Z	305576	25	35	FF 50 A D02 (fuse kits 349030)	95	12.2	
PKDM35Z	305577	35	50	FF 63 A D02 (fuse kits 349031)	140	13.0	
PKDM50Z	305578	50	63	FF100 A NH00 (fuse kits 349032)	160	19.5	
PKDM80Z	305579	80	100	FF160 A NH00 (fuse kits 349033)	255	20.5	

version: housing IP20 for switch cabinet mounting, no internal semiconductor fuses.							
Type	Part.-No.	Rated current for 50°C {1} [A]	max. line fuse {2} [A]	semiconductor fuse installation on site {4} (Part.-No)	Heat dissipation approx. [W]	Weight [kg]	Line voltage
PKDM25E	305547	25	35	FF 50 A D02 (fuse kits 349030)	95	7.2	3~ 208 - 415 V, (-10 % bis +6 %) 50/60 Hz
PKDM35E	305548	35	50	FF 63 A D02 (fuse kits 349031)	140	7.4	
PKDM50E	305588	50	63	FF100 A NH00 (fuse kits 349032)	160	13.8	
PKDM80E	305589	80	100	FF160 A NH00 (fuse kits 349033)	255	15.4	

* for "mobile application" version, phase failure is deactivated!
 {1} for line voltage 400 V / 50 Hz or 500 V / 50Hz for special version PKDM..(500V)
 {2} Max. supply side line fuse according to DIN EN 60204-1 classification VDE0113 chapter 1
 {3} with internal semiconductor fuse (no line protection)
 {4} semiconductor fuse installation on site recommended. Protection for damages in the case of short-circuits. Not in the scope of supply, as accessories available!

- Maximum cross section for line and motor connection

PKDT5 / PKDM5..20:	2.5 mm ²
PKDM25/35 :	6 mm ²
PKDM25/35 <u>E</u> :	10 mm ²
PKDM50/80 (E) :	35 mm ²

- Stepless controlled output voltage approx. 20-100 % (line voltage)
 Rampup time / Rampdown time for PKDM 5...35: ca. 5 sec
 Rampup time / Rampdown time for PKDM 50/80: ca. 15 sec.
- Minimum motor current
 for PKDT5, PKDM5: 0.2 A
 for PDKM10...80: 0.5 A
- Input resistance for sensor or signal set for the rotational speed:
 - For 0-10 V input: $R_i > 100 \text{ k}\Omega$
 - For 4-20 mA input: $R_i = 100 \Omega$
- Voltage supply e.g. for sensors +24 V $\pm 20 \%$, I_{\max} 120 mA
- Output (0-) 10 V, I_{\max} 10 mA (short-circuit-proof)
 - For function as speed controller: Fixed voltage 10 V for external potentiometer
 - For function as a P-controller: 0-10 V proportional to the regulated output voltage
- Max. permissible ambient temperature depending on version
 - for controller with internal fuses type PKDT.. and PKDM..: 40° C (up to 55° C with derating)
 - for without internal fuses type PKDM..E und PKDM..Z : 50° (up to 55° C with derating)
- Min. permissible ambient temperature 0° C (if mains voltage is not switched off up to -20°C)
- Permissible installation height 0..4000m amsl above 1000 m amsl the rated current is to be reduced by 5% / 1000m
- Permissible rel. humidity 85 %, no condensation
- Interference emission in accordance with EN 61000-6-3
- Interference immunity in accordance with EN 61000-6-2
- Harmonics current EN 61000-3-2
 The units comply with EN 61000-3-2 for a "professional unit". Up to a maximum current of 4 ampere the limits were complied without any qualification.

3.3 Versions

IP 54 for wall mounting

- ◆ PKDT5 Motor protection using TK connection, internal semiconductor fuses
- ◆ PKDT5Z Motor protection using TK connection, semiconductor fuses construction site
- ◆ PKDM.. Motor protection using TK or PTC resistor connection.
- ◆ PKDM..Z Motor protection using TK or PTC resistor connection, semiconductor fuses construction site

IP20 for switch cabinet mounting

- ◆ PKDM..E Motor protection using TK or PTC resistor connection, semiconductor fuses construction site

3.4 Power decrease for increased ambient temperatures

The unit's maximum permissible ambient temperature is depending on version 40° C, or 50°C. Up to that temperature a load of the quoted rated current is possible. The removal of heat in the unit due to power dissipation is dependent on the ambient temperature, so the maximum load has to be reduced if the ambient temperature is higher than 40° C or 50°C! For each degree higher the load has to be reduced approx.. 2.2%.

The median (measured 24 h) has to be 5° C below the max. ambient temperature. Pay attention of the unit's power dissipation and their possible effects on the ambient temperature if the unit is mounted in a switch cabinet (☞ General description: Technical data)!

Maximum load for ambient temperatures higher 40°C for versions with internal fuses

Type	Part-No.	Rated current for 40°C	max. current load for 45°C	max. current load for 50°C	max. current load for 55°C
PKDT5	304555	5	4,5	3,9	3,4
PKDT5	304556	5	4,5	3,9	3,4
PKDM5	304558	5	4,5	3,9	3,4
PKDM10	304559	10	8,9	7,8	6,7
PKDM12	304570	12	10,7	9,4	8,0
PKDM15	304560	15	13,4	11,7	10,1
PKDM20	305594	20	17,8	15,6	13,4
PKDM20(500V)	305600	20	17,8	15,6	13,4
PKDM25	305532	25	22,3	19,5	16,8
PKDM35	305533	35	31,2	27,3	23,5
PKDM50	305563	50	44,5	39,0	33,5
PKDM80	305564	80	71,2	62,4	53,6

Maximum load for ambient temperatures higher 50°C for versions without internal fuses

Type	Part-No.	Rated current for 50°C	max. current load for 55°C
PKDT5Z	304573	5	4,5
PKDM10Z	304574	10	8,9
PKDM12Z	304575	12	10,7
PKDM15Z	304576	15	13,4
PKDM20Z	305597	20	17,8
PKDM25Z	305576	25	22,3
PKDM25E	305547	25	22,3
PKDM35Z	305533	35	31,2
PKDM35E	305548	35	31,2
PKDM50Z	305563	50	44,5
PKDM50E	305563	50	44,5
PKDM80Z	305564	80	71,2
PKDM80E	305589	80	71,2

4. Installation

4.1 Mounting

- Assemble the device on a clean and stable base. Do not distort during assembly! Use the appropriate mounting devices for proper installation of the unit!
- Do not mount equipment on vibrating base!
- Use the appropriate fixing equipment. The plastic washers must be installed between the screw heads and the housing for models with mounting holes on the inside of the housing!
- Install the device away from transport routes. However, ensure however that the device is still easily accessible!
- Depending on the housing model cut off necessary cable inlets respectively to the cable diameter. Or alternative use cable inlet for cable glands. Metal sheet housings are supplied with stoppers. Any cable ducts openings not used must be sealed!
- Protect the device from direct exposure to sunlight!
- The device is designed for vertical installation (cable inlet down). A horizontal or reclined installation is only permissible after consultation with the manufacturer.
- **Be sure to observe proper heat dissipation (☞ Technical data, "heat dissipation")** 

4.2 Minimum space requirement

In order to ensure sufficient ventilation of the device, clearance on all sides of at least 50 mm has to be maintained to the housing walls, switch cabinet doors, wiring ducts, etc. The same clearance applies to the installation of several devices next to each other (☞ illustration).

When installing several devices on top of each other, the danger of reciprocal heating exists. This layout is only then permissible when the air suctioned from the upper unit does not become warmer than the permissible ambient temperature (☞ Technical data). I.e., a correspondingly larger clearance or thermal shielding is required.

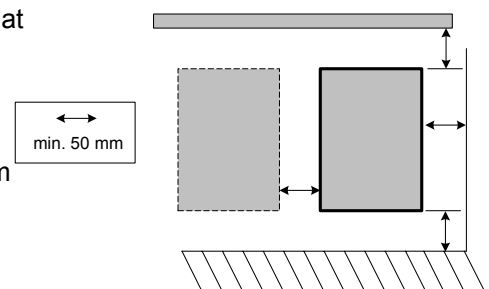

4.3 Outdoor installation

Outdoor installation is possible up to -20°C when the controller supply is not switched off. Installation must be protected from the effects of weather as much as possible, including protection from direct sunlight!

4.4 Installation location for agriculture

In order to avoid damage caused by ammoniac vapours (NH₃), the controller shall not be installed in the stable, but rather in an outhouse wherever possible.

4.5 Temperature influences during commissioning

Avoid condensation in the controller and hence functional faults attributable to condensation by storing the controller at room temperature!

4.6 Residual-current-operated protective device

Owing to possible leakage currents occurring when the device is switched on, it is advisable to use short-time-delayed current-operated circuit-breakers. This prevents any triggering by mistake. Plants without neutral conductor connection ☞ Electrical connections: Mains connection.

4.7 Potential at control voltage connections

The control voltage connections (<50 V) relate to the joint GND potential (Exception: Relay contacts are potential free). There is a potential separation between the control voltage connections and the earthed conductor.

It must be ensured that the maximum external voltage at the control voltage connections cannot exceed 50V (between „GND“ terminals and „PE“ earthed conductor).

If necessary, a connection to the earthed conductor potential can be established, install bridge between “GND” terminal and the “PE” connection (terminal for screening ☺)

4.8 Employment in the IT Net

In the IT net the neutral point of voltage supply is not grounded; in the case of a short-circuit between a phase (e.g. "L1") and protective grounding "PE" becomes the protective grounding potential = "L1".

In order to ensure a trouble free enterprise in this case,

1. the "GND" potential of the control ports does not have to be connected with the protective grounding potential,
2. the "N" lead must not be connected.

As consequence of the connection between "GND" potential of the control ports with protective grounding potential, the following must be considered (exception relay contacts floating):

1. Only with lines for mains voltage and environment are suitable attach.
2. Attach over suitable isolating amplifiers.

5. Electrical connections

5.1 Mains connection

Power from the mains is connected to terminals: PE, L1, L2, L3, and N. Here, it must be strictly observed that the mains voltage lies within the allowable tolerance specifications (☞ General description: Technical data and nameplate affixed to the side).

The neutral conductor connection “N” is only for the leakage current’s reduction. It is of no significance for the function of the device. The connection is not applicable for power supply networks without a neutral conductor. Since higher leakage currents may arise by this across the protective-cable connection “PE”, unwanted triggering by mistake may occur in systems with FI protection circuits.



If the neutral conductor “N” is not connected and the “PE” connection is interrupted, touching can result in dangerously high leakage currents. In this case, EN 50178 Section 5.3.2.1 for devices with leakage current above 3.5 mA must be observed.

(Employment in the IT network ☞ 4.8)

The supply voltage has to correspond to DIN EN 50160!

5.2 Adjustment to specific mains conditions

◆ Fixed 60 Hz assignment

Upon connection, the mains frequency (50 or 60 Hz) is automatically detected and used to trigger ignition of the thyristors. If, in exceptional cases, a 60 Hz mains frequency can not be clearly identified, fixed assignment can be necessary (mains failure, as device operates at 50 Hz if 60 Hz is not detected).

By dipswitch S1 No. 6
ON (up) = 60 Hz fix
OFF (down) = automatic detection

◆ Deactivating phase monitoring

The device has built in phase monitoring (☞ Faults and troubleshooting: Mains failure). For special applications (e.g. unstable mains supply, phase position other than 120° on a soft generator or for transformer operation) this can be disconnected after consultation with Ziehl-Abegg. The motor is thus no longer protected by TWO PHASE OPERATION (observe Motor protection chapter).

By dipswitch S1 No. 8
ON (up) = phase monitoring activ
OFF (down) = phase monitoring deactivated

5.3 Motor connection

The motor leads are connected to the terminals: PE, U, V, W. Several fans can be connected to the controller-the maximum total current of all motors (maximum rated current for electronic control of the voltage) must not exceed the current rating for the controller.

If the maximum control current for the electronic voltage control is not known, then allowance for an increase in the motor nominal current must be made. Typical is this for 2- and 4-pole motors at approx. 25 %, for 6-pole motors at approx. 20 %, for 8- and 10-pole motors at approx. 15 % and higher pole motors at approx. 5 %.

For the control of motors made by other manufacturers (not Ziehl-Abegg), the control characteristics and the maximum current for electronic regulation of the voltage should be enquired from the manufacturer.



It is recommended that a separate motor protection unit be foreseen for each fan.

For motors with thermistors: e.g. type U-EK230E
For motors with thermal contacts: e.g. type STDT 16 (E) or AWE-SK

(☞ Enclosure: Circuit suggestion for several motors with motor protection unit type STDT)

5.3.1 Motor feeder cable



The applicable standard for radiating interference is EN 61000-6-3.

A unshielded motor feeder cable is required for compliance with the standard.

5.4 Motor noise

Motor noise can occur when fans are controlled using electronic voltage controllers (Phase cutting = series “P...”). Such noise can be system-dependently perceived as a disturbance. This noise is relatively low for fast-running fans where the noise from the air is high. The noise from motors in slower-running fans where the noise from the air is less, can be dominated by resonance in the lower speed ranges.

For systems where noise is critical, we recommend using our **Fcontrol** series frequency converters with integrated sinusoidal filter

5.5 Motor protection

◆ **PKDT5**

The motor can be protected by connecting the thermal contacts (PKDT: I = motor protection using IK connection).



- **It shall be observed for motors with built-in PTC thermistors that these cannot be connected to the “TK” terminals (type PKDT). A separate triggering unit (e.g. type U-EK230E) is required in this case for the PTC thermistor.**
- **When several motors are connected ensure that the thermal contacts are always connected in series.**

◆ **PKDM5..80**

The motor can be protected by connecting the thermal contacts or PTC resistor (PKDM: M = motor protection using TK or PTC resistor connection).



- **When several motors are connected ensure that the thermal contacts or PTC resistors are always connected in series. A maximum of six individual thermistors (DIN 44081 or DIN 44082) may be connected in series to a single device. Depending on the motor type, at least two or three individual sensors are built in.**
- **Monitoring of motors in “Ex“ zones is not permissible. For systems of this type, an additional posistor tripping unit is required, with disconnection via a separate motor protection circuit.**

The unit switches off when a connected thermal contact or PTC resistor has tripped the circuit (interruption between both TK terminals). The unit then remains switched off. The fault-indicating relay opens (terminals 11-12 bridged) the red LED for motor fault illuminates, the green LED for operating goes off. The unit starts up again once the drive has cooled down by switching the mains voltage OFF and then ON again or by enable ON/OFF (terminal “D1”).



- **An outside voltage may never be connected to the terminals “TK”!**
- **The internal motor protection does not function if a bypass circuit has been realised. In this case and as well as other precautions, an additional thermal contact protective device is necessary.**

5.6 Special function only for PKDM..: Motorstart with maximum output voltage „Hard start function “

For types PKDM “Hard start function” can be activated for the connected fans.”Hard start” function means to force the controller to generate for approx. 10 seconds max. voltage (100%) ignoring any control signal.

Afterwards the output voltage adjusts itself to the given or over the control amplifier calculated value.

For operation as P-controller the „Hard start function“ works also by switching over the control function (“Heating” / “Cooling”).

By dipswitch S1 No. 5

ON (up) = with “hard start function”

OFF (down) = no „Hardstart function“ (**factory setting**)

After switching on of the mains voltage on the output voltage rises during the firmly programmed run-up time to the given value

5.7 Signal cable (sensor cable)

Pay attention to sufficient distance from powerlines and motor wires to prevent interferences.

The control cables may not be longer than 30 m. Screened control cables must be used when the cable length is longer than 20 m. When using a screened cable, the screen must be connected to the protective conductor at one end, i.e. only at the control unit (as short and of as low an inductance as possible!).

5.8 Enable ON / OFF

Enable ON / OFF (electronic disconnection) and reset after motor fault via potential free contact, terminals „D1“-„D1“.

- ◆ Device ON with contact closed
- ◆ Device OFF with contact open (“Fault“ relay K1 not released, terminals 11-14 bridged)

Display for disconnection: Green LED flashes



No disconnection (isolation) when turned off, in accordance with VBG4 §6.

5.9 Signal connection or sensor connection (Analog IN1, Analog IN2)

PKDT5 has one analog input (Analog IN 1).

PKDM.. controllers have 2-analog inputs (Analog IN1 & Analog IN 2)

Input 1 (Analog IN1) terminals „E1“ and „GND“

Input 2 (Analog IN2) terminals „E2“ and „GND“

Ensure correct polarity when connecting; a 24 V DC power supply is integrated for sensors. For sensors in two-wire-technology (4-20 mA signal), the connection is made on the +24 V and „E1“ or „E2“ terminals (the GND terminal is omitted). The connection is independent of the programmed operating mode and from the sensor signal employed. Place the internal plug (jumper) for the external default signal in the correct position, factory setting 4..20 mA.

(Jumper for Input signal ☞ Pos 6).

5.10 External speed setting (operation as a speed controller)

The signal for selecting the speed is connected to the terminals “E” (E1) and “GND”; be sure to observe correct polarity. The maximum length of the connecting cable shall be 30 m (screened).

- ◆ Setting signal **4-20 mA** jumper **E1.1 and E1.2 down inserted**
- ◆ Setting signal **0-20 mA** jumper **E1.1 and E1.2 not inserted**
0-20 mA signal is possible by connecting in an external **resistor (499 Ω / 0.25 W)** in parallel between the terminals “E” and “GND”.
- ◆ Setting signal **0-10 V** or external potentiometer jumper **E1.1 and E1.2 not inserted**
An external speed setting is possible by using a 10 kΩ potentiometer connected to the terminals “A” (+10 V) and GND with pick-off at terminal “E” (E2).

5.10.1 Inverting setting signal

With switch 1 to Dipswitch S1 (not inverted by the factory)

Switch 1 OFF = setting signal not inverted (0-10 V, 0-20 mA, 4-20 mA)

Switch 1 ON = setting signal inverted (10-0 V, 20-0 mA, 20-4 mA)

5.10.2 Operation with second setting signal at input „E2“ (special function only for PKDM..)

An input for a second default signal is activated over the switch 7 on Dipswitch S1.

Place the internal jumper “E2.1” and “E2.2” depending on signal in correct position (see input “E1”).

- Setting signal not inverted

By operation with a second signal the controller works automatically at the higher level of the two analog inputs (E1 or E2).

- Setting signal inverted

By operation with a second signal the controller works automatically at the lower level of the two analog inputs (E1 or E2).

5.11 Sensor Connection (operation as a P-controller)

The signal from the sensor for detection of the actual value is connected to the terminals "E" or "E1" and "GND", for sensor in two-wire-technology (output 4-20 mA) to terminals "E" (E1) and "24 V". Be sure to observe correct polarity. The maximum length of the connecting cable shall be 30 m (screened).

There is an integrated power supply (+24 V, I_{\max} 120 mA) for e.g., a pressure sensor of the type DSF2-25 or MBG-30I.

Sensors with the following standard signals may be connected depending on the programming of the controller:
0-10 V, 4-20 mA, KTY10-6 (PTC temperature sensor).

5.11.1 Operation with a second sensor signal at input "E2" for dual circuit condensers (only for PKDM..)

The entrance for a second sensor signal is activated over the switch 7 on Dipswitch S1.

Place the internal jumper "E2.1" and "E2.2" depending on signal in correct position (see jumper for input "E1").

By operation with a second sensor signal automatic regulation at the higher level of the two analog inputs (selection amplifier integrated e.g. for dual circuit condensers).

5.12 Switch over control function at Digital IN 2 (only for operation as P-controller)

For operation as P-controller an external switch over of control function is possible. When terminals "D2"- "D2" are bridged, the device works with the opposite function than the set with Dipswitch 1 (☞ 7.2.7).

5.13 Fault indications

An external fault indicator is available over the potential-free contacts of the built-in relay (contact load-carrying capacity 5 A, 250 V AC). The relay is energized if the controller is on mains supply, i.e. terminals "11" and "14" are bridged. If there is a fault the relay is de-energized, i.e. terminals "11" and "12" are bridged.

- By switching off via enable ON/OFF (terminal "D1") the relay is not de-energized.

- By sensor failure (only in P-control operation) message only via the LEDs (yellow + green), the relay is not de-energized.

A fault is indicated by:

A phase failure*, blown semiconductor fuse*, excessively high temperature at the unit, a defective controller-internal voltage supply, overheating by the motor (thermal contacts or thermistor connected).

(* for "mobile application" version, there is no error message for phase failure or blown semiconductor fuse!)

5.14 Voltage supply for external equipment

There is an integrated power supply e.g. for pressure sensors of the type DSF2-25 / MBG-30I.

Terminals	+ 24 V	Output voltage tolerance ± 20 %.
		Max. on-load current 120 mA

In the event of overload or short circuit (24 V \leftrightarrow GND), the control voltage cuts out and hence switches off the control unit.

Reconnection after solving failure cause:

- ◆ PKDT5: switch off line voltage and on again after cooling down the transformers.
- ◆ PKDM... incl. multifuse: automatic switch on.

5.15 Output voltage (0-) 10 V (needed only as required)

For operation as a P-controller (☞ basic settings):

Output voltage 0-10 V, I_{\max} 10 mA (terminals „A"/"GND") is approximately proportional to the regulated output voltage. This can be used for example, for a "slave controller" or for a valve-positioning motor.

For operation as a speed controller (☞ basic settings):

Fixed 10 V, I_{\max} 10 mA voltage for maintaining the speed from an external potentiometer.

6. General settings and operating elements

6.1 Programming the operating mode (speed controller / P- controller)

It is possible to use the device as a **speed controller** or as a **P-controller**. Selection of the function must first be made by setting the internal **dipswitch** and **Jumper**.

i **Caution: not under voltage! Observe the safety notices!**
Changed functions become active partly only after renewed switching on the mains voltage !

Factory setting: Operation as P-controller for sensor with 4-20 mA signal at "E1"!

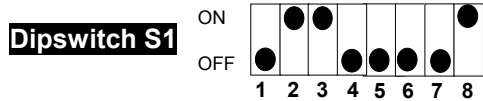

Jumper E2.1 and E2.2 for input E2
 input for additional functions (only PKDM)

Jumper E1.1 and E1.2 for input E1
 Standard input

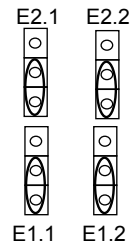

General setting for:							
Speed controller			P-Controller				
Input 0-10 V (0-20 mA / 4-20 mA and Inverting ⚡ Electrical connections: External speed setting“)			Temperature sensor TF..(KTY10-6)	Pressure sensor 4-20mA DSF../MBG	Pressure sensor 0-10 V		
Dipswitch S1	Function:	Setting:	Function:	Setting:			
1	Signal function	ON = 10-0 V OFF = 0-10 V	Control function	ON = Increasing output voltage for decreasing actual value OFF = <u>Increasing output voltage for increasing actual value</u>			
2	No function	-	Min. air shut down	ON = <u>not activ</u> OFF = <u>activ</u>			
3	Type of control	ON = <u>Internal pot</u> OFF = external pot or 0-10 V	Type of signal (for PKDT5 no function)	OFF	ON = <u>4-20mA</u> OFF = 0-20mA	ON = <u>2-10V</u> OFF = 0-10V	
4	For speed controller	ON	For P-controller	<u>OFF</u>			
Additional functions							
5	Hardstart Function (for PKDT5 no Funktion)	ON = with Hardstart function OFF = <u>no Hardstart function</u>	Hardstart Function (for PKDT5 no Funktion)	ON = with Hardstart function OFF = <u>no Hardstart function</u>			
6	60 Hz assignment	ON = 60 Hz fix OFF = <u>Automatic detection</u>	60 Hz assignment	ON = 60 Hz fix OFF = <u>Automatic detection</u>			
7	Input E2 (for PKDT5 no Funktion)	OFF = <u>input not activ</u> ON = input activ	Input E2 (for PKDT5 no Funktion)	OFF = <u>input not activ</u> ON = input activ			
8	Phase monitoring	ON = <u>phase monitoring activ</u> OFF = phase monitoring deactivated	Phase monitoring	ON = <u>phase monitoring activ</u> OFF = phase monitoring deactivated			
Jumper							
E2.1+E2.2 + E1.1+E1.2	Type of signal	0-10 V both not inserted	Depending on type of sensor	both up inserted	<u>both down inserted</u>	both not inserted	

XXXXXXX = Connector position set at the factory

6.2 Controls

Operation as a speed controller

For operation as a speed controller, the output voltage is set manually by adjusting the built-in potentiometer, by an external potentiometer or external signal (0-10 V).

Setting	Potentiometer
Output voltage 0-100 % (switch S1-3 ON position) (Control by internal potentiometer)	“SET“
No function	“Pband“
Minimum output voltage 0-100 % (basic speed)	“n-min“
Maximum output voltage 0-100 % (speed limiter)	“n-max“

Operation as a P-controller (standard factory setting)

Operation as a P-controller or temperature or pressure (factory setting for the sensor with a 4-20 mA signal).
For operation as a P-controller, the actual value measured by the sensor is compared with the nominal value that has been set. The output voltage and hence the rotational speed of the connected motor automatically change as a function of the parameter settings.

Setting	Potentiometer
Set value 0-100% For temperature control for PKDT5: 0° C to +60° C for PKDM: -25° C to +75° C For pressure control 0-100 % Δ measuring range of pressure sensor	“SET“
Control range 5-30 % (P-component) For temperature control for PKDT5: 4-24 K for PKDM: 5-30 K For pressure control 5-30 % Δ measuring range of pressure sensor	“Pband“
Minimum output voltage 0-100 % (basic speed)	“n-min“
Maximum output voltage 0-100 % (speed limiter)	“n-max“

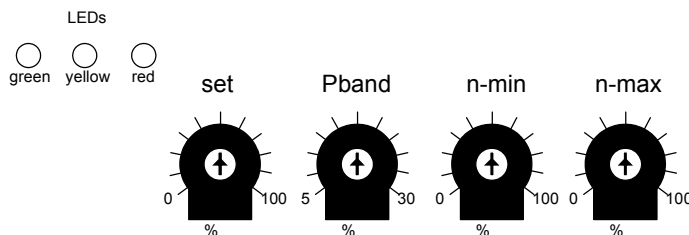

LED indications

Meaning	LED
Normal operation without any faults	Green
Motor fault (interruption at TK terminals)	Red
Line fault (failure by a line phase)	Yellow + red
Interruption / short circuit in sensor line, or sensor actual values outside the measuring range (only for operation as controller)	Yellow + green
Device overheating (measured at internal heat sink)	Red blinking
Line interruption to heat-sink sensor	green + red on and yellow blinking
“D1”-“D1” terminals are not bridged (no enable)	green blinking

7. Settings for operation

7.1 Settings for operation as a speed controller

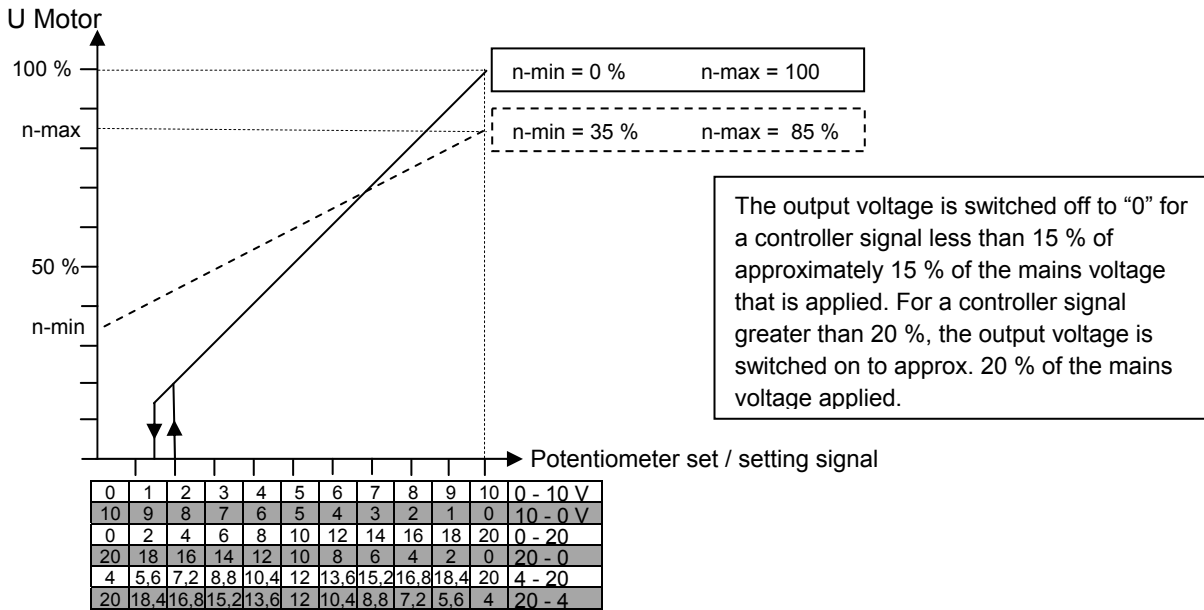

Idealised schematic diagram

7.1.1 Setting of output voltage via potentiometer „SET“

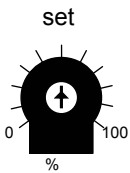

1. Dipswitch S1-3 **ON** position (control by internal potentiometer)
2. Setting the output voltage by the potentiometer "SET" from approx. 0, 20-100 % of the applied mains voltage, or in the range of the settings "n-min" to "n-max".

7.1.2 Setting of output voltage via external signal or external potentiometer

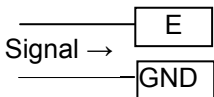

1. Dipswitch S1-3 **OFF** position (control by an external potentiometer).
2. Setting the output voltage by the external signal or by an external potentiometer from approx. 0, 20-100 % of the applied mains voltage, or in the range of the settings "n-min" to "n-max".

7.1.3 Min. speed „n-min“ (minimum output voltage or basic speed)

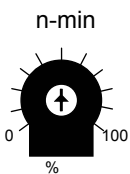

If required setting of a minimum output voltage, e. g. basic speed (minimum airflow rate) of connected fans.

Setting range:

From the counter-clockwise limit = "0" (no "n-min") to 15-100 % (≈ approximately the mains voltage applied).

7.1.4 Max. speed „n-max“ (derating) and Cos φ-adjustment

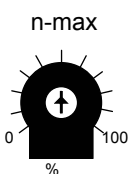

If required setting of a maximum output voltage, e. g. speed limiter.

Setting range:

From the clockwise limit (100 %) to 20 % (≈ approx. 100 % - 20 % of the applied mains voltage).

For a given minimum output voltage to the setting "n-min". For cos φ adjustment, turn "n-max" counter-clockwise such that the maximum output voltage will just be measured (with TRUE-RMS multimeter). This adjustment must be made for maximum output from the fans. All flaps must be opened when using centrifugal fans.



Cos φ adjustment

The output voltage from the unit depends on the inductance of the motor (cos φ). By this, the maximum output voltage can already be reached below the maximum input signal (<10 V / 20 mA). A correction is possible by setting "n-max" (cos φ adjustment).

7.1.5 Operation with two variable output voltages (2 steps)

Switchover between two variable output voltages for the operational mode of external control (Dipswitch S1-3 **OFF** position) is possible by means of external potential-free contact-making.

Step 1 (low speed)

When there is no input signal connected to the input terminal "E" or "E1", then the unit supplies the output voltage set by "n-min".

Step 2 (high speed)

When the terminal "A" (+10V) is connected with the input terminal "E" or "E1", then the unit supplies the output voltage set by "n-max."

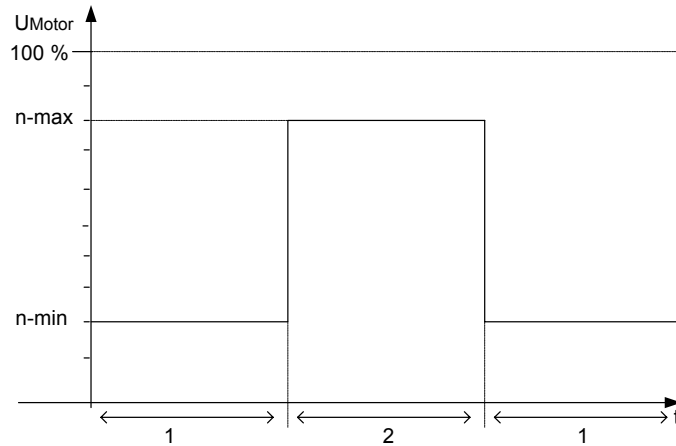
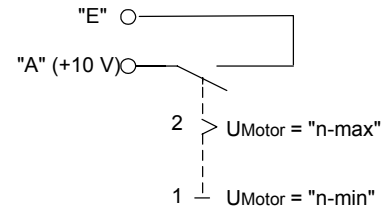

7.2 Settings for operation as a controller

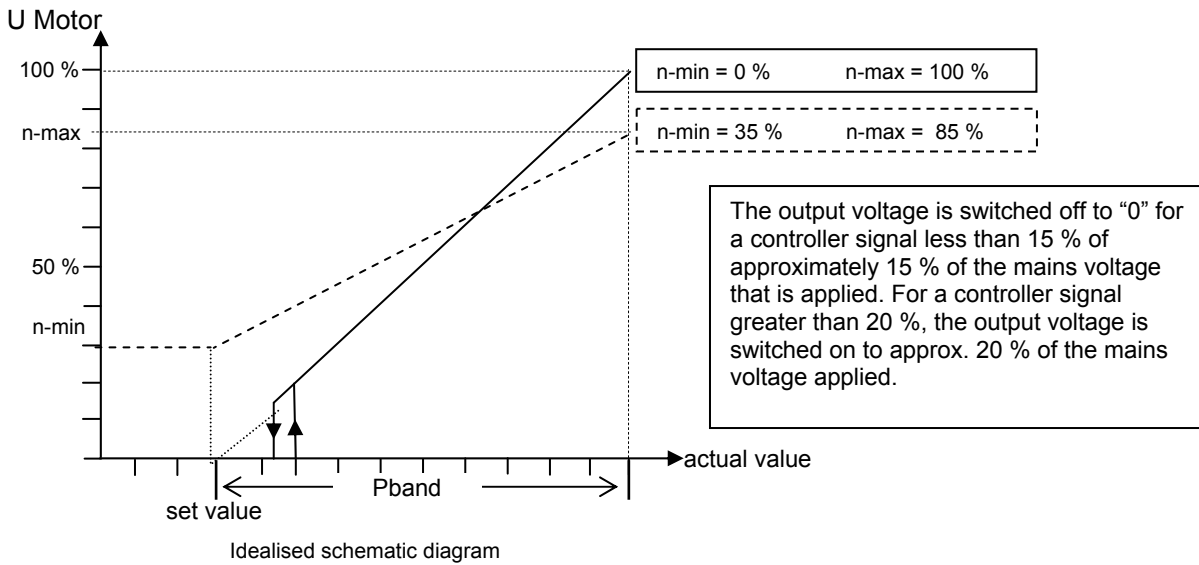

7.2.1 Adjusting the nominal value via potentiometer "Set"

set Set the desired nominal value at the setpoint potentiometer in the range from 0-100 %.

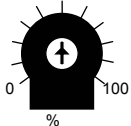

- ◆ At active sensors with 0-10 V or 4-20 mA (factory setting) 0-100 % $\hat{=}$ measuring range of the sensor.

E.g., pressure control with PKDM: Pressure sensor, type MBG-30I (0-30 bar, measuring range 30 bar)
 Setting 50 % $\hat{=}$ 15 bar nominal value

For condensation pressure control at refrigeration technology
 ⚙ Settings for operation: setting with pressure / temperature refrigerant medium table

- ◆ At passive temperature sensor TF.. (KTY10-6)

- PKDT5 0-100 % $\hat{=}$ 0° C ... +60° C (measuring range, i. e. possible operation range 0-80° C)

Set Position [%]	0	5	10	15	20	25	30	35	40	45	50	55	60	65	70	75	80	85	90	95	100
Set temp. [°C]	0	3	6	9	12	15	18	21	24	27	30	33	36	39	42	45	48	51	54	57	60

- PKDM 0-100 % $\hat{=}$ -25° C ... +75° C (measuring range, i. e. possible operation range -25° C ... +75° C)

Set Position [%]	0	5	10	15	20	25	30	35	40	45	50	55	60	65	70	75	80	85	90	95	100
Set temp. [°C]	-25	-20	-15	-10	-5	0	5	10	15	20	25	30	35	40	45	50	55	60	65	70	75

7.2.2 Adjusting the control range via potentiometer “Pband”

The control response can be adjusted to the system conditions with this setting
 - small control range = greater amplification and shorter control times
 - big control range = longer control times and higher controller stability

Pband

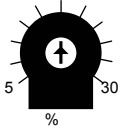

- ◆ At active sensors with 0-10 V or 4-20 mA (factory setting)
 5-30 % $\hat{=}$ 5-30 % of measuring range of the sensor
 Setting range:
 E.g., pressure control with PKDM:
 Pressure sensor, type MBG-30I (0-30 bar, measuring range 30 bar)
 Setting 10 % $\hat{=}$ 3 bar

- ◆ At passive temperature sensor TF.. (KTY10-6)

- PKDT5 5-30 % $\hat{=}$ 4 ... 24 K (5-30 % of device’s measuring range 0-80° C)

Pband [%]	5	10	15	20	25	30
Temperature [K]	4	8	12	16	20	24

- PKDM 5-30 % $\hat{=}$ 5 ... 30 K (5-30 % of device’s measuring range -25 ... +75° C)

Pband [%]	5	10	15	20	25	30
Temperature [K]	5	10	15	20	25	30

n-min

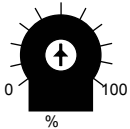

7.2.3 Min. speed „n-min“ (minimum output voltage or basic speed)

If required setting of a minimum output voltage, e. g. basic speed (minimum airflow rate) of connected fans.
 Setting range:
 From the counter-clockwise limit = “0” (no “n-min”) to 15-100 % ($\hat{=}$ approximately the mains voltage applied).

n-max

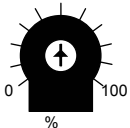

7.2.4 Max. speed „n-max“ (derating) and Cos ϕ -adjustment

If required setting of a maximum output voltage, e. g. speed limiter.
 Setting range:
 From the clockwise limit (100 %) to 20 % ($\hat{=}$ approx. 100 % -20 % of the applied mains voltage).
For a given minimum output voltage to the setting “n-min”. For cos ϕ adjustment, turn “n-max” counter-clockwise such that the maximum output voltage will just be measured (with TRUE-RMS multimeter). This adjustment must be made for maximum output from the fans. All flaps must be opened when using centrifugal fans.



Cos ϕ adjustment
 The output voltage from the unit depends on the inductance of the motor (cos ϕ). By this, the maximum output voltage can already be reached below the maximum input signal (<10 V / 20 mA). A correction is possible by setting “n-max” (cos ϕ adjustment).

7.2.5 Setting with pressure / temperature refrigerant medium table for Type PKDT5 with MBG-30I

i Calculation for relative pressure (differential measurement of pressure relative to ambient pressure)

Set	MBG-30I [bar]	Signal [mA]	R12 [°C]	R13 [°C]	R13b1 [°C]	R22 [°C]	R23 [°C]	R32 [°C]	R114 [°C]	R134a [°C]	R142B [°C]	R227 [°C]	R401 [°C]	R401A [°C]	R401B [°C]	R402 [°C]	R402A [°C]	R402B [°C]	R404A [°C]	R407A [°C]	R407B [°C]	R407C [°C]	R500 [°C]	R502 [°C]	R503 [°C]	R507 [°C]	R717 [°C]
0%	0,00	4,0	-30,09	-81,99	-58,14	-41,11	-82,44	-52,53	3,45	-26,43	-10,07	-17,58	-27,05	-29,21	-28,97	-47,59	-47,59	-45,46	-46,36	-39,47	-43,49	-37,31	-33,80	-45,54	-88,64	-46,51	-33,59
5%	1,13	4,6	-10,88	-66,52	-40,93	-23,68	-68,20	-36,11	24,89	-8,54	10,56	1,29	-8,95	-11,22	-11,01	-30,41	-30,41	-28,16	-29,03	-22,62	-26,71	-20,36	-15,20	-27,85	-74,02	-29,62	-17,46
10%	2,25	5,2	1,55	-56,57	-29,80	-12,47	-59,11	-25,72	38,73	2,92	23,68	13,55	2,63	0,33	0,48	-19,45	-19,45	-17,12	-17,97	-11,92	-16,03	-9,58	-3,26	-16,49	-64,68	-18,75	-7,23
15%	3,38	5,8	11,06	-48,98	-21,28	-3,93	-52,23	-17,89	49,32	11,62	33,60	22,97	11,42	9,12	9,21	-11,15	-11,15	-8,75	-9,60	-3,82	-7,95	-1,44	5,83	-7,86	-57,58	-10,46	0,50
20%	4,50	6,4	18,90	-42,75	-14,26	3,09	-46,61	-11,51	58,04	18,75	41,71	30,76	18,63	16,33	16,37	-4,36	-4,36	-1,89	-2,74	2,78	-1,34	5,22	13,28	-0,77	-51,77	-3,64	6,80
25%	5,63	7,0	25,64	-37,40	-8,22	9,11	-41,80	-6,09	65,53	24,86	48,62	37,47	24,80	22,51	22,48	1,44	1,44	3,96	3,11	8,42	4,29	10,89	19,67	5,30	-46,81	2,20	12,17
30%	6,75	7,6	31,59	-32,69	-2,89	14,42	-37,58	-1,33	72,14	30,23	54,69	43,41	30,23	27,95	27,87	6,54	6,54	9,11	8,25	13,36	9,24	15,87	25,30	10,64	-42,44	7,35	16,88
35%	7,88	8,2	36,95	-28,46	1,91	19,18	-33,80	2,91	78,09	35,05	60,12	48,76	35,09	32,83	32,69	11,11	11,11	13,72	12,86	17,78	13,66	20,33	30,35	15,44	-38,52	11,98	21,09
40%	9,00	8,8	41,84	-24,60	6,29	23,53	-30,36	6,76	83,53	39,43	65,05	53,66	39,52	37,28	37,08	15,26	15,26	17,92	17,04	21,80	17,69	24,37	34,96	19,81	-34,96	16,20	24,91
45%	10,13	9,4	46,36	-21,04	10,34	27,53	-27,20	10,29	88,54	43,47	69,58	58,19	43,60	41,38	41,13	19,08	19,08	21,77	20,89	25,49	21,38	28,09	39,20	23,83	-31,68	20,09	28,41
50%	11,25	10,0	50,57	-17,73	14,11	31,25	-24,27	13,56	93,21	47,22	73,78	62,42	47,38	45,19	44,88	22,62	22,62	25,35	24,47	28,91	24,81	31,53	43,14	27,57	-28,64	23,71	31,66
55%	12,38	10,6	54,51	-14,63	17,64	34,74	-21,54	16,61	97,58	50,72	77,70	66,39	50,92	48,75	48,39	25,93	25,93	28,70	27,80	32,10	28,01	34,75	46,82	31,06	-25,80	27,09	34,69
60%	13,50	11,2	58,23	-11,72	20,97	38,02	-18,96	19,47	101,70	54,02	81,38	70,13	54,25	52,10	51,69	29,04	29,04	31,84	30,94	35,10	31,02	37,77	50,29	34,35	-23,12	30,28	37,54
65%	14,63	11,8	61,76	-8,96	24,13	41,13	-16,53	22,17	105,61	57,14	84,86	73,68	57,40	55,27	54,81	31,98	31,98	34,81	33,90	37,93	33,86	40,62	53,57	37,47	-20,60	33,30	40,23
70%	15,75	12,4	65,12	-6,33	27,14	44,08	-14,23	24,72	109,32	60,10	88,16	77,07	60,39	58,29	57,77	34,76	34,76	37,63	36,72	40,61	36,55	43,33	56,69	40,42	-18,20	36,17	42,77
75%	16,88	13,0	68,32	-3,83	30,01	46,90	-12,03	27,15	112,87	62,92	91,30	80,31	63,23	61,16	60,59	37,42	37,42	40,32	39,39	43,16	39,11	45,90	59,67	43,24	-15,91	38,91	45,19
80%	18,00	13,6	71,39	-1,43	32,75	49,59	-9,94	29,47	116,27	65,62	94,29	83,41	65,96	63,91	63,29	39,95	39,95	42,89	41,95	45,60	41,56	48,36	62,51	45,94	-13,72	41,53	47,50
85%	19,13	14,2	74,34	0,87	35,39	52,18	-7,93	31,68	119,53	68,20	97,16	86,40	68,57	66,55	65,88	42,38	42,38	45,34	44,40	47,93	43,90	50,71	65,24	48,53	-11,63	44,05	49,71
90%	20,25	14,8	77,18	3,08	37,94	54,66	-6,00	33,81	122,67	70,69	99,92	89,27	71,07	69,08	68,36	44,72	44,72	47,71	46,76	50,17	46,15	52,97	67,86	51,01	-9,62	46,47	51,84
95%	21,38	15,4	79,92	5,21	40,39	57,06	-4,14	35,86	125,70	73,08	102,57	92,05	73,49	71,52	70,76	46,96	46,96	49,98	49,02	52,33	48,32	55,14	70,39	53,41	-7,68	48,80	53,88
100%	22,50	16,0	82,57	7,27	42,76	59,38	-2,35	37,83	128,63	75,40	105,13	94,74	75,82	73,88	73,07	49,13	49,13	52,18	51,21	54,41	50,41	57,24	72,83	55,72	-5,81	51,05	55,84

Example with refrigerant medium R507

Settings:

- Set value = 60 % $\hat{=}$ 13.5 bar
- Pband = 10 %
- n-min = 0 %
- n-max = 100 %

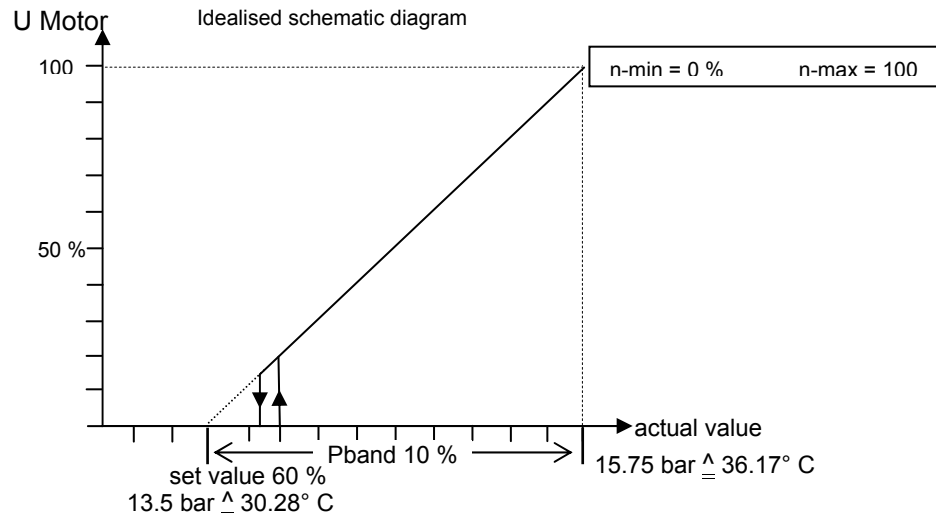

7.2.6 Setting with pressure / temperature refrigerant medium table for type PKDM5..80 with MBG-30I.

i Calculation for relative pressure (differential measurement of pressure relative to ambient pressure)

Set Positi	MBG-30I [bar]	Signal [mA]	R12 [°C]	R13 [°C]	R13b1 [°C]	R22 [°C]	R23 [°C]	R32 [°C]	R114 [°C]	R134a [°C]	R142B [°C]	R227 [°C]	R401 [°C]	R401A [°C]	R401B [°C]	R402 [°C]	R402A [°C]	R402B [°C]	R404A [°C]	R407A [°C]	R407B [°C]	R407C [°C]	R500 [°C]	R502 [°C]	R503 [°C]	R507 [°C]	R717 [°C]
0%	0,00	4,0	-30,09	-81,99	-58,14	-41,11	-82,44	-52,53	3,45	-26,43	-10,07	-17,58	-27,05	-29,21	-28,97	-47,59	-47,59	-45,46	-46,36	-39,47	-43,49	-37,31	-33,80	-45,54	-88,64	-46,51	-33,59
5%	1,50	4,8	-6,28	-62,83	-36,81	-19,52	-64,82	-32,24	30,02	-4,29	15,44	5,82	-4,65	-6,93	-6,74	-26,34	-26,34	-24,06	-24,92	-18,64	-22,74	-16,35	-10,77	-23,63	-70,55	-25,59	-13,65
10%	3,00	5,6	8,11	-51,33	-23,92	-6,57	-54,36	-20,30	46,05	8,93	30,54	20,05	8,71	6,40	6,52	-13,71	-13,71	-11,33	-12,18	-6,32	-10,44	-3,95	3,02	-10,53	-59,77	-13,02	-1,88
15%	4,50	6,4	18,90	-42,75	-14,26	3,09	-46,61	-11,51	58,04	18,75	41,71	30,76	18,63	16,33	16,37	-4,36	-4,36	-1,89	-2,74	2,78	-1,34	5,22	13,28	-0,77	-51,77	-3,64	6,80
20%	6,00	7,2	27,70	-35,77	-6,38	10,95	-40,34	-4,44	67,82	26,72	50,72	39,52	26,68	24,39	24,35	3,21	3,21	5,75	4,89	10,13	6,01	12,62	21,62	7,15	-45,29	3,98	13,80
25%	7,50	8,0	35,22	-29,82	0,36	17,65	-35,02	1,54	76,17	33,49	58,37	47,03	33,52	31,26	31,14	9,64	9,64	12,23	11,37	16,36	12,24	18,89	28,72	13,89	-39,79	10,49	19,73
30%	9,00	8,8	41,84	-24,60	6,29	23,53	-30,36	6,76	83,53	39,43	65,05	53,66	39,52	37,28	37,08	15,26	15,26	17,92	17,04	21,80	17,69	24,37	34,96	19,81	-34,96	16,20	24,91
35%	10,50	9,6	47,80	-19,91	11,63	28,80	-26,20	11,41	90,13	44,75	71,01	59,63	44,89	42,68	42,41	20,29	20,29	22,99	22,11	26,66	22,55	29,27	40,54	25,10	-30,65	21,32	29,52
40%	12,00	10,4	53,23	-15,65	16,49	33,60	-22,43	15,62	96,15	49,58	76,42	65,09	49,77	47,59	47,24	24,85	24,85	27,61	26,72	31,06	26,97	33,70	45,62	29,92	-26,73	25,99	33,71
45%	13,50	11,2	58,23	-11,72	20,97	38,02	-18,96	19,47	101,70	54,02	81,38	70,13	54,25	52,10	51,69	29,04	29,04	31,84	30,94	35,10	31,02	37,77	50,29	34,35	-23,12	30,28	37,54
50%	15,00	12,0	62,90	-8,07	25,15	42,13	-15,75	23,03	106,87	58,14	85,98	74,83	58,41	56,29	55,81	32,92	32,92	35,77	34,86	38,84	34,77	41,54	54,63	38,47	-19,78	34,28	41,09
55%	16,50	12,8	67,27	-4,65	29,06	45,97	-12,75	26,35	111,71	61,99	90,27	79,24	62,30	60,22	59,67	36,55	36,55	39,44	38,52	42,33	38,27	45,06	58,69	42,32	-16,66	38,01	44,40
60%	18,00	13,6	71,39	-1,43	32,75	49,59	-9,94	29,47	116,27	65,62	94,29	83,41	65,96	63,91	63,29	39,95	39,95	42,89	41,95	45,60	41,56	48,36	62,51	45,94	-13,72	41,53	47,50
65%	19,50	14,4	75,30	1,61	36,25	53,02	-7,27	32,40	120,59	69,04	98,09	87,37	69,41	67,40	66,72	43,17	43,17	46,14	45,20	48,69	44,66	51,47	66,13	49,37	-10,95	44,86	50,43
70%	21,00	15,2	79,01	4,51	39,58	56,27	-4,75	35,18	124,71	72,30	101,70	91,13	72,70	70,72	69,97	46,23	46,23	49,23	48,28	51,62	47,61	54,43	69,56	52,62	-8,32	48,03	53,21
75%	22,50	16,0	82,57	7,27	42,76	59,38	-2,35	37,83	128,63	75,40	105,13	94,74	75,82	73,88	73,07	49,13	49,13	52,18	51,21	54,41	50,41	57,24	72,83	55,72	-5,81	51,05	55,84
80%	24,00	16,8	85,97	9,91	45,81	62,35	-0,05	40,35	132,40	78,36	108,40	98,20	78,81	76,91	76,03	51,91	51,91	54,99	54,01	57,07	53,09	59,92	75,97	58,69	-3,41	53,94	58,36
85%	25,50	17,6	89,24	12,45	48,74	65,20	2,15	42,76	136,01	81,20	111,54	101,52	81,68	79,81	78,87	54,57	54,57	57,69	56,70	59,62	55,65	62,49	78,97	61,54	-1,11	56,72	60,78
90%	27,00	18,4	92,39	14,89	51,56	67,95	4,26	45,07	139,49	83,93	114,55	104,73	84,44	82,60	81,60	57,13	57,13	60,28	59,28	62,06	58,11	64,96	81,86	64,28	1,10	59,39	63,09
95%	28,50	19,2	95,43	17,25	54,28	70,59	6,30	47,30	142,85	86,57	117,44	107,83	87,09	85,29	84,23	59,59	59,59	62,77	61,76	64,42	60,48	67,34	84,65	66,91	3,22	61,97	65,32
100%	30,00	20,0	98,37	19,52	56,92	73,15	8,26	49,44	146,10	89,11	120,24	110,83	89,66	87,89	86,77	61,97	61,97	65,18	64,16	66,69	62,76	69,63	87,34	69,46	5,28	64,46	67,46

Example with refrigerant medium R507

Settings:

- Set value = 50 % $\hat{=}$ 15.0 bar
- Pband = 10 %
- n-min = 0 %
- n-max = 100 %

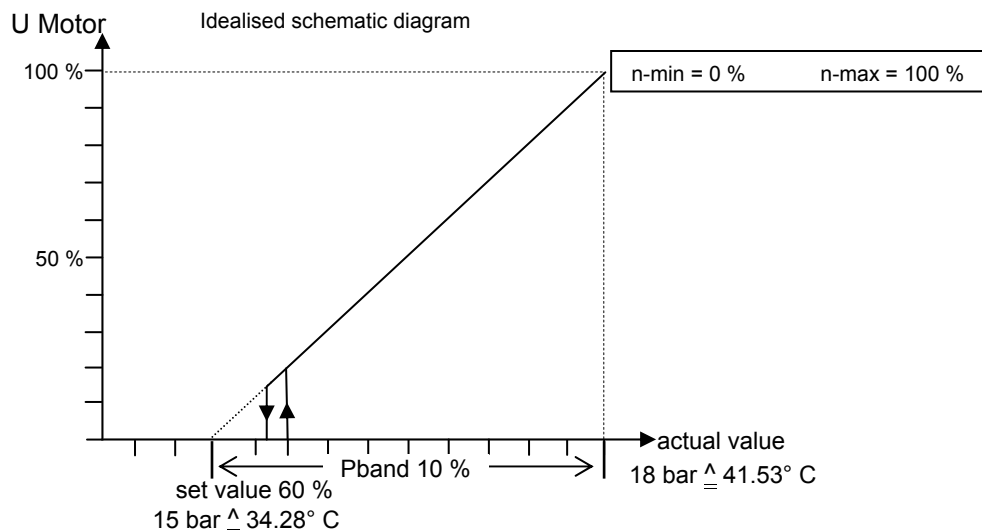

7.2.7 Minimum airflow rate (Minimum air shutdown active / not active)

The minimum airflow rate can be switched "ON" or "OFF" using dipswitch.

Dipswitch S1-2 **OFF**: Shutdown **active** = Without minimum airflow rate

Dipswitch S1-2 **ON**: Shutdown **not active** = With minimum airflow rate (factory setting)

When the setpoint is reached, the modulation is reduced to "0" %, or to the set value if "Min. Speed" is specified.

- ◆ If minimum air shutdown is **active**, when actual value = setpoint, "n-min" is disconnected to "0".
- ◆ When minimum air shutdown is **inactive** (factory setting) there is no disconnection, i.e. minimum ventilation is always assured (fan does not go below "n-min").

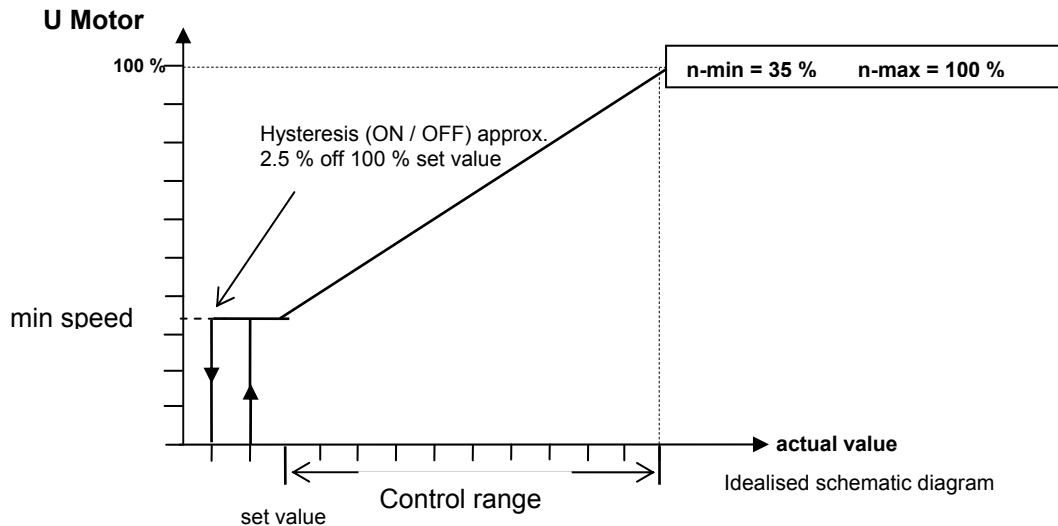

7.2.8 Reversed control function (Act>Set = n+)

There are **TWO** functions for the control's action, switchover to the heating function is possible by means of the internal dipswitch, **the controller setting made at the factory is for the cooling function.**

1. S1-1 **OFF** \wedge increasing output voltage for increasing actual value (cooling)
2. S1-1 **ON** $\u2264$ increasing output voltage for decreasing actual value (heating)

Only for PKDM

Alternatively the change-over of the control function can be made by a contact at digital input D2 "Digital IN 2"! When terminals "D2"- "D2" are bridged, the device works with the opposite function than the set with dipswitch 1 (6 general settings).

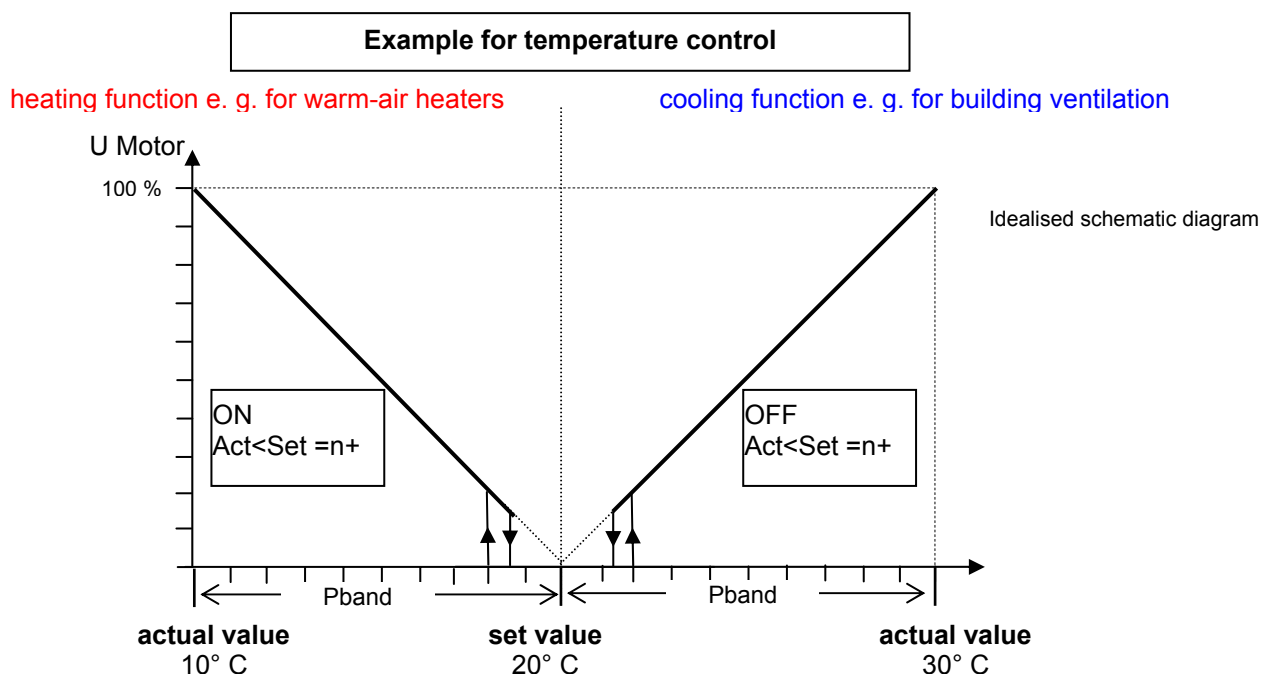

8. Faults and rectification of these

8.1 Mains fault

i **Function only for a connected inductive load**

The device is provided with a built-in phase-monitoring function for the mains supply. In the event of a mains interruption (failure of a fuse or mains phase) the unit switches off after a delay. The unit then switches on again automatically when the voltage has been restored.

Line fault (failure of a line phase)	yellow + red
--------------------------------------	--------------

Remedy:
Check the mains supply and the internal semiconductor fuses.

For **PKDT5 “mobile application“** version, phase failure is deactivated!
In special cases phase failure can be deactivated for other types
(☞ Electrical connections: Adjustment to specific mains conditions)

8.2 Temperature fault

The unit is fitted with a built-in temperature monitoring device coupled to the internal heat sink. The unit cuts out at a temperature of approximately 90 °C and cuts in automatically again when the unit has cooled down again to about 65 °C. An excessively high unit temperature is signalled by the internal LED's.

Excessively high unit temperature (measured at the internal heat sink)	red blinking
--	--------------

Interruption in the leads to the heat-sink sensor	green + red on and yellow blinking
---	------------------------------------

Remedy in the event of an excessively high unit temperature:
- Check whether the heat dissipation is adequate.
- Check for any overloading of the unit, i.e. whether the maximum control current occurring is above the rated current for the unit.

8.3 Motor fault

The unit cuts out and does not switch on again when the connected thermal contacts or PTC resistors for type PKDM have tripped (interruption between both terminals “TK” (☞ Electrical connection: Motor protection)).

Motor fault (interruption TK terminals)	red
---	-----

8.4 Sensor-signal faults

Function only for operation as a P-controller

The unit is fitted with a built-in monitoring device for the sensor signal. A fault is signalled over the internal LEDs in the event of an interruption or a short circuit in the sensor conductors, or measured values that are outside of the measuring range for the unit.

For controllers model range PKDM sensor monitoring is also for the second input "E2" (if activated by dipswitch).

Interruption / short circuit in the sensor leads or sensor values measured that are outside of the measuring range	yellow + green
--	----------------

Cause for the signal "Sensor fault" and the response by the controller

1. For a temperature-dependent control (input for temperature sensor, type TF..):

- In the event of an interruption in the sensor leads.
The controller acts as in the case of an extremely high temperature, i.e. maximum output voltage.
(Control response for increasing speed for increasing actual value, see setting for operation reversed control function (actual>set = n+)).
- In the event of a short circuit in the sensor leads.
The controller acts as in the case of a very low temperature, i.e. minimum output voltage.
(Control response for increasing speed for increasing actual value, see setting for operation reversed control function (actual>set = n+)).
- In the case of temperatures at the sensor that are outside the measuring range of the controller,
 - PKDT5: at approx. 0° C and as of approx. +80° C.
 - PKDM5/10/12/15/25/35...: at approx. -25° C and as of approx. +75° C.

The controller functions automatically again with the value measured at the temperature sensor after the fault has been rectified or when the actual temperature returns to within the measuring range of the controller.

2. For a pressure-dependent control (input 0-10 V / 4-20 mA):

- In the event of an interruption in the sensor leads or for a short circuit between the terminals "E" and "GND".
The controller acts as in the case of a very small measured value, i.e. minimum output voltage.
(Control response for increasing speed for increasing actual value, see setting for operation reversed control function (actual>set = n+)).
- When the upper or lower limit of the measuring range for the sensor has been reached
 - For a 4-20 mA input for a sensor signal of approx. 4 mA or approx. 20 mA
 - For a 0-10 V input for a sensor signal of approx. 0 V or approx. 10 V

The controller functions automatically again with the value measured at the temperature sensor after the fault has been rectified.

8.5 If controller doesn't work correctly

Setting of dipswitch not under voltage!

If the device is on mains supply modifications will not be identified and realized.



It is forbidden to carry out work on electrically live parts. The enclosure rating of the device when open is IP00! It is possible to inadvertently touch components carrying hazardous voltages.

9. Enclosure

9.1 Connection diagram PKDT5

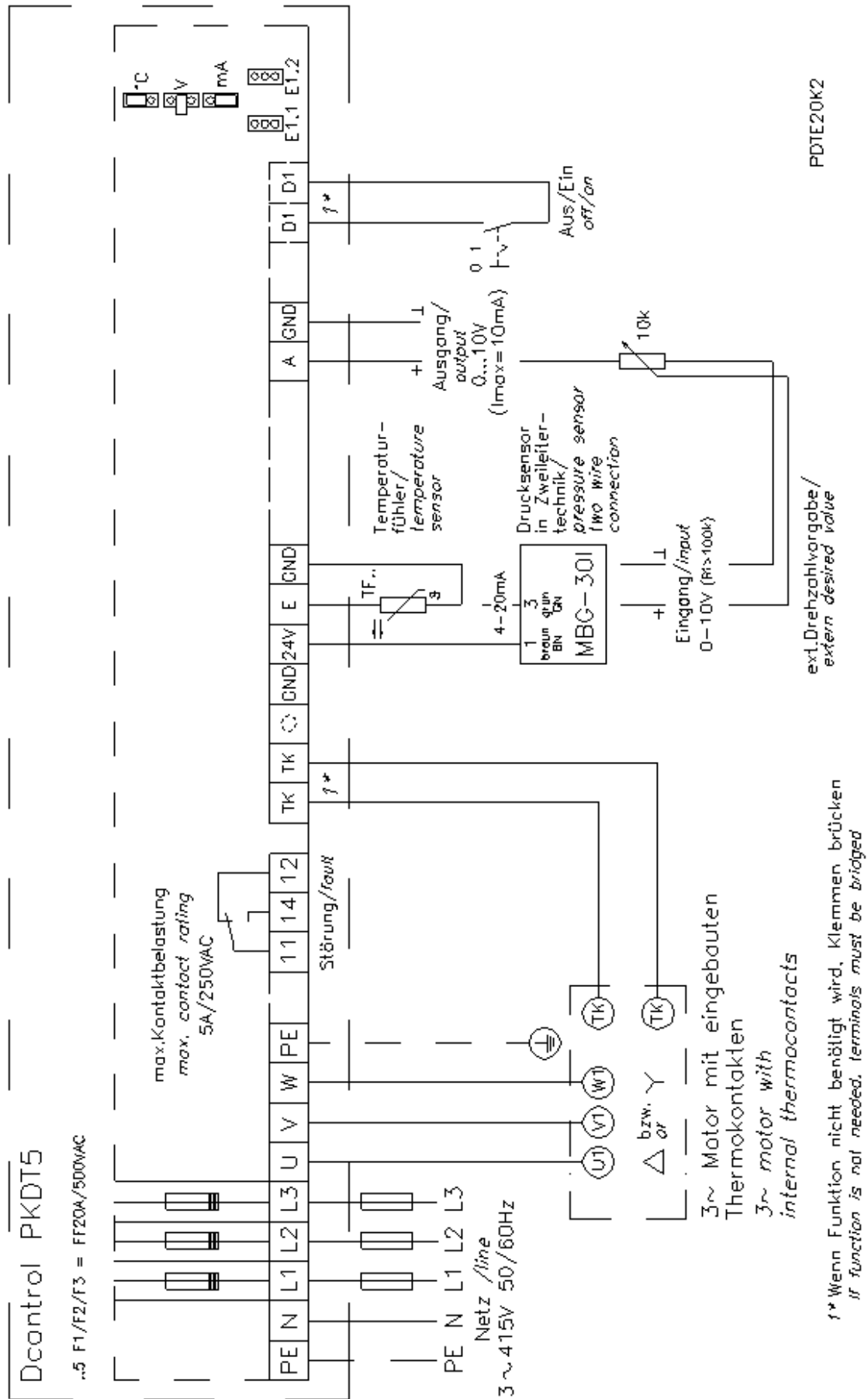

PDTE20K2

9.2 Connection diagram PKDM5..80

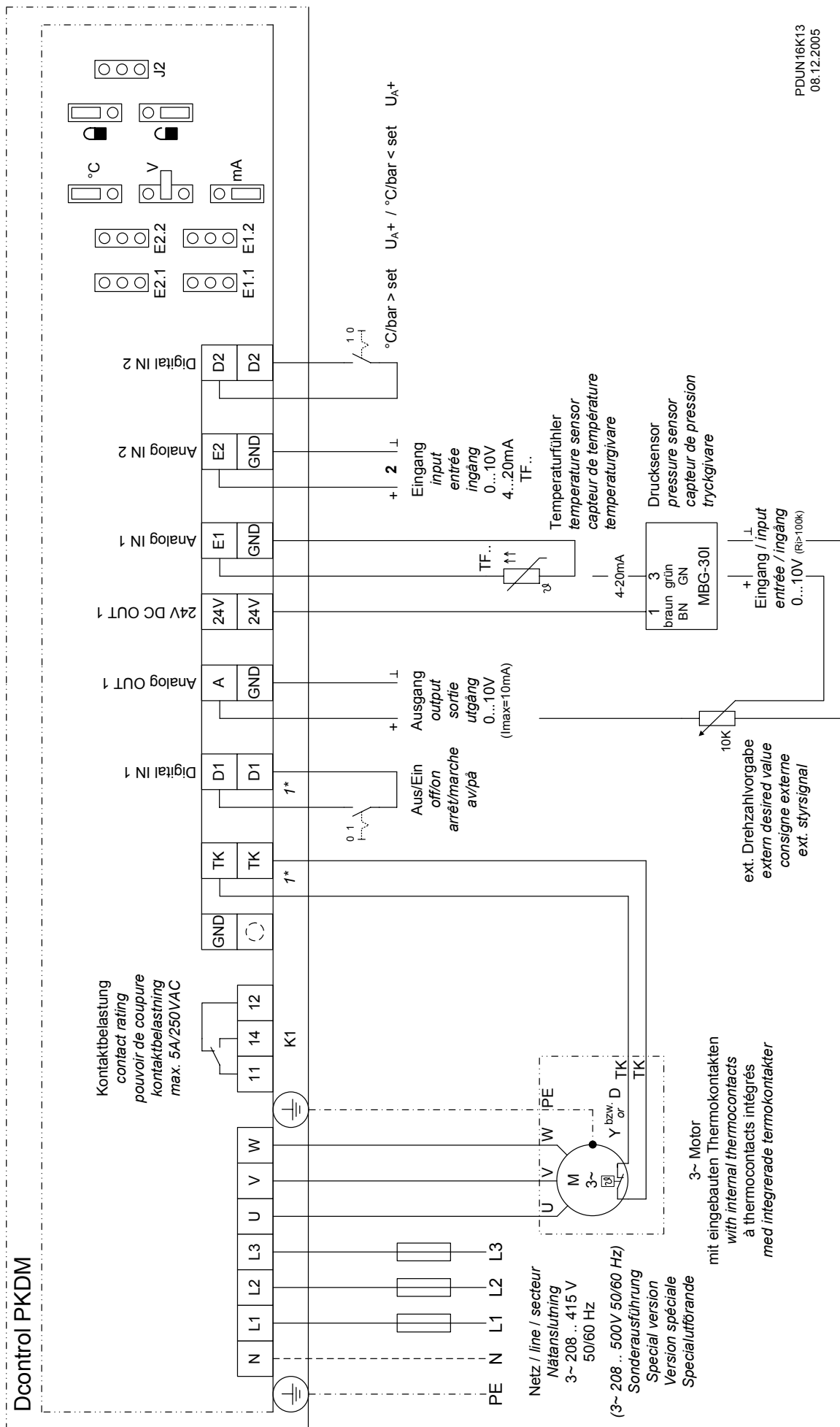

PDUN16K13
 08.12.2005

1* Si la fonction n'est pas utile, les bornes doivent être reliées
 Om funktionen inte används, måste plintarna byglas

1* Wenn Funktion nicht benötigt wird, Klemmen brücken
 If function is not needed, terminals must be bridged

9.3 Connection suggestion for several motors with motor protection unit type STDT

- Total motor protection: Automatic cut-off by thermocontact actuation Δ motor overtemperature. Button for Reset after malfunction.
- Line protection: A thermal over current sensor and a magnetic short circuit releasing elements are the parts of the integral line protection.
- No cut-off if the mains supply is interrupted.
-

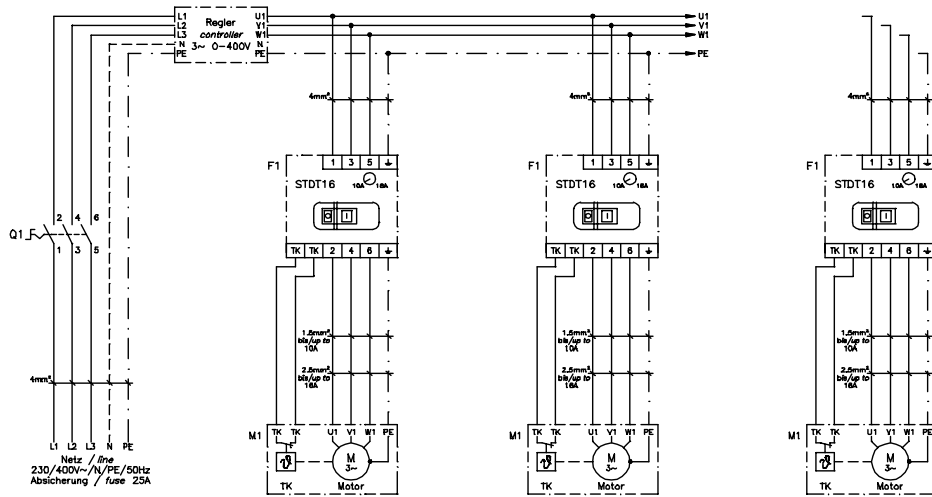

KT00005H

9.4 Dimension sheet

IP 54 model range: PKDT5, PKDM5/10 (PKDM12/15)

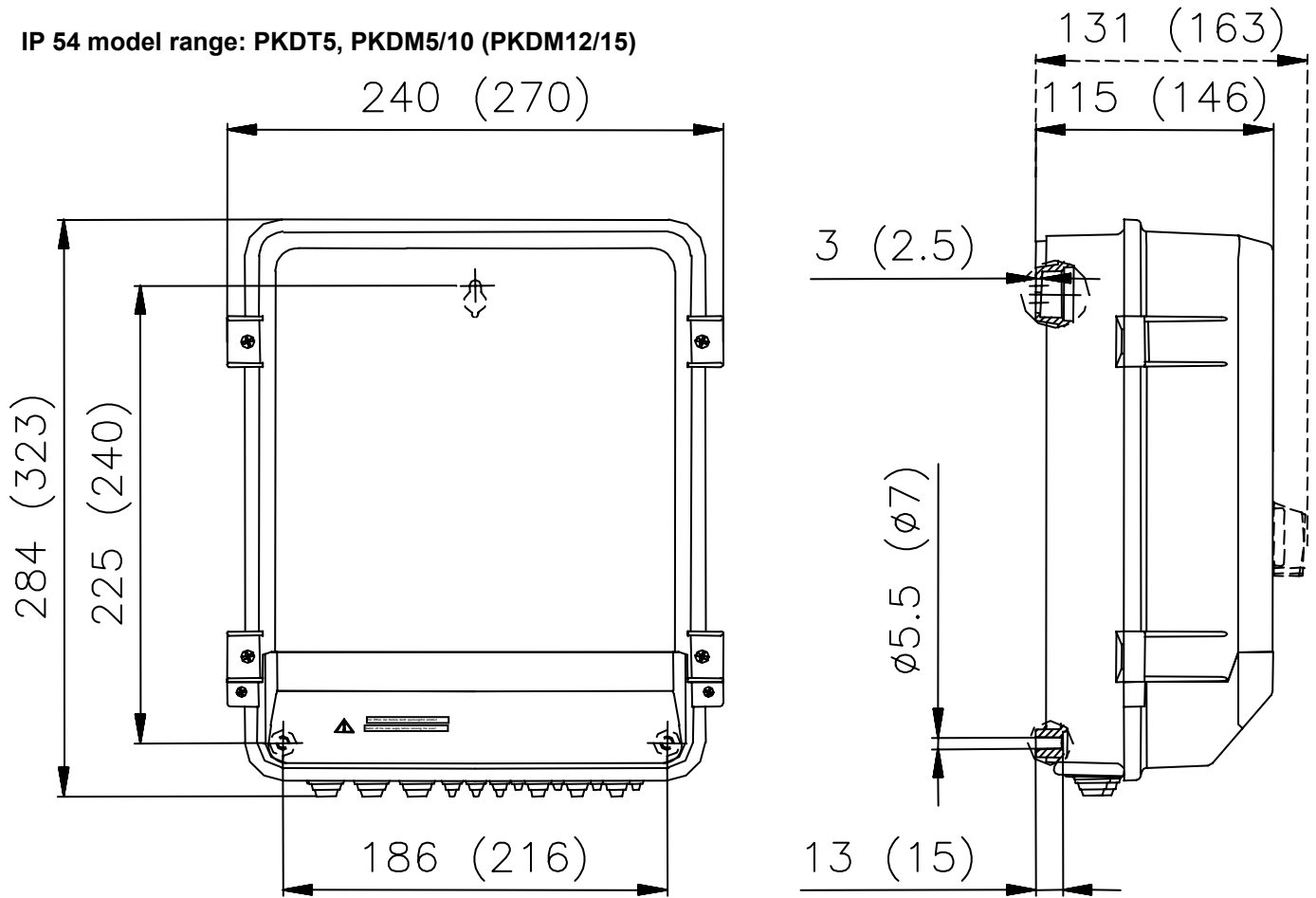

IP 54 model range: PKDM20

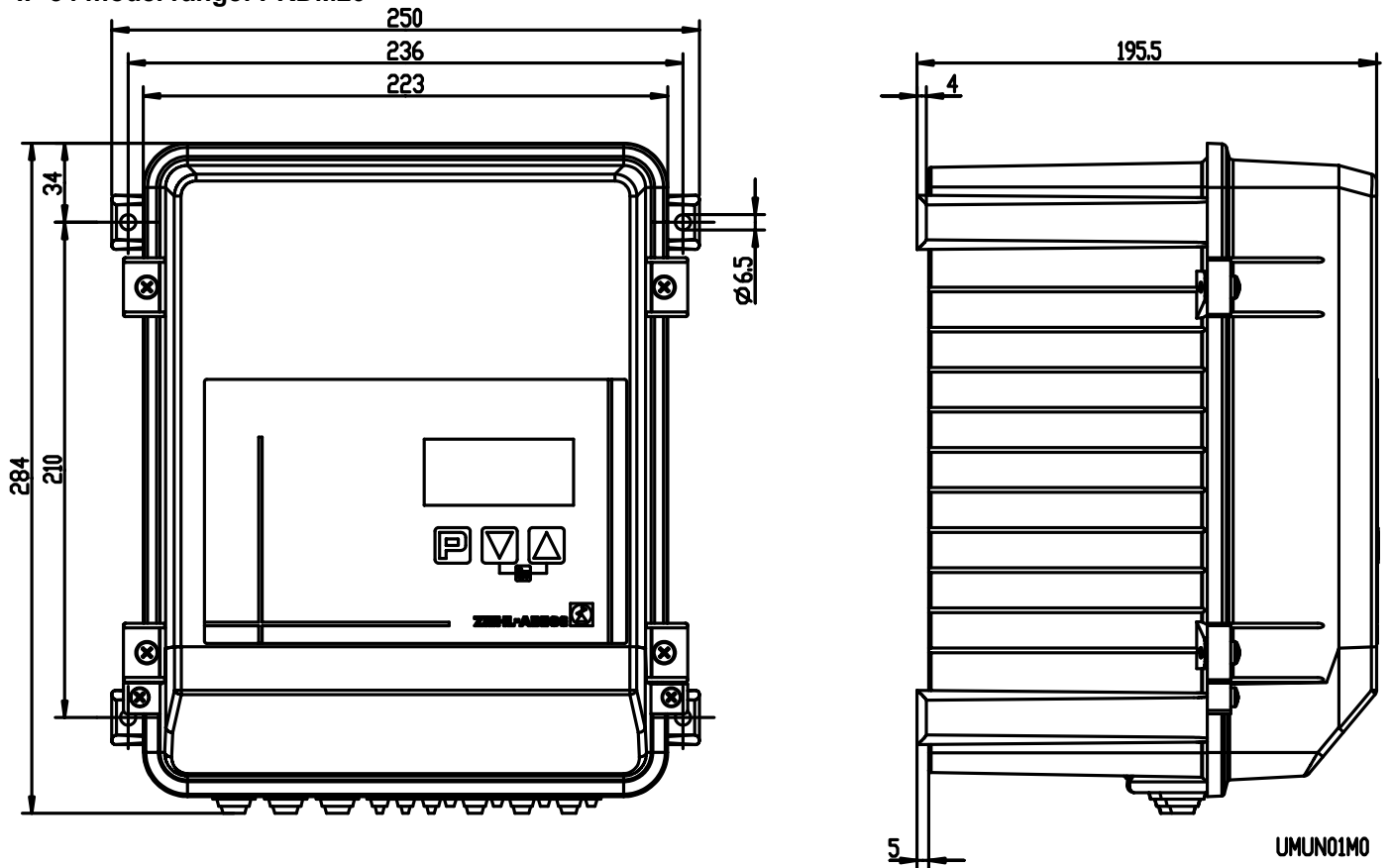

IP 54 model range: PKDM25/35 (PKDM50/80)

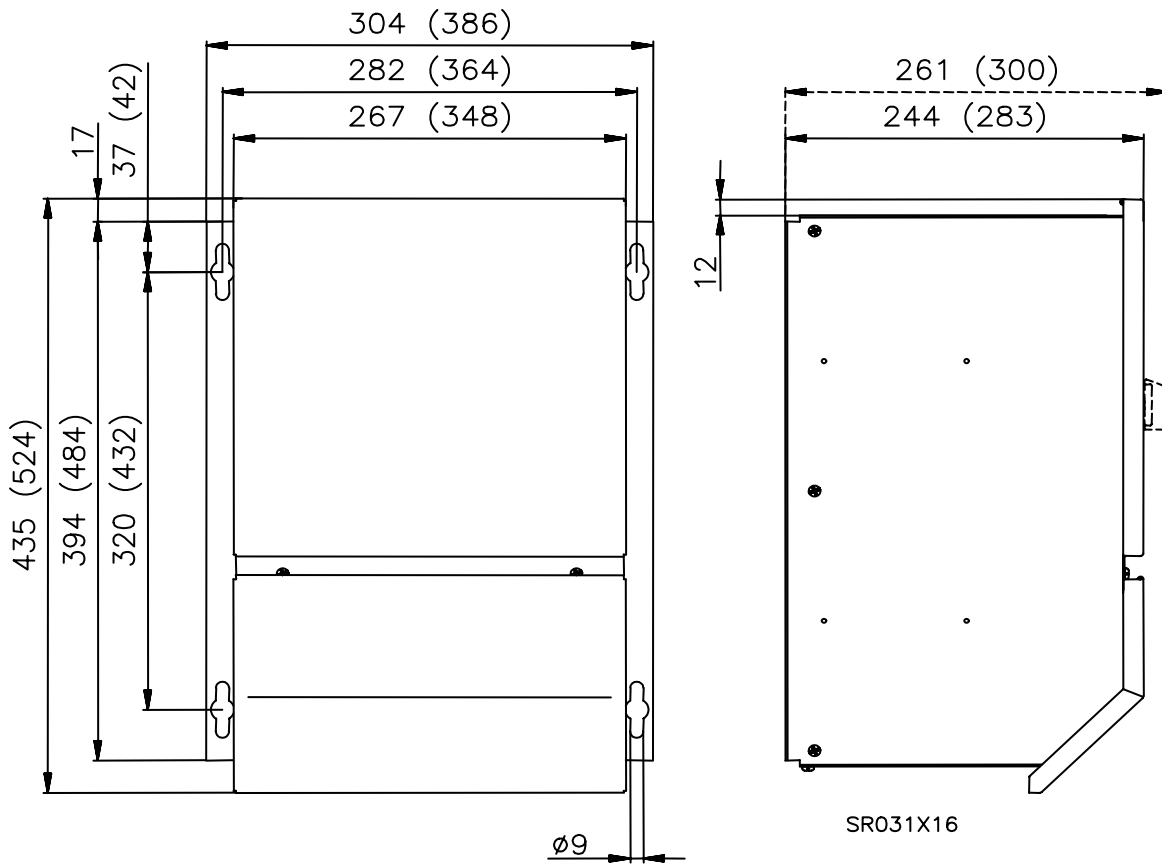

IP 20 model range: PKDM25/35E (PKDM50/80E)

