

SAVE VSR 200/B

Installation instructions

GB

Document in original language | 398651 · v01



© Copyright Systemair UAB

All rights reserved

E&OE

Systemair UAB reserves the rights to alter their products without notice.

This also applies to products already ordered, as long as it does not affect the previously agreed specifications.

Systemair is not liable or bound by warranty if these instructions are not adhered to during installation or service.

Contents

1	Overview	1
1.1	General Description	1
1.2	Warranty	1
1.3	Type label	1
2	Important Safety Information	1
2.1	Intended Use	1
2.2	Admonitions	2
3	Technical Data	2
3.1	Dimensions and Weight	3
3.2	Duct connections	4
3.3	Installation recommendation regarding condensation	4
3.3.1	Condensation inside of the unit	4
3.3.2	Condensation outside of the unit	4
4	Delivery, Transport, Storage	5
4.1	Transport and storage	5
4.2	Delivery/Unloading	5
5	Prerequisites for Installation	6
5.1	Location and Space Requirements	7
5.2	Wall preparation for mounting bracket	7
5.3	Outdoor Air Intake Location Recommendation	7
5.4	Access to Power supply	7
6	Installation	7
6.1	Ventilation Duct Connection and Insulation	8
6.2	Installation and Configuration of Accessories	9
7	Electrical connections	9
7.1	Main circuit board layout	9
7.2	External connections (Connection board)	10
8	Before Starting the System	10
9	Commissioning	11
10	Concluding Routines	12
11	Disposal and recycling	12
12	EU Declaration of Conformity	13

1 Overview

1.1 General Description

Read the instructions carefully and in its entirety.

For description of advanced settings and installation of accessories see **Service and Accessories Installation manual**.

All documents can be found in our online catalogue at www.systemair.com.

1.2 Warranty

For the assertion of warranty claims, the products must be correctly connected and operated, and used in accordance with the data sheets. Further prerequisites are a completed maintenance plan with no gaps and a commissioning report. Systemair will require these in the case of a warranty claim.

1.3 Type label

Before calling your service representative, make a note of the specification and production number from the type label, which can be found next to the external connections and inside of the unit.

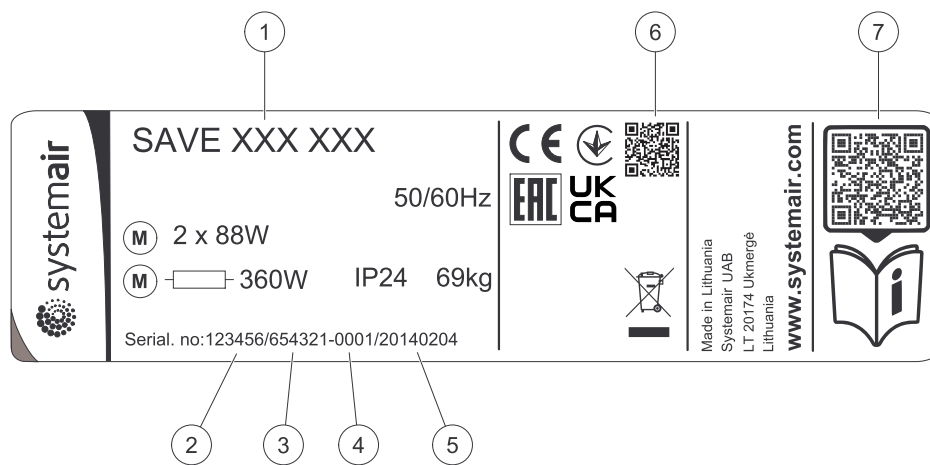

Fig. 1 Type label

Position	Description
1	Product code (product specification)
2	Product item number
3	Production order number
4	Serial number
5	Production date (YY.MM.DD)
6	Scannable code for manufacturing order (MO) number and software version
7	Scannable code for the spare parts list and documentation

2 Important Safety Information

- Observe and respect local conditions, regulations and laws.
- Safety elements may not be dismantled, circumvented or deactivated.
- Wear protective equipment during all work in the vicinity of the unit.
- Do not allow children to play with the device.

2.1 Intended Use

- Abide by the system-related conditions and requirements of the system manufacturer or plant constructor.
- Keep all the warning signs on the device and in a legible condition.
- The device is not to be used by persons (including children) with reduced physical, sensory or mental capabilities, or lack of experience and knowledge, unless they have been given supervision or instruction.

- The system should operate continuously, and only be stopped for maintenance/service.
- Do not connect tumble dryers to the ventilation system.
- Make sure that filters are mounted before starting the unit.

2.2 Admonitions



Danger

- Make sure that the mains supply to the unit is disconnected before performing any maintenance or electrical work!
- All electrical connections and maintenance work must be carried out by an authorized installer and in accordance with local rules and regulations.



Warning

- This product is not intended to be used by children or people with reduced physical or mental ability or lack of experience and knowledge, if no instruction concerning the use has been given by the person responsible for their safety or that this person is supervising the operation. Children should be supervised so that they can not play with the product.
- Beware of sharp edges during mounting and maintenance. Use protective gloves.



Warning

- Risk of injury due to rotating parts that have not come to a complete standstill after mains supply to the unit have been disconnected.

3 Technical Data

Re-heater	1000 W
Fans	162 W
Total power consumption	1162 W
Fuse	10 A

Voltage 230V 1~, 50Hz

3.1 Dimensions and Weight

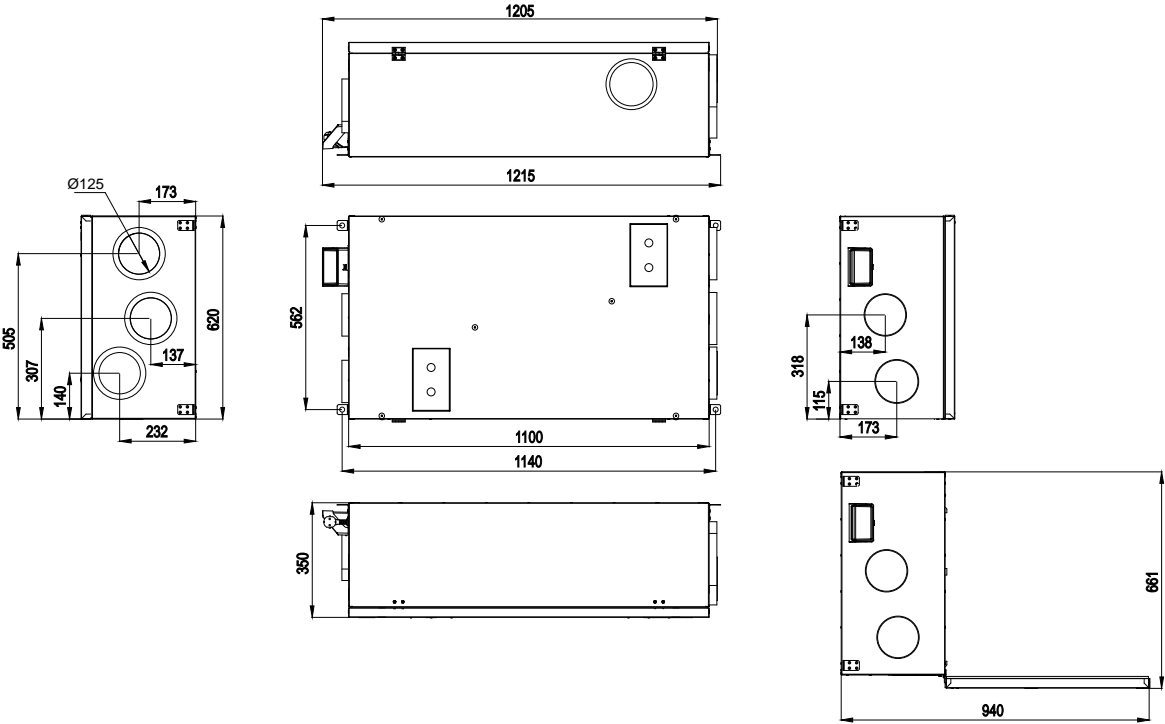

Fig. 2 Dimensions of left hand unit

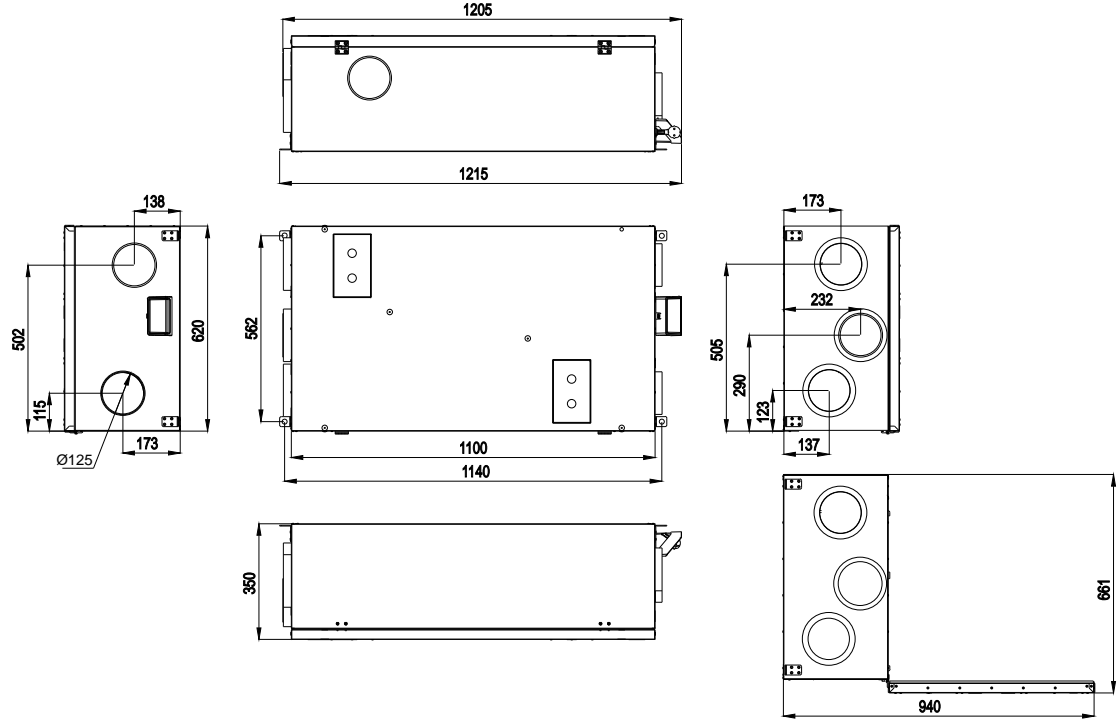
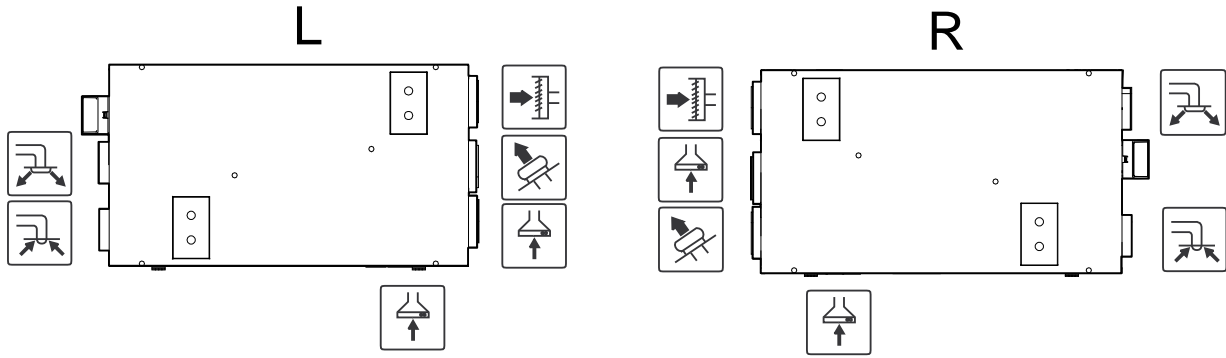

Fig. 3 Dimensions of right hand unit

The unit weight is 56 kg.

3.2 Duct connections



Symbol	Description	Symbol	Description	Symbol	Description
	Supply air		Outdoor air		Cooker hood air
	Exhaust air		Extract air		

3.3 Installation recommendation regarding condensation

3.3.1 Condensation inside of the unit

When the unit is installed in a cold attic (close to outdoor temperature) the unit should run continuously. If the unit is intended to be stopped by the user manually or due to calendar function we recommend to install air tight dampers at extract and supply air ducts. The dampers will ensure that no air circulates from the warm parts of the building through the unit to outside (chimney effect). If no dampers are installed there is risk of condensation inside the unit and the outdoor ducts during these stop periods. It also might be that cold air from outside could pass the unit and enter into the building. That could cause condensation outside the supply and extract air ducts and even at the valves in the rooms.

When the unit is not running due to late commissioning in winter time, the supply and extract air ducts should be disconnected and closed due to above mentioned effects until commissioning and regular operation.

3.3.2 Condensation outside of the unit

When the unit is installed in warm humid areas (like laundry) together with low outdoor temperature there is a certain point where moisture can condense outside of the casing. The condensation relation to indoor relative humidity, room and outdoor temperature is shown diagram below. The condensation outside of the unit do not occur in zones below each curve.

Important

Recommendation: If condensation occurs, increase ventilation in area close to the unit.

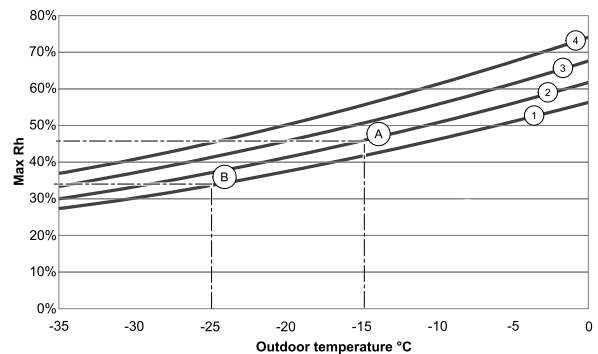

Examples when condensation outside of the unit can occur:

Example A: If the unit is installed in room where temperature is 22°C, outside temperature is -15°C, then dew will start accumulating when relative humidity is 46% and higher.

Example B: If the unit is installed in room where temperature is 20°C, outside temperature is -25°C, then dew will start accumulating when relative humidity is 34% and higher.

- 1. Room temperature 20°C
- 2. Room temperature 22°C
- 3. Room temperature 24°C
- 4. Room temperature 26°C

4 Delivery, Transport, Storage

4.1 Transport and storage

The SAVE VSR 200/B should be stored and transported in such a way that it is protected against physical damage. It should be covered so dust, rain and snow cannot enter and damage the unit and its components.

Important

- Use the packaging exclusively as transport protection and not as a lifting aid.
- Load and unload the air handling unit carefully.

4.2 Delivery/Unloading

The appliance is delivered in one piece containing all necessary components, wrapped in plastic on a pallet for easy transportation.

Checking delivery

- Check the packaging and the air handling unit for transport damage. Any findings should be noted on the cargo manifest.
- Check completeness of the delivery.

Verify that all ordered equipment is delivered before starting the installation. Any discrepancies from the ordered equipment must be reported to the supplier of Systemair products.



Warning

When opening the transport packaging, there is a risk of damage from sharp edges, nails, staples, splinters etc.

Unpacking

- Check the air handling unit for visible transport damage.
- Only remove the packaging shortly before assembly.
- Beware of sharp edges during mounting and maintenance. Use protective gloves.

5 Prerequisites for Installation

To ensure a proper and fail-free operation, it is important that the unit is installed according to these instructions.

The unit can be installed in the following positions.

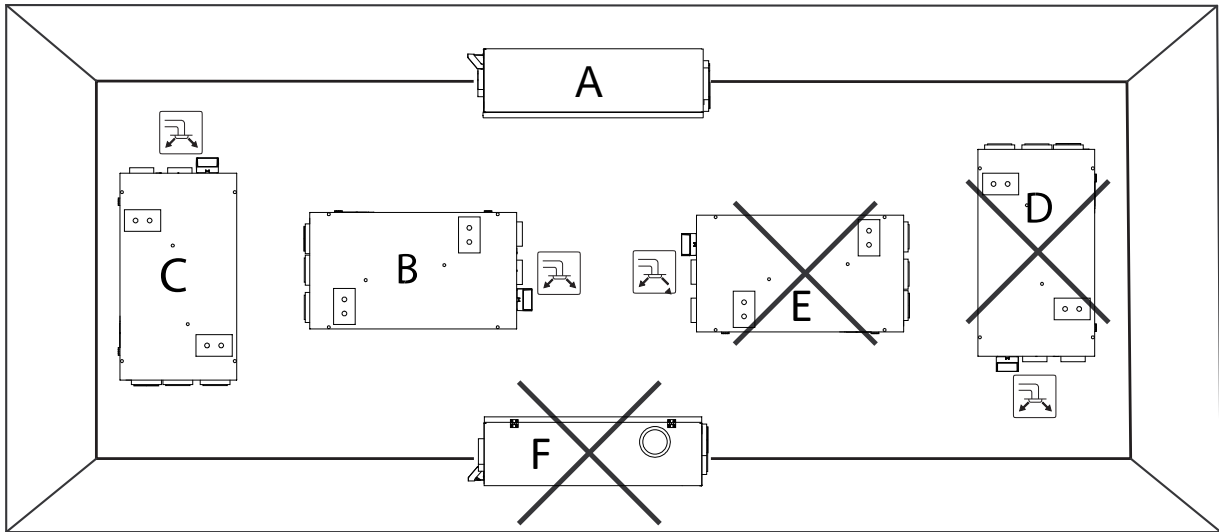

Fig. 4 SAVE VSR 200/B L

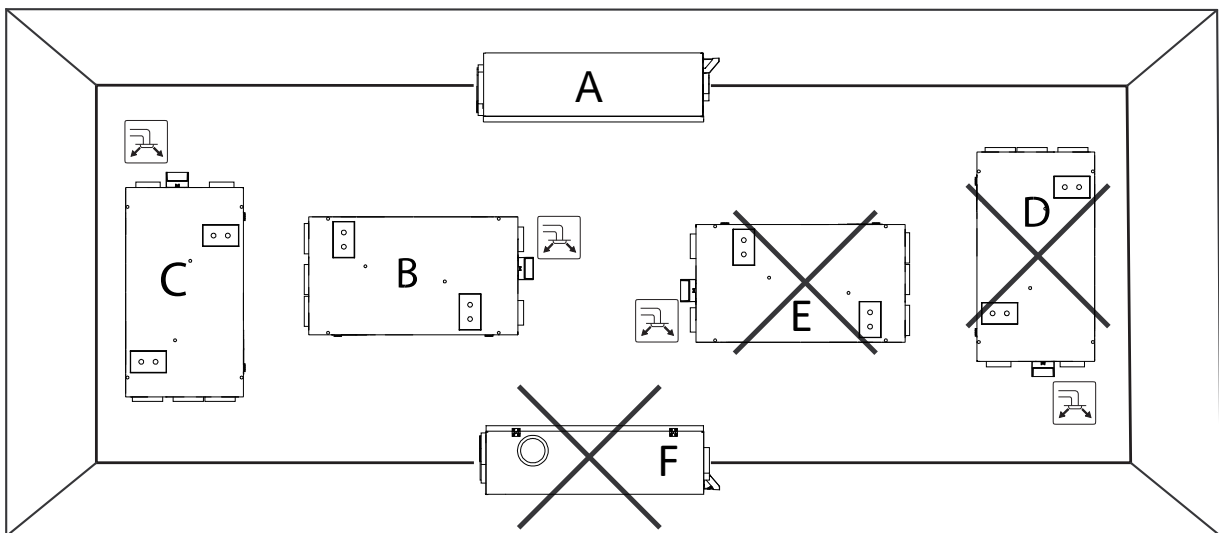



Fig. 5 SAVE VSR 200/B R

A. Ceiling installation. Left and right connections are possible.



B. Horizontal wall installation with the supply air  upwards is allowed.
A wall mounting kit is required. Not delivered with the unit.



C. Vertical wall installation with the supply air  upwards is allowed.
A wall mounting kit is required. Not delivered with the unit.



D. Vertical wall installation position D with the supply air  downwards is **not allowed** due to the fact that the heat from the re-heater is rising in the unit.

E. Upside down installation is **NOT** allowed.

F. Installation on the floor is not allowed.

5.1 Location and Space Requirements

The SAVE VSR 200/B should preferably be installed in a separate room (e.g. storeroom, laundry room or similar).



Note:

SAVE VSR 200/B must be installed in a heated area.

When choosing the location it should be kept in mind that the unit requires maintenance regularly and that the inspection door should be easily accessible. Leave free space for opening the door and for taking out the main components.

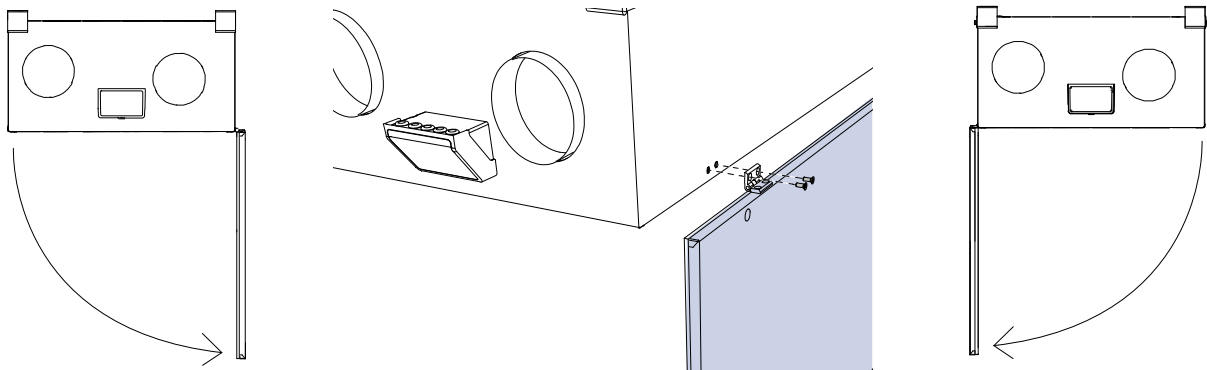
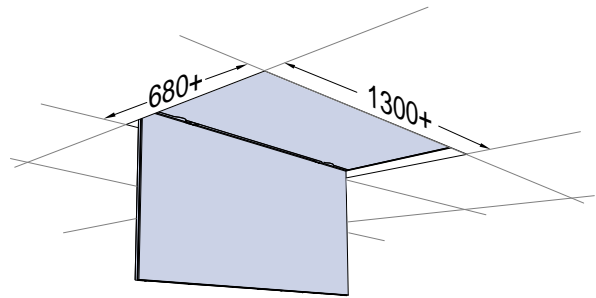

5.2 Wall preparation for mounting bracket

The unit should be installed in such a way that there is no vibration noise coming from the wall on which the unit is installed.

5.3 Outdoor Air Intake Location Recommendation

Recommended installation location for the outdoor air intake is the northern or eastern side of the building and with a distance to openings for discharge of stale ventilation air, kitchen ventilator, central vacuum system, waste water drainage and other pollution sources like exhaust from traffic, etc. Exhaust air should ideally be led via a roof cowl to the outside and with a good distance from the outdoor air intake, windows, etc.

5.4 Access to Power supply

The SAVE VSR 200/B is supplied with approximately 1 – 1,5 m cable and plug for 230V, single phase earthed connection.

Make sure a power outlet is reachable by the plug.

6 Installation

Important

- The device may only be installed by qualified, instructed and trained personnel. The persons must know the relevant safety directives in order to recognise and to avoid risks.

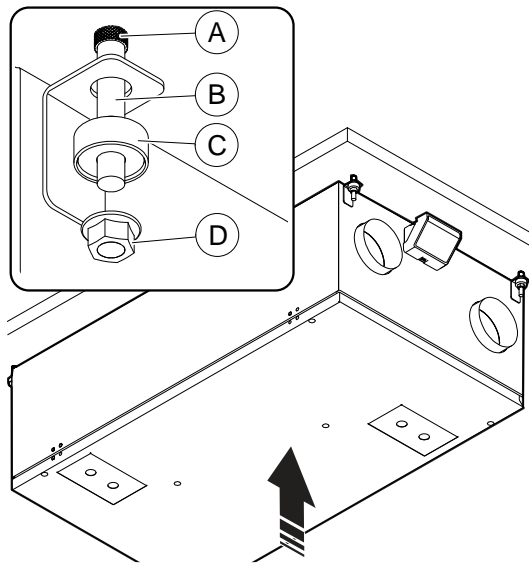
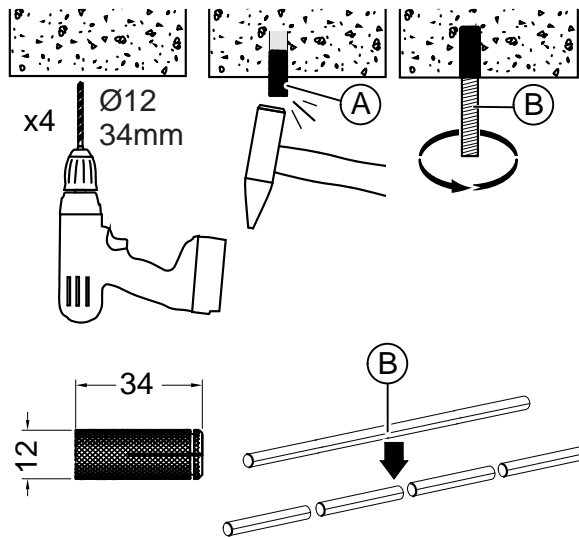
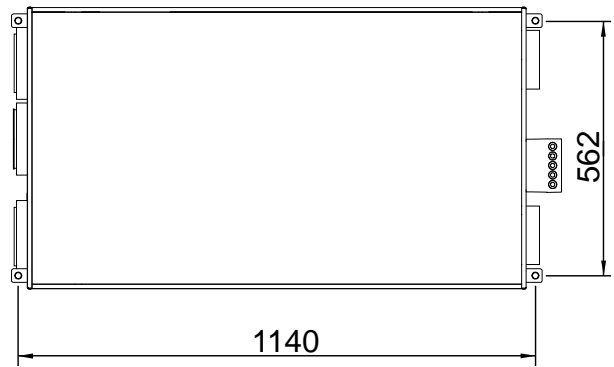
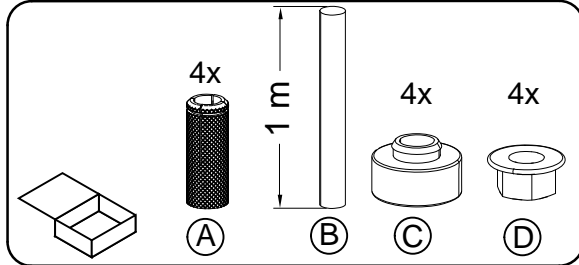
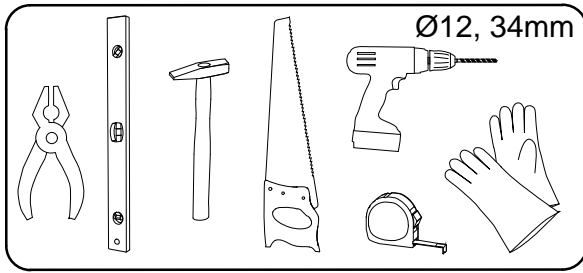

Make sure that the surface is flat and that it supports the weight of the unit. Perform the installation in accordance with local rules and regulations.

Follow the ventilation drawing when connecting the unit to the duct system.

6.1 Ventilation Duct Connection and Insulation

Important

- Always cover the ventilation ducts during construction period.
- Make sure there are no loose objects or impurities inside the ducts.

Install the ducts, supply air diffusers and air intake grilles as shown in the ventilation drawing.

- Supply air and extract air ducts must be insulated if located in cold places.
- Outdoor air and exhaust air ducts with cold air must be insulated if located in warm places (inside building's vapour barrier).

It is very important to insulate cold ducts and joints tightly without any gaps, otherwise there is a risk of condensation which may result in moisture damage.

Do not install the ducts directly against structural building elements to avoid sound propagation. Use acoustic insulation and sound attenuators.



Note:

The type of ventilation ducts and insulation differ for each building and climate zone. If the ventilation drawing is not provided, please contact your installer or place of purchase for recommendations.

6.2 Installation and Configuration of Accessories

Please follow instructions included with the accessory or consult “Service and Accessories Installation” manual which can be found in our online catalogue.

7 Electrical connections

7.1 Main circuit board layout

The SAVE VSR 200/B is equipped with built-in regulation and internal wiring.

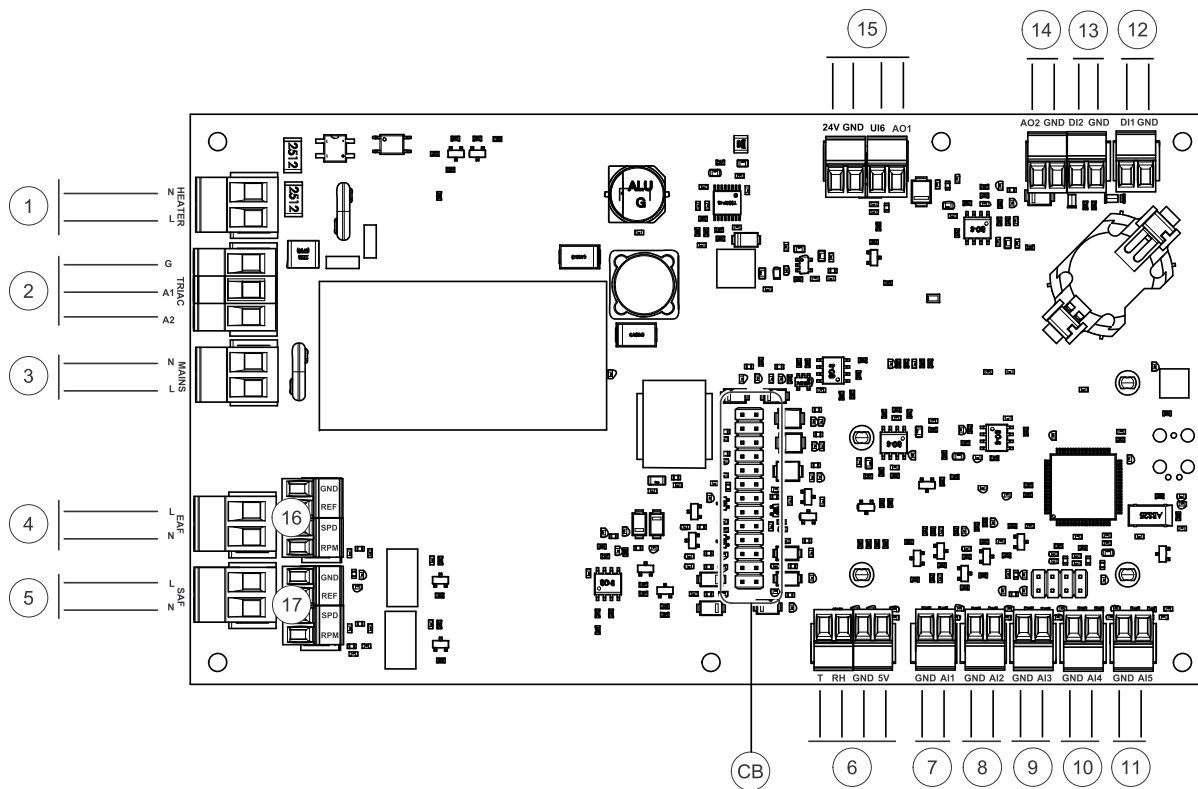

Fig. 6 Main circuit board connections

Position	Description
CB	Connection to the external connection box
1	Terminals for a heater
2	Terminals for a TRIAC
3	Terminals for the mains power supply
4	Terminals for power supply of extract air fan
5	Terminals for power supply of supply air fan
6	Terminals for internal relative humidity/temperature sensor
7	Analog input 1 – Outdoor air sensor
8	Analog input 2 – Supply air sensor
9	Analog input 3 – Freely configurable
10	Analog input 4 – Freely configurable / Overheat temperature sensor (units with heater)
11	Analog input 5 – Freely configurable

Position	Description
12	Digital input 1 – Rotor guard sensor (only for VSR, VTR models)
13	Digital input 2 – Freely configurable / Cooker hood (VTR 150/K unit)
14	Analog output 2 – Freely configurable / Electrical heater controller (VTC 700 unit)
15	Analog output 1 – Rotary heat exchanger control signal (for VSR, VTR type models) / Damper control signal (for VTC, VSC type models), UI6 – Bypass damper feedback signal (for VTC, VSC type models)
16	Terminals for speed control of extract air fan
17	Terminals for speed control of supply air fan

7.2 External connections (Connection board)

External connections to the main circuit board are done via connection board situated inside of the unit.

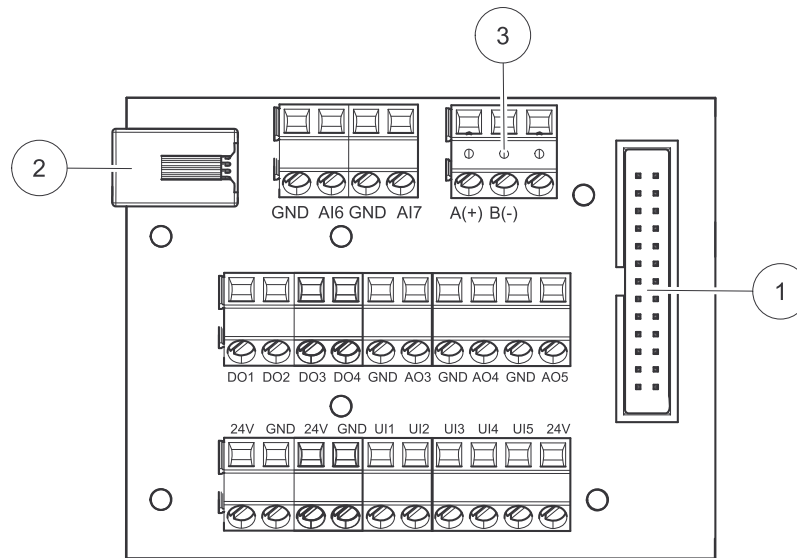

Fig. 7 External connection box and board

Position	Description
1	Connection to the main circuit board
2	Connection for external control panel (HMI) or Internet access module (IAM)
3	Modbus RS485 connection
AI6-7	Freely configurable Analog input. None/Input type selection in HMI.
DO1-4	Freely configurable digital output. DO2 default configuration: Outdoor-/Exhaust Air Damper DO3 default configuration: Activate Cooling DO4 default configuration: Sum Alarm
AO3-5	Freely configurable analog output. Actuator type 0-10V, 10-0V, 2-10V, 10-2V. AO3 default configuration: Heating (only for VTC 200/300/500/700, VTR 100/700 type models). AO4 default configuration: Cooling
UI1-5	Freely configurable universal input. Can be set as analog input (0-10 V) or a digital input (24 V). UI1 default configuration: Pressure guard UI2 default configuration: Cooker hood UI3 default configuration: Fire alarm UI4 default configuration: Refresh
24V	Maximum current 200mA at 24VDC +-10%.

8 Before Starting the System

When the installation is completed, check that:

- The unit is installed in accordance with the instructions
- Outdoor and exhaust air dampers and silencers are installed and that the duct system is correctly connected to the unit
- All ducts are sufficiently insulated and installed according to local rules and regulations
- Outdoor air intake is positioned with sufficient distance to pollution sources (kitchen ventilator exhaust, central vacuum system exhaust or similar)
- All external equipment is connected
- The unit is correctly wired

9 Commissioning

Follow the first startup instructions and fill in the **Commissioning record** as you go through the settings.

The Startup Wizard cannot be skipped.



Note:

If the SAVE LIGHT control panel is used, the start-up wizard is skipped and the factory settings are used.

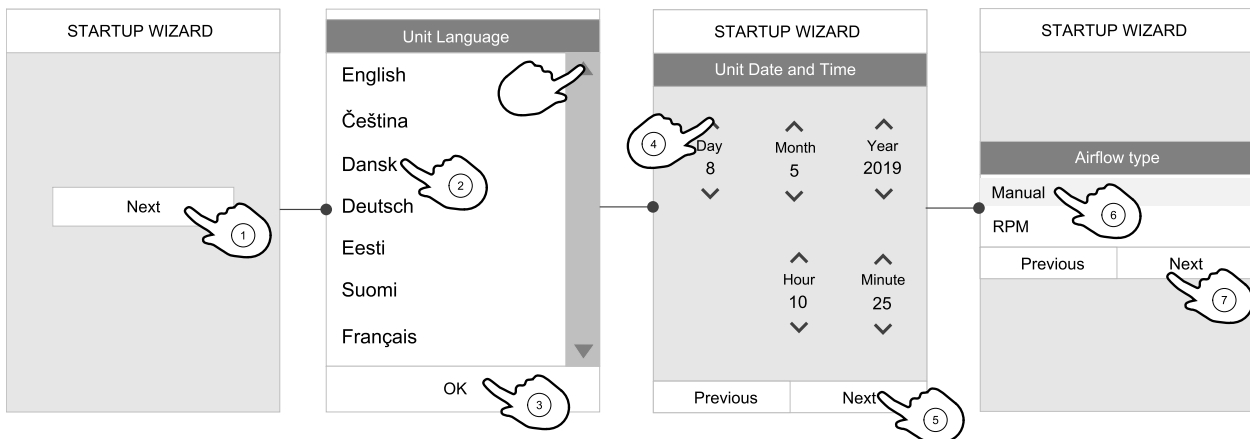

Select language, set the time and choose airflow control type. Select revolutions per minute as the type of airflow control only if these values are included with the device.

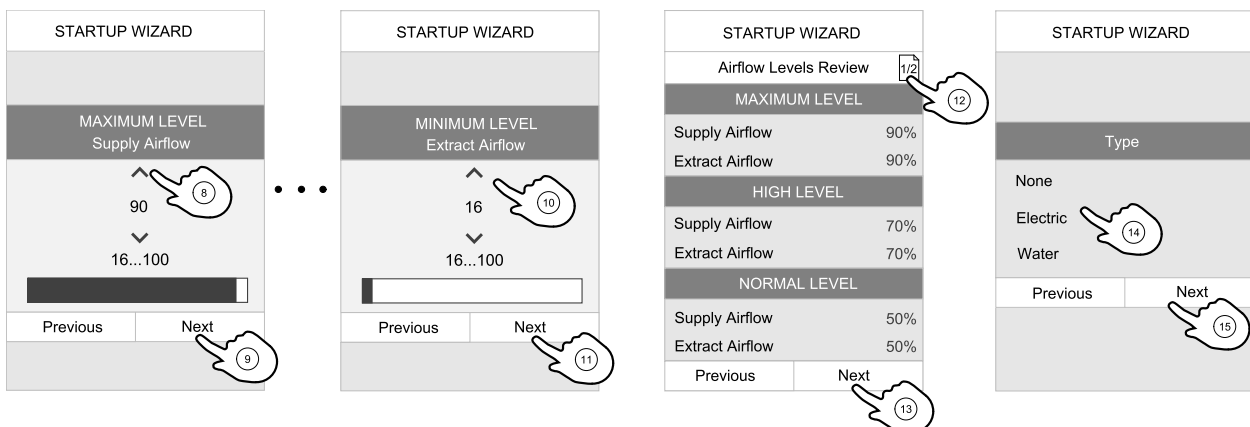

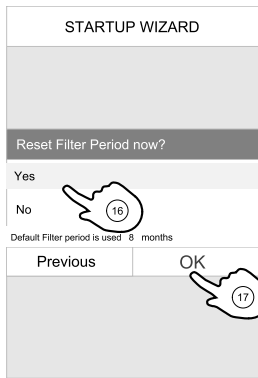

Set speed of supply and extract air fans for each level. When finished, review your settings. It is possible to go back to previous menus and make modifications. Choose heating type or none. Reset filter changer timer if necessary. Finish startup wizard with OK button. All additional changes post-startup wizard must be recorded in the **Commissioning record**.

10 Concluding Routines

Perform the following procedures before leaving the site:

1. Ensure that the product is operational and that no alarms are active.
2. If applicable, save the configuration backup.
3. Make sure that the **Commissioning record** is complete.
4. Collect all tools.
5. Inform the appropriate person that work is finished.
6. Follow the procedures for the return and disposal of replacement parts and the disposal of packing.

11 Disposal and recycling

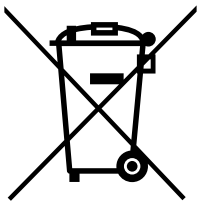

This product is compliant with the European WEEE Directive and related national waste legislation. When disposing of the unit, follow your local rules and regulations. This product packing materials are recyclable and can be reused. Do not dispose in household waste.



12 EU Declaration of Conformity

Manufacturer



Systemair UAB
 Linų st. 101
 LT-20174 Ukmergė, LITHUANIA
 Office: +370 340 60165
 Fax: +370 340 60166
 www.systemair.com

The manufacturer hereby confirms that

SAVE VSR 200/B

comply with all applicable requirements in the following directives and regulations.

Machinery Directive 2006/42/EC

Ecodesign Directive 2009/125/EC

327/2011 Requirements for fans above 125 W
 1253/2014 Requirements for ventilation units
 1254/2014 Energy labelling of residential ventilation units

Low Voltage Directive 2014/35/EU

EMC Directive 2014/30/EU

RoHS Directive 2011/65/EU, 2015/863/EU

The following harmonized standards are applied in applicable parts:

EN ISO 12100

Safety of machinery - General principles for design - Risk assessment and risk reduction.

EN 13857

Safety of machinery – Safety distances to prevent hazard zones being reached by upper or lower limbs.

EN 60204-1

Safety of machinery – Electrical equipment of machines – Part 1: General requirements.

EN 60335-1

Household and similar electrical appliances – Safety Part 1: General requirements.

EN 60335-2-40

Safety of household and similar electrical appliances - Part 2-40: Particular requirements for electrical heat pumps, air-conditioners and dehumidifiers.

EN 50106

Safety of household and similar appliances – Particular rules for routine tests referring to appliances under the scope of EN 60 335-1.

EN 60529

Degrees of protection provided by enclosures (IP Code).

EN 62233

Measurement methods for electromagnetic fields of household appliances and similar apparatus with regard to human exposure.

EN 61000-6-2

Electromagnetic compatibility (EMC) – Part 6-2: Generic standards – Immunity for industrial environments.

EN 61000-6-3

Electromagnetic compatibility (EMC) – Part 6-3: Generic standards – Emission standards for residential, commercial and light-industrial environments.

EN 13053

Ventilation for buildings – Air handling units – Rating and performance for units, components and sections.

EN 13142

Ventilation for buildings. Components/products for residential ventilation. Required and optional performance characteristics

The declaration applies only to product in the condition it was delivered in and installed in the facility in accordance with the included installation instructions. The insurance does not cover components that are added or actions carried out subsequently on the product.

The complete technical documentation is available.

Ukmergė, 27-09-2022

Nerijus Lapackas
 Technical Manager

Mindaugas Martišius
 Managing Director



Systemair UAB
Ling st. 101
LT-20174 Ukmergė, LITHUANIA

Phone +370 340 60165
Fax +370 340 60166

www.systemair.com