

SAVE VTC 200 – 1

User Manual

GB

Document in original language | 398086 · v1.1



© Copyright Systemair UAB
All rights reserved
E&OE

Systemair UAB reserves the rights to change their products without notice.
This also applies to products already ordered, as long as it does not affect the previously agreed specifications.

Contents

| | | | | |
|-------|--|----|--|--|
| 1 | Overview | 1 | | |
| 1.1 | General Description | 1 | | |
| 1.2 | Warranty | 1 | | |
| 1.3 | Type label | 1 | | |
| 2 | Warnings | 1 | | |
| 3 | Operation | 2 | | |
| 3.1 | SAVE LIGHT control panel | 2 | | |
| 3.1.1 | Indicators | 2 | | |
| 3.1.2 | To select airflow level | 2 | | |
| 3.1.3 | To cancel sleep mode | 3 | | |
| 3.1.4 | To reset the filter change time | 3 | | |
| 3.1.5 | To change control panel address (if more than one control panel is used) | 3 | | |
| 3.2 | SAVE TOUCH control panel / SAVE CONNECT | 4 | | |
| 3.2.1 | Common symbols | 4 | | |
| 3.2.2 | Home screen overview | 4 | | |
| 3.2.3 | Status bar and alarms | 4 | | |
| 3.2.4 | Quick Information screen | 5 | | |
| 3.2.5 | To select user mode | 5 | | |
| 3.2.6 | To change the temperature | 7 | | |
| 3.2.7 | To change the airflow | 7 | | |
| 3.2.8 | To set a week schedule | 8 | | |
| 4 | Maintenance | 9 | | |
| 4.1 | Maintenance Schedule | 9 | | |
| 4.2 | To access internal components | 9 | | |
| 4.3 | To clean the air chambers | 10 | | |
| 4.4 | To change filters | 10 | | |
| 4.4.1 | To reset the filter change time | 10 | | |
| 4.4.2 | To select a different filter kit | 11 | | |
| 4.5 | To clean the heat exchanger | 11 | | |
| 4.6 | Duct System Maintenance | 11 | | |
| 4.6.1 | Cleaning extract louvres and supply air diffusers | 11 | | |
| 4.6.2 | Checking the outdoor air intake | 12 | | |
| 4.6.3 | Checking the roof cowl (if fitted) | 12 | | |
| 4.6.4 | Checking and cleaning the duct system | 12 | | |
| 5 | Troubleshooting | 12 | | |
| 6 | Electrical data | 13 | | |
| 7 | Disposal and recycling | 13 | | |

1 Overview

1.1 General Description

This manual describes basic information how to operate and perform maintenance on the unit and the system it is connected to.

Read the instructions carefully and in its entirety.

For description of advanced settings and installation of accessories see *Service and Accessories Installation manual*.

All documents can be found in our online catalogue at www.systemair.com.

1.2 Warranty

For the assertion of warranty claims, the products must be correctly connected and operated, and used in accordance with the data sheets. Further prerequisites are a completed maintenance plan with no gaps and a commissioning report. Systemair will require these in the case of a warranty claim.

1.3 Type label

Before calling your service representative, make a note of the specification and production number from the type label, which can be found next to the external connections and inside of the unit.

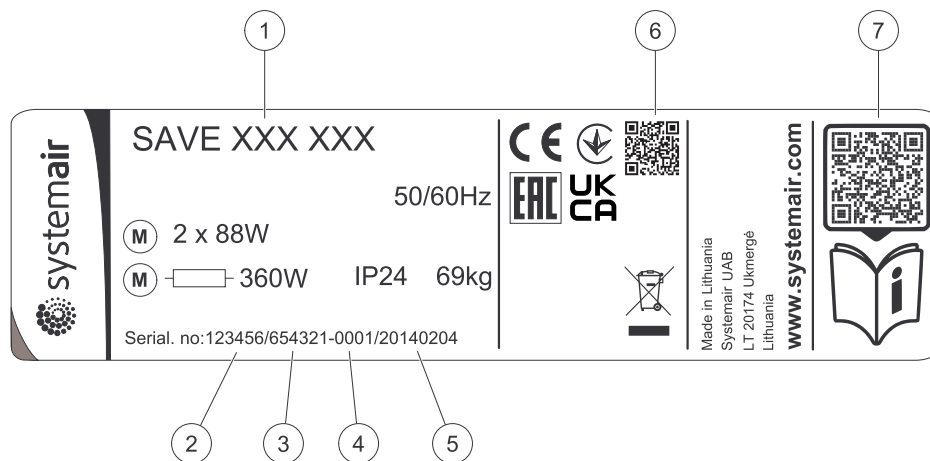

Fig. 1 Type label

| Position | Description |
|----------|---|
| 1 | Product code (product specification) |
| 2 | Product item number |
| 3 | Production order number |
| 4 | Serial number |
| 5 | Production date (YY.MM.DD) |
| 6 | Scannable code for manufacturing order (MO) number and software version |
| 7 | Scannable code for the spare parts list and documentation |

2 Warnings



Danger

- Make sure that the mains supply to the unit is disconnected before performing any maintenance or electrical work!
- All electrical connections and maintenance work must be carried out by an authorized installer and in accordance with local rules and regulations.



Warning

- This product is not intended to be used by children or people with reduced physical or mental ability or lack of experience and knowledge, if no instruction concerning the use has been given by the person responsible for their safety or that this person is supervising the operation. Children should be supervised so that they can not play with the product.
- Beware of sharp edges during mounting and maintenance. Use protective gloves.



Warning

- Although the mains supply to the unit has been disconnected there is still a risk of injury due to rotating parts that have not come to a complete standstill.

3 Operation

The unit can be controlled by one or more control methods:

- SAVE LIGHT control panel, refer to 2.
- SAVE TOUCH control panel, refer to 4.
- SAVE CONNECT, refer to 4.

3.1 SAVE LIGHT control panel

SAVE LIGHT is a basic control panel for SAVE series residential air handling units. SAVE LIGHT allows to change airflow levels and indicates when any alarm is present.

1. A button to increase airflow
2. A button to reduce airflow
3. Current airflow level/mode
4. Filter change LED
5. General alarm LED

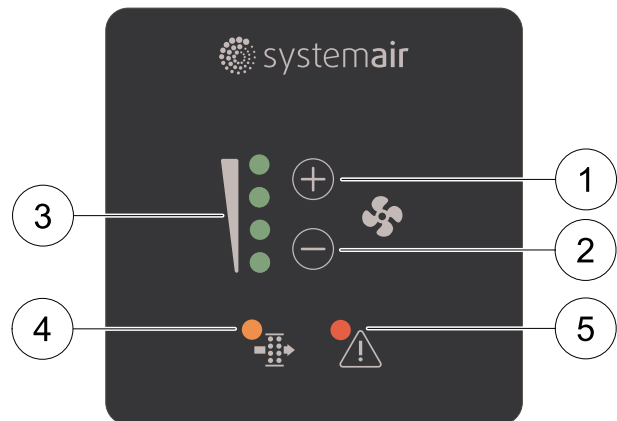
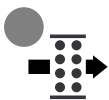

Fig. 2 Explanation of symbols

3.1.1 Indicators



General alarm LED shows when any alarm has occurred. Alarm type is not specified. It is not possible to acknowledge alarms from the SAVE LIGHT control panel. Please check SAVE TOUCH control panel or contact your local technical service provider.







The filter change LED shows when filters have to be replaced. Filters cannot be cleaned and must be changed as necessary. This is normally done 2–3 times per year depending on the air pollution at the installation site.

3.1.2 To select airflow level

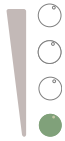
LEDs show current airflow level (figure 2, pos. 3).

- Press \oplus button to increase the airflow.
- Press \ominus button to decrease the airflow.

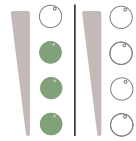
| Off | Low (Minimum) | Normal | High | Refresh (Maximum) | Auto – flashing slowly |
|---|---|---|---|--|--|
|  |  |  |  |  |  |
| The fan can be set to Off by activating Manual Fan Stop function in Service menu. | Fan speed – 25% | Fan speed – 45% | Fan speed – 70% | Sets speed of both supply and extract air fans to Maximum levels to replace indoor air with a fresh air in a short period of time. The unit returns to previously active mode after 1 hour when in the Refresh mode. | Automatic airflow control. Available only when Week Schedule, Demand Control functions are active or Fan Control setting is set to External. |



Note:

- Minimum and Maximum airflow can only be activated by a signal from an external source.
- Auto mode or Manual Fan Stop function can be enabled using the SAVE TOUCH control panel or a mobile application.
- It is **not** recommended to set fan to Off in standard households. If manual fan stop is activated, the unit should be provided with dampers in exhaust and fresh air ducts to avoid cold draught and risk of condensation when the unit has been stopped.

3.1.3 To cancel sleep mode

Press any button to cancel the sleep mode. SAVE LIGHT returns to the sleep mode after 3 minutes of inactivity.

All control panel lights are off during sleep mode. The sleep mode is active from 9:00 PM to 7:00 AM (based on time of the air handling unit).



3.1.4 To reset the filter change time

Push and hold  and  buttons for 3 seconds to reset the filter timer (filter change LED will turn off).

3.1.5 To change control panel address (if more than one control panel is used)

If more than one SAVE LIGHT control panel is used, the address of other control panels must be changed.

Each control panel must have it's own unique address number. No control panel should have the same address value to function properly.

1. Push and hold  button for 10 seconds to see a current control panel address value.
2. Press  button to increase and  button decrease the value.

Address value can be changed from 6 to 10, default value is 10.

| Address value | Indication |
|---------------|----------------------------|
| 6 | Low airflow LED is on |
| 7 | Normal airflow LEDs are on |
| 8 | High airflow LEDs are on |
| 9 | Refresh mode LEDs are on |
| 10 | All LEDs are on |





3.2 SAVE TOUCH control panel / SAVE CONNECT

Settings are done by touching the icons or options. The touch screen is sensitive and it is not necessary to press too hard.

SAVE CONNECT solution (mobile application and Internet access module) has a similar menu structure and functionality as SAVE TOUCH control panel, so this section can also be used as a guide for the mobile application.

3.2.1 Common symbols

The following selection symbols are common and are present in most menu pages:

- | | | | |
|---|--|---|---|
|  | Back button to return to a previous menu, located at the upper left corner |  | On and Off slider to activate or deactivate a function. White bubble – function is inactive, green bubble – function is active. |
|  | Up arrow to increase a value | CANCEL | Button to cancel changes |
|  | Down arrow to decrease a value | SET/OK | Buttons to confirm changes |

Some menus have more than one page. Touch page indicator in the top right corner to go to the next page. The first number indicates current page number and the second number indicates a total number of pages available.

Many options show up in a form of the pop-up window. Select the option from the displayed list in the pop-up window and press OK to confirm selection.

3.2.2 Home screen overview

1. Menu
2. Active user mode
3. Temperature settings
4. Airflow settings
5. Alarms and warnings
6. Status line
7. Outdoor temperature

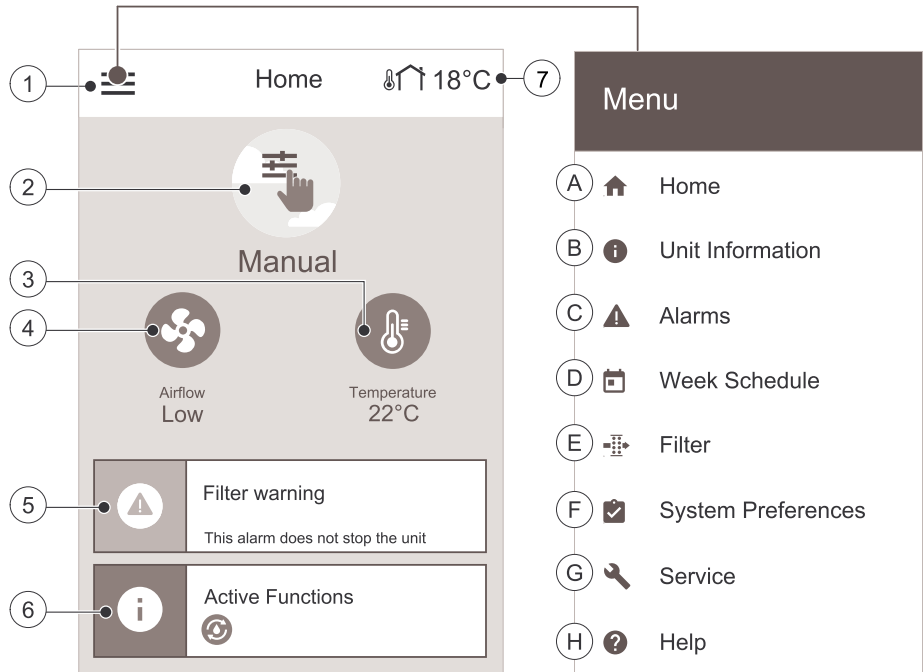

- | | |
|---|---|
| A. Return to home screen | E. Check and change remaining time till filter change |
| B. Basic read-only information about the unit | F. General system preferences |
| C. Currently active alarms and alarm history | G. Configuration of all system parameters |
| D. Configure and check week schedule | H. Help and troubleshooting menu |

3.2.3 Status bar and alarms

Status bar indicates all currently active functions. Touch the status bar to see descriptions of active functions in more detail.

 For more information about user modes and functions, please check **Help** menu.

Touch the alarm bar on the home screen to see all active alarms.

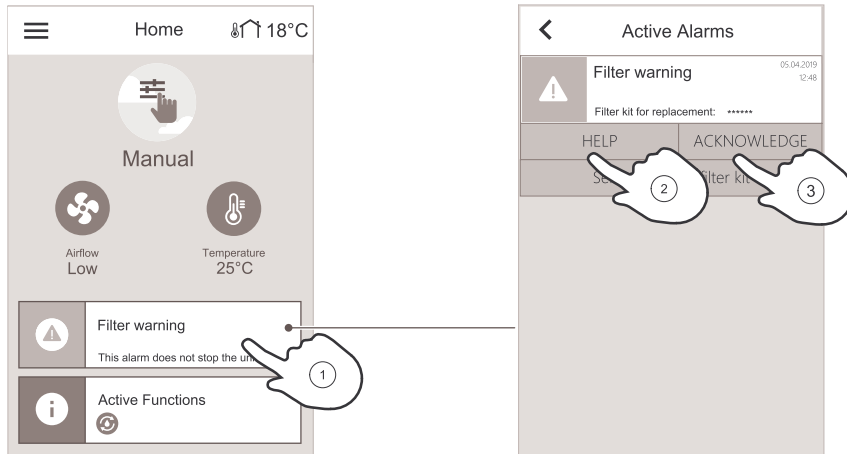

Touch **HELP** button to know more about the alarm. To clear the alarm, touch **ACKNOWLEDGE** button.



Note:

The underlying cause of the alarm must be resolved first otherwise the alarm will appear again. If the problem continues contact your installation company or place of purchase.

3.2.4 Quick Information screen

Quick information screen can be shown instead of a sleep mode screen.

Quick information screen shows the following information:

1. Time
2. Outdoor temperature
3. Current User mode / Alarm
4. Fan speed
 - – off, ●○○ – Minimum/Low, ●●○ – Normal, ●●● – High/Maximum
5. Supply air temperature
6. Relative humidity (if configured)
7. CO₂ sensor value (if configured)

Quick Information screen can be enabled or disabled in menu **System Preferences** -> **Display Settings** -> **Quick Info** screen.

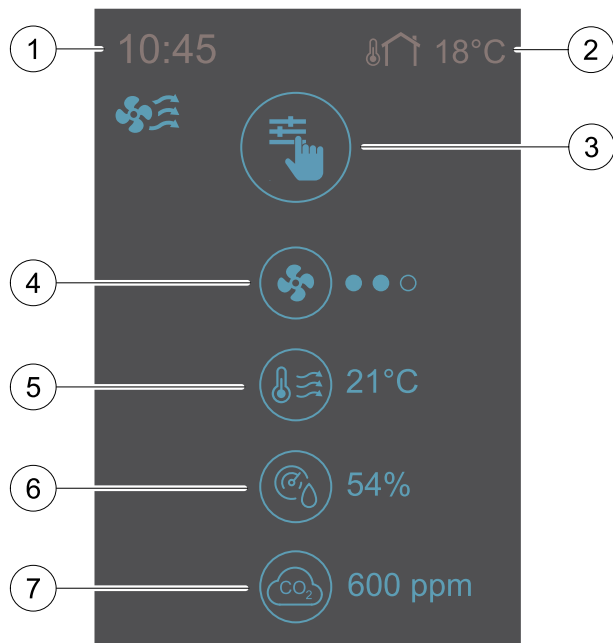

3.2.5 To select user mode



For more information about user modes and functions, please check **help** menu.

The top circle on the home screen indicates a currently active user mode. Touch the symbol to change the mode.

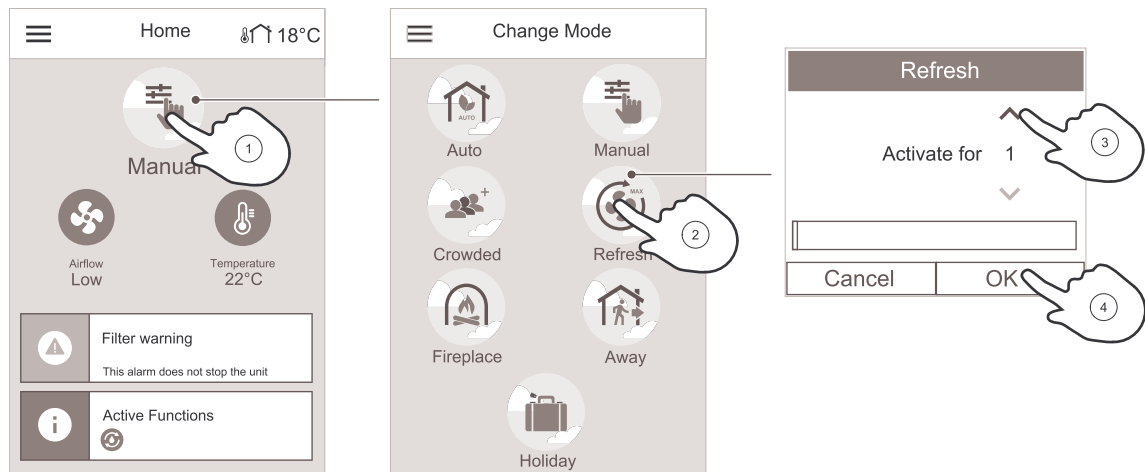

Duration have to be set for temporary user modes. SAVE VTC 200 – 1 will return to its previous working mode after the set time expires.



Note:

AUTO mode is available for selection only if the optional Demand Control, Week Schedule and/or external fan control functions are activated.

3.2.5.1 Permanent modes



Permanent modes are always active unless interrupted by temporary modes, activated user functions or alarms:

| Icon | Text | Description |
|------|--------|---|
| | Auto | Automatic airflow control. AUTO mode is available for selection when Demand Control, Week Schedule and/or external fan control functions are configured, otherwise AUTO mode icon won't be visible in active user modes menu. AUTO mode activates Demand Control, Week Schedule and/or external fan control functions. Demand is available to choose as airflow setting in Week Schedule. |
| | Manual | Manual selection of airflow levels. The unit can be set run at one out of four available airflow speeds: OFF/Low/Normal/High. Note: The fan can be set to OFF by activating Manual Fan Stop function in Service menu. |

3.2.5.2 Temporary modes

Temporary modes are active only for a set period of time unless interrupted by active user modes, activated user functions or alarms:

| Icon | Text | Description |
|------|---------|---|
| | Holiday | Sets speed of both supply and extract air fans to Low levels when user is away from home for a long period of time. ECO mode is active. Set duration in days. |
| | Crowded | Sets speed of both supply and extract air fans to maximum High levels and temperature setpoint offset to -3 K when apartment is more crowded than usual. Default temperature setpoint offset is -3 K. Set duration in hours. |
| | Away | Sets speed of both supply and extract air fans to Low levels when user is away from home for a short period of time. ECO mode is active. Set duration in hours. |

| Icon | Text | Description |
|---|-----------|--|
|  | Refresh | Sets speed of both supply and extract air fans to Maximum levels to replace indoor air with a fresh air in a short period of time. Set duration in minutes. |
|  | Fireplace | Sets speed of supply air fan to High level and extract air fan to Low level to increase air pressure within the apartment for better smoke extraction through the chimney. Set duration in minutes. |

Settings of all modes can be modified in *Service* menu.

3.2.6 To change the temperature

Touch the thermometer symbol on the home screen to open the temperature settings window.

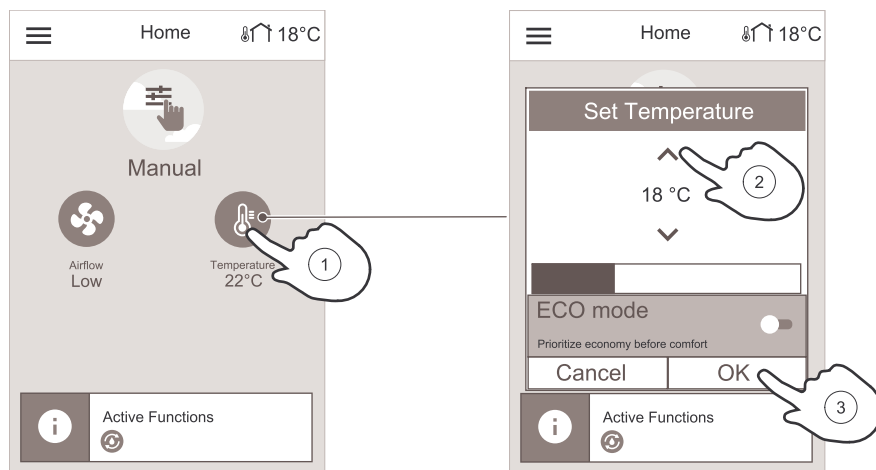

Use up and down arrows to increase or decrease a value. The default setting is 18 °C.

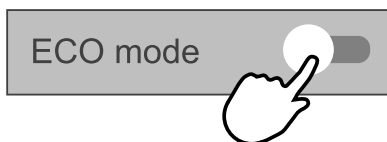

ECO mode is a power saving function which partially limits heater operation and can only be activated if a heater is installed.

3.2.7 To change the airflow

Touch the fan symbol on the home screen. In the open window use up or down arrows to increase or decrease the speed of fans.

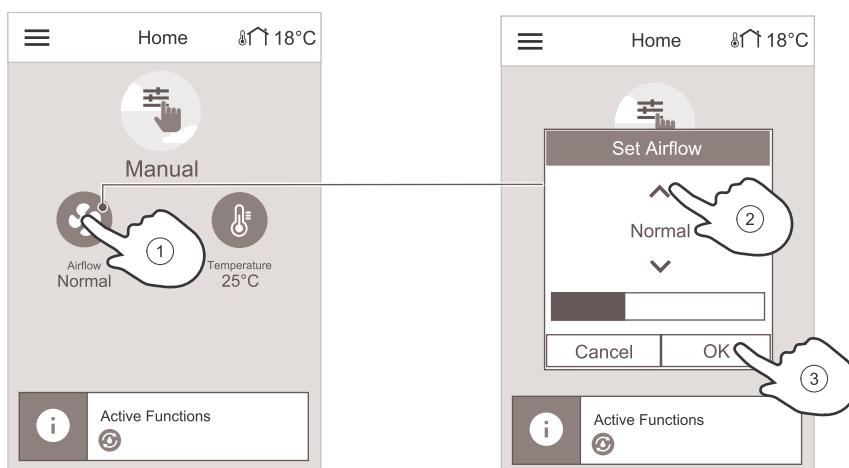

Note:

Airflow regulation is available only in *Manual* mode.

3.2.8 To set a week schedule

While in home screen, touch menu icon and select **Week Schedule**.

The menu is locked by default. Enter a password (default password is 1111).

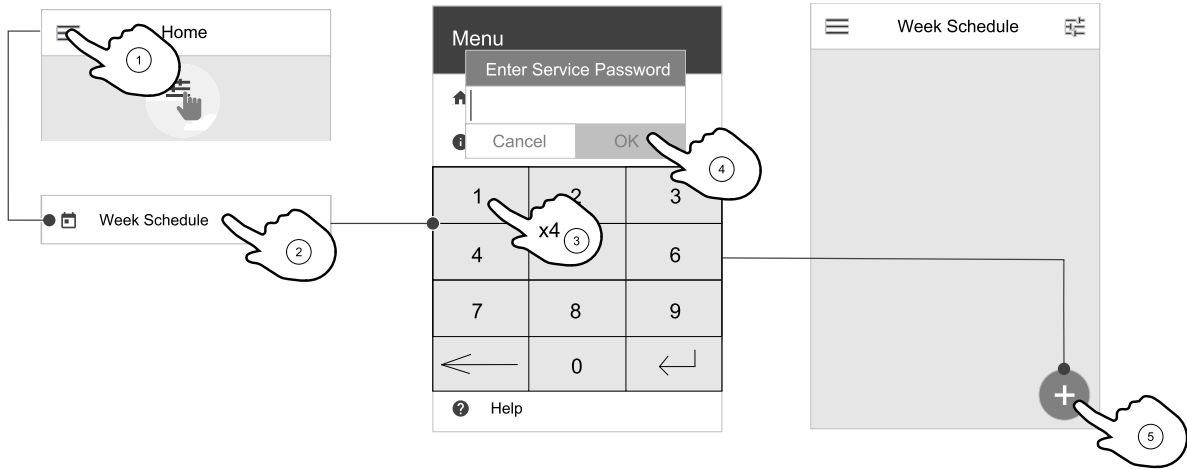

Touch icon at the bottom left corner of the screen to add a new schedule or press **EDIT** button to modify already added schedule.

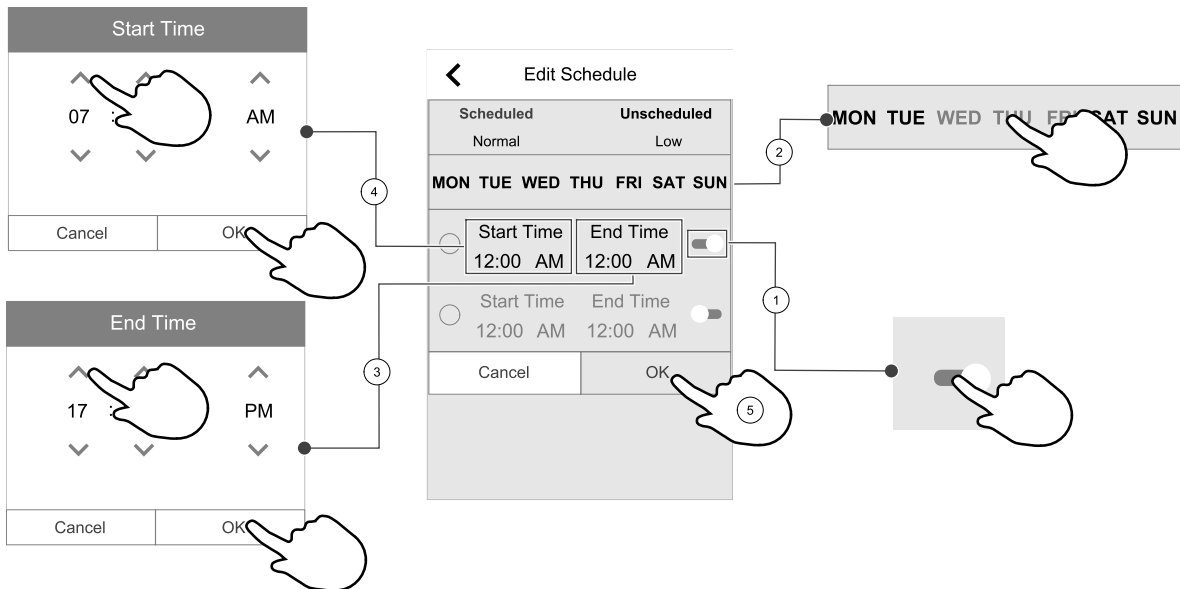

Touch the slider to the right to activate scheduled period.

Set the time. Touch the **START TIME** or **END TIME** values to change time. Use arrow buttons **^** and **v** to increase or decrease value. Confirm with **OK** button.



Note:

Scheduled time can start but never end at midnight (00:00). The latest **END TIME** period is 23:59. Scheduled time cannot go to the next day.
 12 or 24 hour time format can be changed in **System Preferences** menu.
Week Schedule is active only during **AUTO** mode.

If necessary, activate second scheduled period and set up time.

Once time is set, click on the day(s) when schedule should be active. It is possible to set a separate schedule for each day. Already scheduled days are not available for selection for new schedules.

Confirm schedule with **OK** button.

3.2.8.1 To schedule airflow settings

Touch settings icon to go to SCHEDULE AIRFLOW SETTINGS menu. In this menu set airflow level for scheduled and unscheduled periods. Available levels: Off, Low, Normal, High Or Demand.

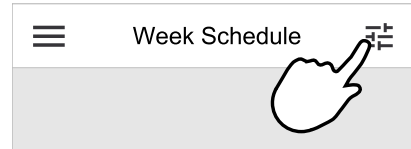

Set temperature setpoint offset for both periods (-10°C - 0°C).

Demand level is available only if Demand Control or External fan function is active.

4 Maintenance



Danger

- Make sure that the mains supply to the unit is disconnected before performing any maintenance or electrical work!

Warranty claims can only be made if maintenance work is carried out correctly and written evidence thereof is provided.

4.1 Maintenance Schedule

| Task | 6 months | 1 year | 3 years | When necessary |
|---|----------|--------|---------|----------------|
| General inspection | X | | | |
| Filter change | X | | | X |
| Fan cleaning | | X | | |
| Heat exchanger cleaning | | | X | X |
| Checking and cleaning louvres/ diffusers | | | | X |
| Checking and cleaning outdoor air intake | X | | | |
| Checking and cleaning roof cowl (if fitted) | X | | | |
| Cleaning of duct system | | | | X ¹ |

1. It is recommended to do this every 5 years and is normally carried out by authorized companies specialized in this area.

- Use original spare parts from Systemair only.
- Scan the code on the type label to find a spare part list.

4.2 To access internal components



Danger

- Make sure that the Mains supply to the unit is disconnected before performing any maintenance or electrical work!

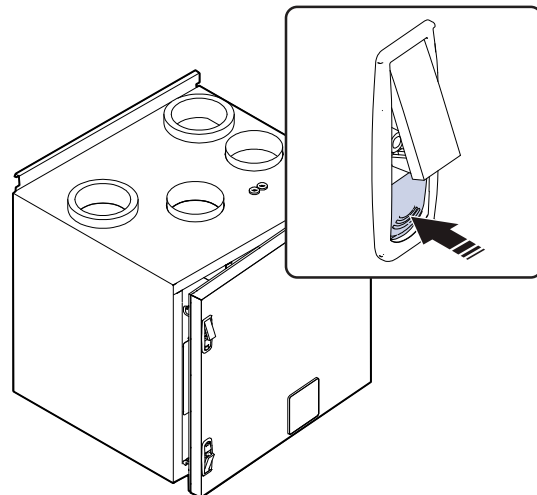

4.3 To clean the air chambers



Danger

- Make sure that the Mains supply to the unit is disconnected before performing any maintenance or electrical work!

Dust and dirt collect in the air chambers inside the product. The product must be cleaned periodically.

1. Stop the unit by disconnecting the mains.
2. Open the front hatch. See chapter 4.2.
3. Clean any dust or dirt. Use a vacuum cleaner and a damp cloth. Allow the product to dry.
4. Close and lock the front hatch and connect the unit to mains.

4.4 To change filters

The filters cannot be cleaned and must be changed as necessary. This is normally done 1–2 times per year depending on the air pollution at the installation site.

It is very important to change filters regularly for performance and energy efficiency of the unit.

When it's time to change the filters an alarm is shown on the control panel display. When this occurs do the following:

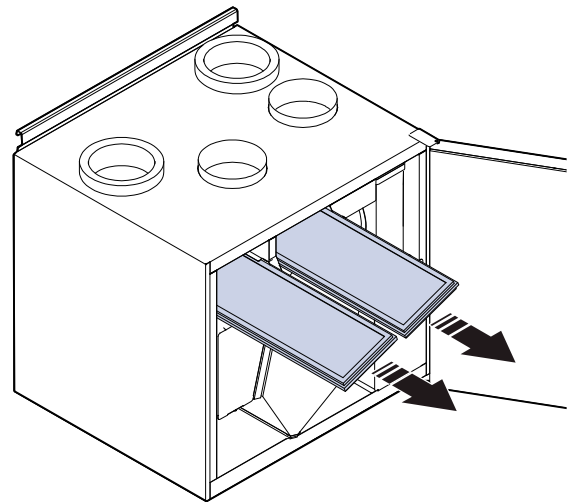

1. Stop the unit by disconnecting the mains.
2. Open the front hatch. See chapter 4.2.
3. Pull out the filters towards you. Some force may be needed.
4. Insert the new filters. Make sure that the correct filter types are inserted.
5. Close and lock the front hatch and connect the unit to mains.
6. Reset the filter time. See chapter 4.4.1.

4.4.1 To reset the filter change time

Once filter is changed, it is necessary to reset filter time. Go to **Filter** menu (see 3.2.2 *Home screen overview*, page 4, pos. E) or if filter alarm is present, click on alarm status line (see 3.2.2 *Home screen overview*, page 4, pos. 5) and select **CHANGE FILTER**, in the pop up menu define a new filter period and press **OK** to confirm selection.

Filter time is now reset.



Note:

The menu is locked by default. Enter a password (default password is 1111).

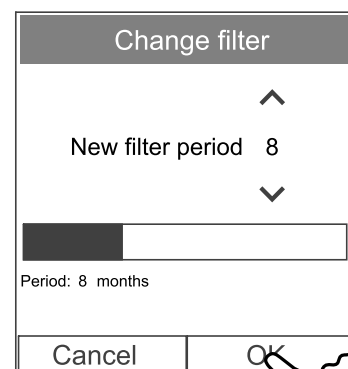

4.4.2 To select a different filter kit

Standard filters are designed for good outdoor air quality. It is possible to select and order filter kits for poorer air quality environment.

To change filter kit type

1. Touch **Select different filter kit** button in the alarm menu.
Alternatively, go to **Filter** menu (3.2.2 *Home screen overview*, page 4, pos. E).
2. Select filter kit from the list.
3. Touch **OK** button.

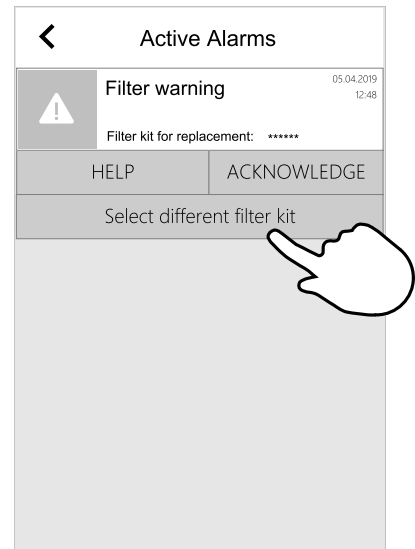

4.5 To clean the heat exchanger



Danger

- Make sure that the Mains supply to the unit is disconnected before performing any maintenance or electrical work!



Warning

- Beware of sharp edges during mounting and maintenance. Use protective gloves.

Even if the required maintenance is carried out, dust will build up in the exchanger block. It is therefore of vital importance for the upkeep of a high efficiency that the exchanger block is removed from the unit and cleaned periodically as described below. Clean the heat exchanger at least every 3 years or when required.

1. Stop the unit by disconnecting the mains.
2. Open the front hatch. See chapter 4.2.
3. Pull out the exchanger using the strap at the front.
4. Gently vacuum the heat exchanger.
5. Remount the heat exchanger.
6. Close and lock the front hatch and connect the unit to mains.

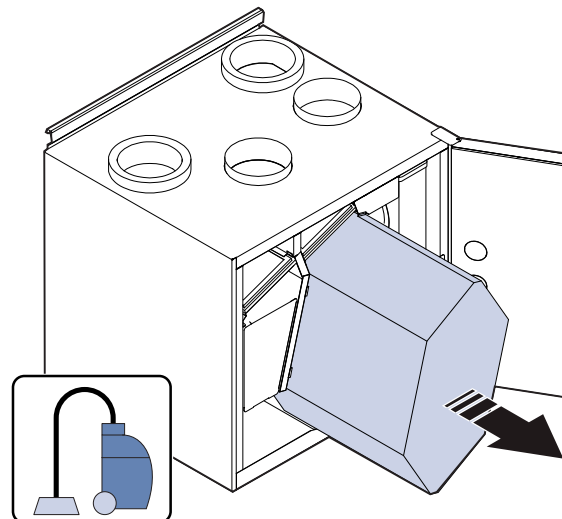

4.6 Duct System Maintenance

4.6.1 Cleaning extract louvres and supply air diffusers

The system supplies fresh air to your home and extracts the used indoor air via the duct system and diffusers/louvres. Diffusers and louvres are mounted in ceilings/walls in bedrooms, living room, wet rooms, WC etc. Remove diffusers and louvres and wash in hot soapy water as required (diffusers/louvres must not be exchanged). Cleaning of diffusers/louvres can be done as necessary.

4.6.2 Checking the outdoor air intake

Leaves and pollution could plug up the air intake grille and reduce the capacity. Check the air intake grille, and clean as necessary. It is recommended to do this at least twice a year.

4.6.3 Checking the roof cowl (if fitted)

The roof cowl (if fitted) connected to the exhaust air duct needs to be checked at least twice a year and cleaned if necessary.

4.6.4 Checking and cleaning the duct system

Dust and grease deposits may build up in the duct system, even if required maintenance such as changing of filters is being carried out. This will reduce the efficiency of the installation.

The duct runs should therefore be cleaned/changed when necessary. Steel ducts can be cleaned by pulling a brush soaked in hot soapy water through the duct via diffuser/louvre openings or special inspection hatches in the duct system (if fitted).

It is recommended to do this every 5 years and is normally carried out by authorized companies specialized in this area.

5 Troubleshooting

If problems should occur, please check the items below before calling your service representative.

Fans do not start

1. Check the control panel for alarms.
2. Check that all fuses and fast couplings are connected (main power supply and fast couplings for supply and extract air fans).
3. Check the week schedule. Fans may be set to OFF in the Schedule airflow settings menu.

Reduced airflow

1. Check the control panel for alarms. Some alarms can reduce the airflow to LOW if active.
2. The unit could be in defrost mode. This reduces the fan speed and in some cases shuts down the supply air fan completely during the defrosting cycle. The fans go back to normal after defrosting. There should be a defrosting function icon visible on the home screen if defrosting is active.
3. Speed of fans is linearly reduced when the outdoor air temperature is below 0°C and an outdoor airflow compensation function is enabled.
4. Check if temporary user mode that reduces airflow is not activated, for example AWAY, HOLIDAY, etc. Also check digital inputs Central Vacuum Cleaner and Cooker Hood.
5. Check the airflow settings in the control panel.
6. Check week schedule settings (chapter 3.2.8).
7. Check filters. Is change of filters required?
8. Check diffusers/louvres. Is cleaning of diffusers/louvres required?
9. Check fans and heat exchange block. Is cleaning required?
10. Check if the buildings air intake and roof unit (exhaust) have been clogged.
11. Check visible duct runs for damage and/or build up of dust/pollution.
12. Check diffuser/louvre openings.

The unit cannot be controlled (control functions are stuck)

1. Reset control functions by disconnecting mains power for at least 10 seconds.
2. Check the modular contact connection between the control panel and the main printed circuit board.

Low supply air temperature

1. Check the control panel for alarms.
2. Check the active user functions on the control panel if defrosting function is running.
3. Check set supply air temperature on the control panel.
4. Check if ECO mode is activated on the control panel (it is a power saving function and prevents the heater from activating).

5. Check if user modes **Holiday**, **Away** or **Crowded** are activated on the control panel or via a hardwired switch.
6. Check the analogue inputs in the service menu to verify that the temperature sensors are functioning correctly.
7. In case of installed electrical/other re-heater battery: Check if the overheat protection thermostat is still active. If necessary, reset by pressing the red button on the front plate of the electrical re-heater.
8. Check if the extract filter must be changed.
9. Check if the unit has a re-heater battery connected. At very cold outdoor conditions an electrical or water heating battery might be necessary. A re-heater battery can be acquired as an accessory.

Noise/vibrations

1. Clean fan impellers.
2. Check that the screws holding the fans are tightened.
3. Check that the anti vibration lists are fitted to the mounting bracket and to the back of the unit.

6 Electrical data

| | |
|-------------------------|-------|
| Fans | 162 W |
| Total power consumption | 166 W |
| Fuse | 10 A |

Voltage 230V 1~, 50Hz

7 Disposal and recycling

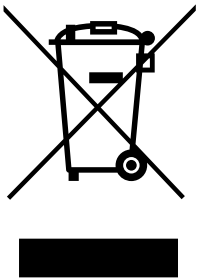

This product is compliant with the European WEEE Directive and related national waste legislation. When disposing the unit, follow your local rules and regulations. This product packing materials are recyclable and can be reused. Do not dispose in household waste.



Systemair UAB
Ling st. 101
LT-20174 Ukmergė, LITHUANIA

Phone +370 340 60165
Fax +370 340 60166

www.systemair.com