

OPERATION AND INSTALLATION MANUAL

SYS RM 05
Infrared Remote Controller

Thank you for purchasing the remote controller.
This manual describes the safety precaution requirement of using this product.

Thank you for purchasing this remote controller. Carefully read this OPERATION AND INSTALLATION MANUAL before using the controller. It will tell you how to use the controller properly and help you if any trouble occurs. After reading the manual, please keep it for future reference.

Contents

Installation	1
1. Installation Precautions	1
2. Installation Accessories	3
3. Dimensions of Remote Controller and Bracket	3
4. Installation and Fixing	4
5. Replace the Batteries	5
Operating the Remote Controller	7
1. Using Precautions	7
2. Model and Key Parameters	8
3. Button Names and Functions	9
4. Name and Function on Display Screen	11
5. Operating Methods	12
5.1 On/Off Operations	12
5.2 Mode and Temperature Operations	12
5.3 Fan Speed Operations	13
5.4 Fan Direction Operations	14
5.5 Swing Operations	14
5.6 IDU Display Operations	15
5.7 Silent Mode Operations	16
5.8 ECO Operations	16
5.9 Timer On/Off Operations	16
5.10 Setting Operations	18
5.11 Lock Buttons Operations	18
5.12 Cooling Only/Cooling and Heating Selection Operations	19
5.13 Auxiliary Heater Operations (reserved)	19
Field Settings	20
1. Indoor Unit Address Query and Setting	20
2. Parameter Configuration for Remote Controller	22

Installation

1. Installation Precautions

Safety Considerations

Please read this "Safety Considerations" carefully before installing Controller and be sure to install it correctly. After completing the installation, make sure the controller operates properly.

Please instruct the customer how to operate the controller and how to perform maintenance.

Meaning of Caution Symbols



Failure to observe these instructions properly may result in property damage or personal injury.

Information classified as **NOTE** contains instructions to ensure proper use of the controller.



- Ensure that nothing interrupts operation of the wireless remote controller.
- Ensure that the signal from the remote controller can easily be transmitted.
- Ensure that the operation display lamp and other indicator lamps can easily be seen.
- Ensure that there is neither a source of light nor a fluorescent lamp near the receiver.
- Ensure that the receiver is not exposed to direct sunlight.

Installation



WARNING

Precautions in handling remote controller

- Direct the transmitting part of the remote controller to the receiving part of the air conditioner.
- If something blocks the transmitting and receiving path of the indoor unit and the remote controller as curtains, it will not operate.

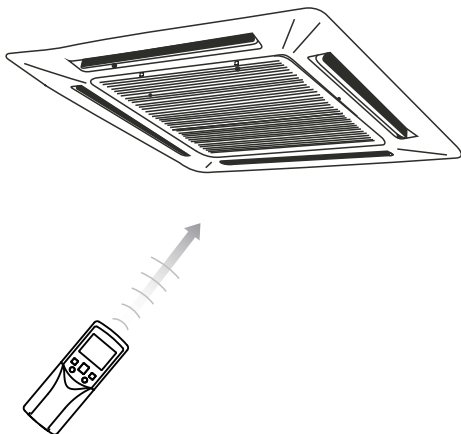

- Transmitting distance is approximately 7 m.
- 1 short beeps from the receiver indicates that the transmission is properly done.
- Do not drop or get it wet. It may get damaged.
- Never press the button of the remote controller with a hard, pointed object. The remote controller may get damaged.





Installation site

- It is possible that signals will not be received in rooms that have electronic fluorescent lighting. Please consult with the salesman before buying new fluorescent lights.
- If the remote controller operated some other electrical apparatus, move that machine away or consult your dealer.

Installation

2. Installation Accessories

- Please check that you have all the following parts.

No.	Name	Schematic	Qty
①	Screw lid		1
②	Philips head screw (M2.0*4.5)		2
③	AAA battery		2
④	Remote controller manual		1

3. Dimensions of Remote Controller and Bracket

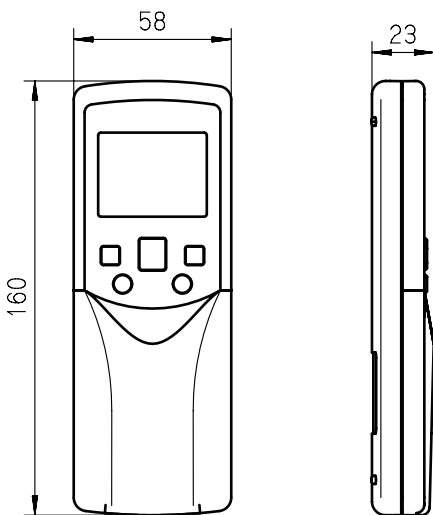

Figure 2.1 Dimensions of remote controller

Installation

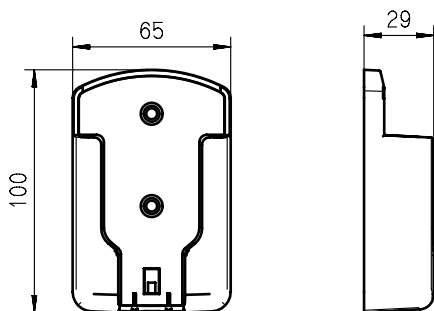

Figure 2.2 Dimensions of remote controller bracket

4. Installation and Fixing

1) Use the screws (accessories) to fix and secure the remote controller bracket in a stable position (see Figure 2.3);

Make sure you refer to "1. Installation Precautions" to determine the location.

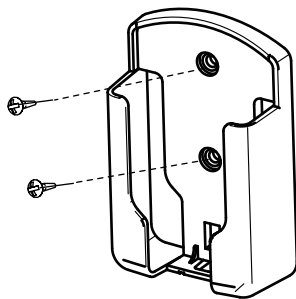

Figure 2.3

Installation

2) Slide the remote controller vertically down into the remote controller bracket (see Figure 2.4).

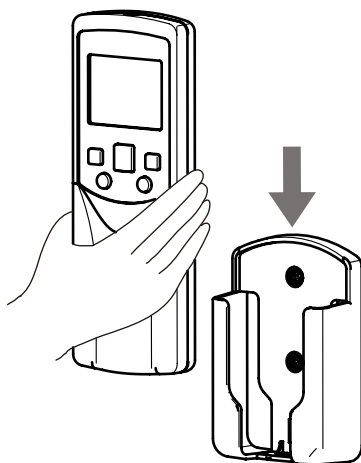

Figure 2.4

5. Replace the Batteries

1) Slide open the front cover of the remote controller in the direction indicated by the arrow (see Figure 2.5);

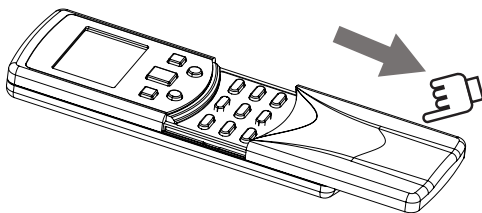

Figure 2.5

Installation

2) Remove the battery cover (see Figure 2.6);

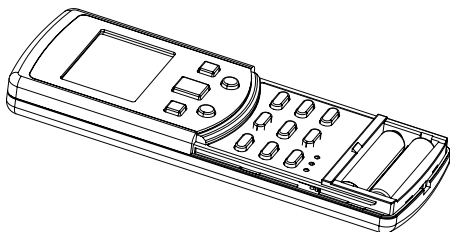

Figure 2.6

3) Take out the old battery and install two new AAA batteries matching the indicated polarity (see Figure 2.7). Close the battery cover.

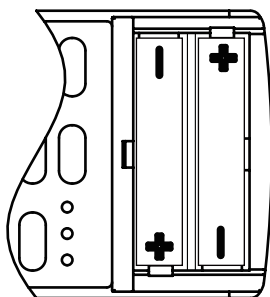

Figure 2.7

Operating the Remote Controller

1. Using Precautions

To gain full advantage of the controller's functions and to avoid malfunction due to mishandling, we recommend that you read this instruction manual carefully before use.

The precautions described herein are classified as **WARNING** and **CAUTION**. They both contain important information regarding safety. Be sure to observe all precautions without fail.



WARNING

Failure to follow these instructions properly may result in personal injury or loss of life.



CAUTION

Failure to observe these instructions properly may result in property damage or personal injury, which may be serious depending on the circumstances.

Information classified as **NOTE** contains instructions to ensure proper use of the controller.

After reading, keep this manual in a convenient place so that you can refer to it whenever necessary. If the controller is transferred to a new user, be sure also to hand over the manual.



WARNING

Note that prolonged, direct exposure to cool or warm air from the air conditioner or to air that is too cold or warm can be harmful to your physical body and health.

- Do not use pesticides, disinfectants and flammable sprays to spray directly on the remote controller as these may cause the device to become deformed.
 - If there is a fault with the remote controller, turn off the remote controller and contact your local agent.
 - Remove the dry batteries before cleaning or maintenance of the remote controller. Do not wash the controller with water.
-

Operating the Remote Controller



CAUTION

- Do not operate the device with wet hands to prevent water from entering the remote controller and damage the circuit board.
 - Do not use the air conditioner for purposes other than those for which it is intended. Do not use the air conditioner to cool precision instruments, food, plants, animals or works of art as this may adversely affect the performance, quality, and/or lifespan of the object concerned.
 - Ventilate the area from time to time. Be careful when you use the air conditioner with other heating equipment. Insufficient ventilation may result in oxygen deficiency.
-

2. Model and Key Parameters

Product Model	RM05B
Rated Voltage	3.0 V (AAA battery x 2)
Ambient Temperature	-5 to 43°C
Ambient Humidity	RH ≤ 90%

Operating the Remote Controller

3. Button Names and Functions

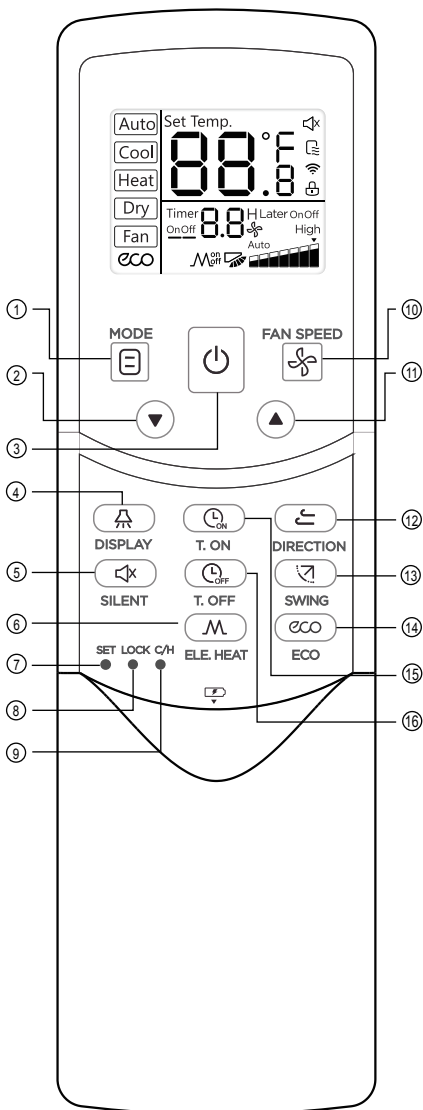



















Figure 3.1 External view of remote controller

Operating the Remote Controller

No.	Button	Function
①	 Mode	Set operating mode: Auto → Cool → Heat → Dry → Fan
②	 Adjust downwards	Adjust the temperature setting or timer (programmed time) downwards
③	 On/off switch	Switch on/off the unit
④	 Display	Turn on or off the display of the indoor unit
⑤	 Silent	Turn on/off the silent function
⑥	 Auxiliary heater	Turn on/off the auxiliary heater function
⑦	SET  Setting	Set fan speed and temperature adjustment steps.
⑧	LOCK  Lock	Lock or unlock the buttons.
⑨	C/H  Cooling Only/ Cooling and Heating Selection	Switch between Cooling Only, Cooling and Heating modes.
⑩	 Fan speed	Fan speed setting
⑪	 Adjust upwards	Adjust the temperature setting or timer (programmed time) upwards
⑫	 Fan direction	Adjust the direction of the louver
⑬	 Swing	Turn on/off the swing function
⑭	 ECO	Turn on/off the economic operation function
⑮	 Timer on	Set the time to turn on the unit
⑯	 Timer off	Set the time to turn off the unit

Operating the Remote Controller

Note:

- The buttons  and  are not available for first generation indoor units.

4. Name and Function on Display Screen

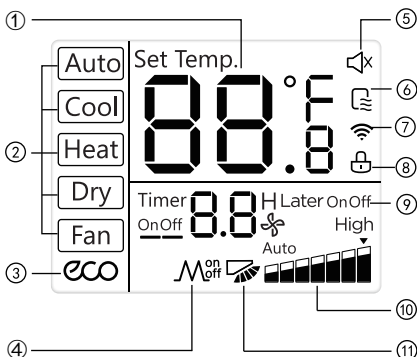

Figure 3.2 Display screen of remote controller



No.	Name	Display Function
①	Temperature	Displays current temperature setting
②	Operating mode	Displays the current operating mode
③	ECO	Shows that ECO function is on
④	Auxiliary heater	Shows that auxiliary heater is on
⑤	Silent mode	Shows that Silent is on
⑥	Power-on display	Indicates a unit is turned on
⑦	Signal transmission	Displays signal sent to the indoor unit from the remote controller

Operating the Remote Controller

⑧	Lock	Shows that the remote controller button is locked
⑨	Timer On/Off	Displays times to turn on/off the unit
⑩	Fan speed	Displays the current fan speed
⑪	Swing	Shows that Swing is on

5. Operating Methods

5.1 On/Off Operations

1) Press  (see Figure 3.3), and the remote controller displays the  icon on its screen. Indoor unit starts to run;

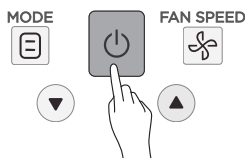





Figure 3.3

2) Press  again. The  icon disappears from the display screen of the remote controller, and the indoor unit stops running.

5.2 Mode and Temperature Operations

1) Press  (see Figure 3.4). Display screen shows the operating mode;

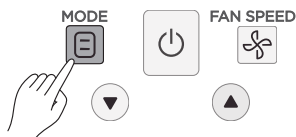



Figure 3.4

Operating the Remote Controller

2) Press  each time to change the operating mode according to the order shown in Figure 3.5;

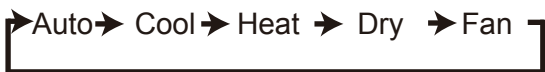





Figure 3.5

3) In Auto, Cool, Dry or Heat mode, press  and  to adjust the temperature setting. Press  and  to adjust the temperature by 1°C (default). Long press to change the temperature continuously.

Note:

- Fan speed cannot be adjusted in the Auto and Dry modes.
- Temperature setting cannot be adjusted in the Fan mode.

5.3 Fan Speed Operations

In Cool, Heat or Fan mode, press  to set the operating fan speed (see Figure 3.6).

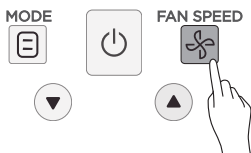

Figure 3.6

1) 7 fan speeds: The default in the remote controller is the mode with 7 fan speeds, where the Fan Speed will be adjusted in turn as shown in Figure 3.7;

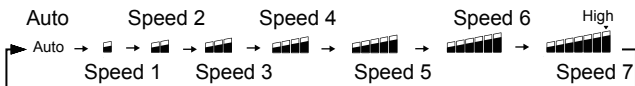

Figure 3.7

2) 3 fan speeds: Fan Speed will be adjusted in turn as shown in Figure 3.8.



Figure 3.8

Note: the default fan speed is 7 fan speeds, please refer to Field Setting to adjust the default fan speed.

Operating the Remote Controller

5.4 Fan Direction Operations

Press  to adjust the direction of the louver (see Figure 3.9).

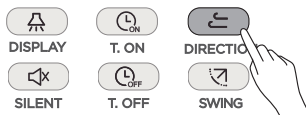





Figure 3.9

- 1) For second generation indoor units, there are 5 swing angles, and the louver swings by a particular angle each time the button is pressed;
- 2) For first generation of indoor units, the louver will swing by about 6 degrees each time the button is pressed.

Note:

- Only valid for indoor units with vertical louvers.
- When the unit is off, the  button is invalid. When the unit is turned off, the remote controller automatically turns off the louver direction function.

5.5 Swing Operations

- 1) When the unit is on. Press  (see Figure 3.10). Start the swing function, and the  icon will light up, and signal is sent to the indoor unit;

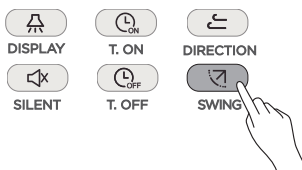



Figure 3.10

- 2) When the swing is on, press  to turn off this function.

Note:

- When the unit is turned off, the  button is invalid.
- Each time the swing signal is sent, the icon keeps lighting up for 15s and then disappears. The indoor unit remains swing operation.

Operating the Remote Controller

5.6 IDU Display Operations

The Display function is used to control the on/off state of the display in the indoor unit.



1) When the remote controller is in on or off state, press  (see Figure 3.11), and the display of the indoor unit lights up;





Figure 3.11

2) When the display of the indoor unit lights up, press  to turn off the light.

5.7 Silent Mode Operations

The Silent function is used by the remote controller to send the "Silent" signal to the indoor unit. The indoor unit automatically optimizes the noise it generates when it is in the "Silent" mode.

1) When the unit is in the Cool or Heat mode, press  (see Figure 3.12) to start the Silent function. Screen displays the  icon;

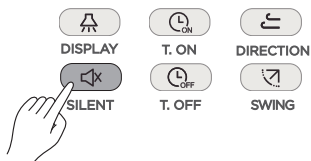





Figure 3.12

2) In Silent mode, press  to turn off the Silent function, and the  icon will disappear.





Note:

- Once it has been running for 8 hours,  will no longer light up, and the unit will exit the Silent mode.
- The Silent and ECO functions cannot be implemented at the same time.

Operating the Remote Controller

5.8 ECO Operations

The remote controller can send the ECO signal to the indoor unit when the unit is operating in Cool or Heat mode.

- 1) Press  (see Figure 3.13) to send the ECO signal to the indoor unit. The *eco* icon is displayed;
- 2) Then press ,  or  to exit the ECO function. The *eco* icon disappears.

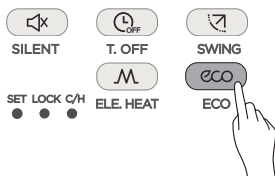

Figure 3.13

Note:

- In cooling mode, when ECO is set up, the Fan Speed is turned to Auto and the temperature is 26°C; in heating mode, when ECO is set up, the Fan Speed is turned to Auto and the temperature does not change.
- Once it has been running for 8 hours, *eco* will no longer light up, and the unit will exit the ECO mode.
- The Silent and ECO functions cannot be implemented at the same time.

5.9 Timer On/Off Operations

"Timer" is used to set the timed on/off state of indoor unit.

1) Timer On Operation:

- ① Press  (see Figure 3.14), and the remote controller will display "Timer On", and "0.0h Later On" will appear in the timer area. Adjust the Timer On settings now;

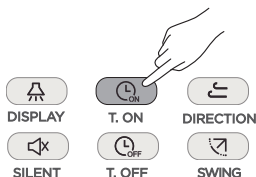





Figure 3.14

Operating the Remote Controller

- ② Press  or ,  to adjust the timer settings;
- ③ Once the adjustment is done, the timer information is sent to the indoor unit.

2) Timer Off Operation:

- ① Press  (see Figure 3.15), and the remote controller will display "Timer Off", and "0.0h Later Off" will appear in timer area. Adjust the Timer Off settings now;

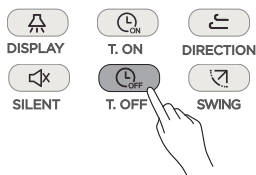





Figure 3.15

- ② Press  or ,  to adjust the timer settings;
- ③ Once the adjustment is done, the timer information is sent to the indoor unit.

Note:

- Long press the timer adjustment buttons to adjust the time in units of 0.5 hours. If the adjustment exceeds 10 hours, the changes will be in units of 1 hour, and the maximum time setting is 24 hours.
- Adjust the Timer On or Timer Off to 0.0h to cancel the Timer On or Timer Off settings.
- When the Timer settings have been completed, there may be a ± 15 minutes time difference when the buttons for adjustment, mode, fan speed and ECO are pressed again.
- The Timer On and Timer Off settings can be set at the same time.

Operating the Remote Controller

5.10 Setting Operations

Press ^{SET} ● to configure the remote controller parameters (see Figure 3.16) (for details, refer to the parameter configuration methods in Field Settings).



Figure 3.16

5.11 Lock Buttons Operations

Once the buttons on the remote controller are locked, all the other button operations are invalid except for Lock, Cooling Only/Cooling and Heating Selection and Group Address Setting.

1) Press ^{LOCK} ● to lock the buttons (see Figure 3.17) and the display will show the lock icon “”.

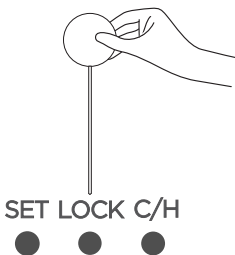



Figure 3.17

2) Press ^{LOCK} ● again, and the lock icon “” will disappear. Buttons are unlocked.

Operating the Remote Controller

5.12 Cooling Only/Cooling and Heating Selection Operations

1) In Cooling Only mode, press ^{C/H} ● to turn on the Cooling and Heating function. (see Figure 3.18)

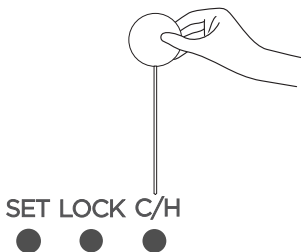

Figure 3.18

2) In Cooling and Heating mode, press ^{C/H} ● to turn on the Cooling Only function.

Note:

- Factory default setting is Cooling and Heating mode.

5.13 Auxiliary Heater Operations (reserved)

Field Settings

1. Indoor Unit Address Query and Setting

Long press ^{LOCK} ● for 5 seconds (see Figure 4.1) to enter the address settings page of the indoor unit. Long press the same button again for 5 seconds to exit the page.

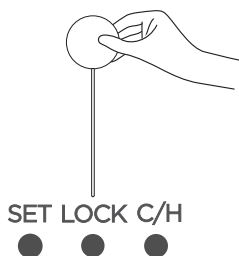



Figure 4.1

1) Indoor Unit Address Query:

Once in the address setting page, press  to enter the Send page. In Send page, press  to send the query command (see Figure 4.2), and the indoor unit display will show the IDU's current address.

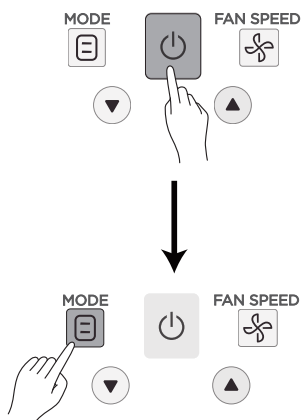





Figure 4.2

Field Settings

2) Indoor Unit Address Setting:

Once in the address setting page, press  to enter the Send page. In Send page, press  and  to adjust the address up and down respectively. Press  to send the address to the indoor unit. (See Figure 4.3)

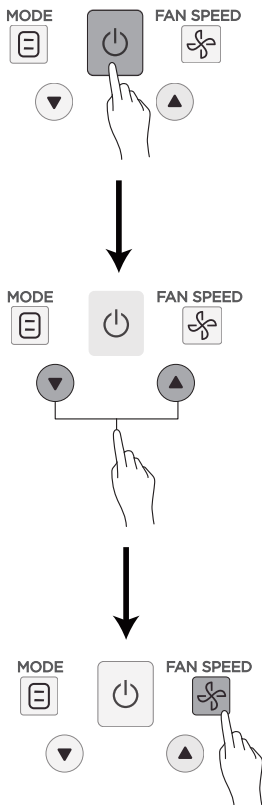





Figure 4.3

Field Settings

2. Parameter Configuration for Remote Controller

1) Configuration Method:

① Long press  and  at the same time for 5 seconds or press  ^{SET} to enter the parameter settings page (see Figure 4.4).

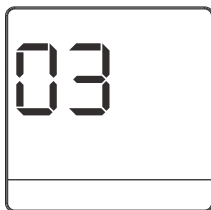



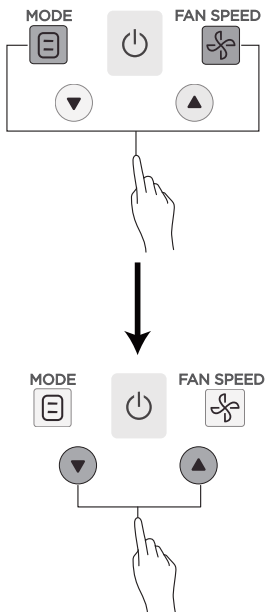

Figure 4.4

② Press  and  to adjust the parameter value;

③ Once the adjustment is done, press  or wait for 5 seconds to save the parameter settings. The operation sequence for the buttons is as shown in Figure 4.5.



Field Settings

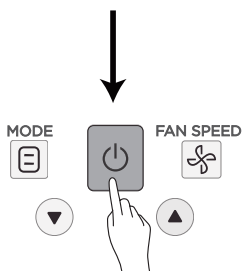

Figure 4.5

2) See Table 4.1 for details.

Table 4.1 Parameters of remote controller

Parameter	Parameter Definition
00	7 fan speeds, temperature adjustment step of 0.5°C
01	3 fan speeds, temperature adjustment step of 1°C
02	7 fan speeds, temperature adjustment step of 1°C (default parameter)
03	3 fan speeds, temperature adjustment step of 0.5°C

Note:

- For the first generation indoor units, please set the parameter to 01.

MD18U—001BW

16117000001594